

# Signal Processing Toolbox™

## User's Guide

**R2012b**

**MATLAB®**

## How to Contact MathWorks



[www.mathworks.com](http://www.mathworks.com) Web  
[comp.soft-sys.matlab](mailto:comp.soft-sys.matlab) Newsgroup  
[www.mathworks.com/contact\\_TS.html](http://www.mathworks.com/contact_TS.html) Technical Support



[suggest@mathworks.com](mailto:suggest@mathworks.com) Product enhancement suggestions  
[bugs@mathworks.com](mailto:bugs@mathworks.com) Bug reports  
[doc@mathworks.com](mailto:doc@mathworks.com) Documentation error reports  
[service@mathworks.com](mailto:service@mathworks.com) Order status, license renewals, passcodes  
[info@mathworks.com](mailto:info@mathworks.com) Sales, pricing, and general information



508-647-7000 (Phone)



508-647-7001 (Fax)



The MathWorks, Inc.  
3 Apple Hill Drive  
Natick, MA 01760-2098

For contact information about worldwide offices, see the MathWorks Web site.

*Signal Processing Toolbox™ User's Guide*

© COPYRIGHT 1988–2012 by The MathWorks, Inc.

The software described in this document is furnished under a license agreement. The software may be used or copied only under the terms of the license agreement. No part of this manual may be photocopied or reproduced in any form without prior written consent from The MathWorks, Inc.

FEDERAL ACQUISITION: This provision applies to all acquisitions of the Program and Documentation by, for, or through the federal government of the United States. By accepting delivery of the Program or Documentation, the government hereby agrees that this software or documentation qualifies as commercial computer software or commercial computer software documentation as such terms are used or defined in FAR 12.212, DFARS Part 227.72, and DFARS 252.227-7014. Accordingly, the terms and conditions of this Agreement and only those rights specified in this Agreement, shall pertain to and govern the use, modification, reproduction, release, performance, display, and disclosure of the Program and Documentation by the federal government (or other entity acquiring for or through the federal government) and shall supersede any conflicting contractual terms or conditions. If this License fails to meet the government's needs or is inconsistent in any respect with federal procurement law, the government agrees to return the Program and Documentation, unused, to The MathWorks, Inc.

### Trademarks

MATLAB and Simulink are registered trademarks of The MathWorks, Inc. See [www.mathworks.com/trademarks](http://www.mathworks.com/trademarks) for a list of additional trademarks. Other product or brand names may be trademarks or registered trademarks of their respective holders.

### Patents

MathWorks products are protected by one or more U.S. patents. Please see [www.mathworks.com/patents](http://www.mathworks.com/patents) for more information.

## Revision History

1988	First printing	New
November 1997	Second printing	Revised
January 1998	Third printing	Revised
September 2000	Fourth printing	Revised for Version 5.0 (Release 12)
July 2002	Fifth printing	Revised for Version 6.0 (Release 13)
December 2002	Online only	Revised for Version 6.1 (Release 13+)
June 2004	Online only	Revised for Version 6.2 (Release 14)
October 2004	Online only	Revised for Version 6.2.1 (Release 14SP1)
March 2005	Online only	Revised for Version 6.2.1 (Release 14SP2)
September 2005	Online only	Revised for Version 6.4 (Release 14SP3)
March 2006	Sixth printing	Revised for Version 6.5 (Release 2006a)
September 2006	Online only	Revised for Version 6.6 (Release 2006b)
March 2007	Online only	Revised for Version 6.7 (Release 2007a)
September 2007	Online only	Revised for Version 6.8 (Release 2007b)
March 2008	Online only	Revised for Version 6.9 (Release 2008a)
October 2008	Online only	Revised for Version 6.10 (Release 2008b)
March 2009	Online only	Revised for Version 6.11 (Release 2009a)
September 2009	Online only	Revised for Version 6.12 (Release 2009b)
March 2010	Online only	Revised for Version 6.13 (Release 2010a)
September 2010	Online only	Revised for Version 6.14 (Release 2010b)
April 2011	Online only	Revised for Version 6.15 (Release 2011a)
September 2011	Online only	Revised for Version 6.16 (Release 2011b)
March 2012	Online only	Revised for Version 6.17 (Release 2012a)
September 2012	Online only	Revised for Version 6.18 (Release 2012b)



## Filtering, Linear Systems and Transforms Overview

**1**

<b>Filter Implementation and Analysis</b> .....	1-2
Filtering Overview .....	1-2
Convolution and Filtering .....	1-2
Filters and Transfer Functions .....	1-3
Filtering with the filter Function .....	1-4
<b>The filter Function</b> .....	1-6
<b>Other Functions for Filtering</b> .....	1-8
Multirate Filter Bank Implementation .....	1-8
Anti-Causal, Zero-Phase Filter Implementation .....	1-9
Frequency Domain Filter Implementation .....	1-10
<b>Impulse Response</b> .....	1-12
<b>Frequency Response</b> .....	1-14
Digital Domain .....	1-14
Analog Domain .....	1-16
Magnitude and Phase .....	1-17
Delay .....	1-18
<b>Zero-Pole Analysis</b> .....	1-21
<b>Linear System Models</b> .....	1-23
Available Models .....	1-23
Discrete-Time System Models .....	1-23
Continuous-Time System Models .....	1-31
Linear System Transformations .....	1-32
<b>Discrete Fourier Transform</b> .....	1-34

<b>Filter Requirements and Specification</b> .....	2-2
<b>IIR Filter Design</b> .....	2-4
IIR vs. FIR Filters .....	2-4
Classical IIR Filters .....	2-4
Other IIR Filters .....	2-5
IIR Filter Method Summary .....	2-5
Classical IIR Filter Design Using Analog Prototyping .....	2-6
Comparison of Classical IIR Filter Types .....	2-9
<b>FIR Filter Design</b> .....	2-17
FIR vs. IIR Filters .....	2-17
FIR Filter Summary .....	2-18
Linear Phase Filters .....	2-18
Windowing Method .....	2-20
Multiband FIR Filter Design with Transition Bands .....	2-24
Constrained Least Squares FIR Filter Design .....	2-31
Arbitrary-Response Filter Design .....	2-37
<b>Special Topics in IIR Filter Design</b> .....	2-43
Classic IIR Filter Design .....	2-43
Analog Prototype Design .....	2-44
Frequency Transformation .....	2-44
Filter Discretization .....	2-46
<b>Filtering Data With Signal Processing Toolbox</b>	
<b>Software</b> .....	2-52
Lowpass FIR Filter — Window Method .....	2-52
Bandpass Filters — Minimum-Order FIR and IIR	
Systems .....	2-56
Zero-Phase Filtering .....	2-65
<b>Selected Bibliography</b> .....	2-71

## Designing a Filter in Fdesign — Process Overview

### 3

#### Process Flow Diagram and Filter Design

<b>Methodology</b> .....	3-2
Exploring the Process Flow Diagram .....	3-2
Selecting a Response .....	3-4
Selecting a Specification .....	3-4
Selecting an Algorithm .....	3-6
Customizing the Algorithm .....	3-8
Designing the Filter .....	3-8
Design Analysis .....	3-9
Realize or Apply the Filter to Input Data .....	3-10

## Designing a Filter in the Filterbuilder GUI

### 4

<b>Filterbuilder Design Process</b> .....	4-2
Introduction to Filterbuilder .....	4-2
Design a Filter Using Filterbuilder .....	4-2
Select a Response .....	4-3
Select a Specification .....	4-5
Select an Algorithm .....	4-5
Customize the Algorithm .....	4-6
Analyze the Design .....	4-8
Realize or Apply the Filter to Input Data .....	4-8
<b>Designing a FIR Filter Using filterbuilder</b> .....	4-10
FIR Filter Design .....	4-10

## FDATool: A Filter Design and Analysis GUI

### 5

<b>Overview</b> .....	5-2
-----------------------	-----

FDATool .....	5-2
Filter Design Methods .....	5-2
Using the Filter Design and Analysis Tool .....	5-4
Analyzing Filter Responses .....	5-4
Filter Design and Analysis Tool Panels .....	5-4
Getting Help .....	5-5
<b>Using FDATool .....</b>	<b>5-6</b>
Choosing a Response Type .....	5-7
Choosing a Filter Design Method .....	5-8
Setting the Filter Design Specifications .....	5-8
Computing the Filter Coefficients .....	5-12
Analyzing the Filter .....	5-13
Editing the Filter Using the Pole/Zero Editor .....	5-19
Converting the Filter Structure .....	5-23
Exporting a Filter Design .....	5-26
Generating a C Header File .....	5-32
Generating MATLAB Code .....	5-34
Managing Filters in the Current Session .....	5-35
Saving and Opening Filter Design Sessions .....	5-38
<b>Importing a Filter Design .....</b>	<b>5-39</b>
Import Filter Panel .....	5-39
Filter Structures .....	5-40

## Statistical Signal Processing

# 6

<b>Correlation and Covariance .....</b>	<b>6-2</b>
Background Information .....	6-2
Using xcorr and xcov Functions .....	6-3
Bias and Normalization .....	6-3
Multiple Channels .....	6-4
<b>Spectral Analysis .....</b>	<b>6-5</b>
Background Information .....	6-5
Spectral Estimation Method .....	6-7
Nonparametric Methods .....	6-9
Parametric Methods .....	6-32



## Special Topics

# 7

<b>Windows</b> .....	7-2
Why Use Windows? .....	7-2
Available Window Functions .....	7-2
Graphical User Interface Tools .....	7-3
Basic Shapes .....	7-3
Generalized Cosine Windows .....	7-6
Kaiser Window .....	7-8
Chebyshev Window .....	7-12
<b>Parametric Modeling</b> .....	7-13
What is Parametric Modeling .....	7-13
Available Parametric Modeling Functions .....	7-13
Time-Domain Based Modeling .....	7-14
Frequency-Domain Based Modeling .....	7-18
<b>Resampling</b> .....	7-21
Available Resampling Functions .....	7-21
resample Function .....	7-21
decimate and interp Functions .....	7-23
upfirdn Function .....	7-23
spline Function .....	7-23
<b>Cepstrum Analysis</b> .....	7-24
What Is a Cepstrum? .....	7-24
Inverse Complex Cepstrum .....	7-27
<b>FFT-Based Time-Frequency Analysis</b> .....	7-28
<b>Median Filtering</b> .....	7-29
<b>Communications Applications</b> .....	7-30
Modulation .....	7-30
Demodulation .....	7-31

Voltage Controlled Oscillator .....	7-34
<b>Deconvolution</b> .....	7-35
<b>Specialized Transforms</b> .....	7-36
Chirp z-Transform .....	7-36
Discrete Cosine Transform .....	7-37
Hilbert Transform .....	7-40
Walsh–Hadamard Transform .....	7-41
<b>Selected Bibliography</b> .....	7-47

## SPTool: A Signal Processing GUI Suite

# 8

<b>SPTool: An Interactive Signal Processing</b>	
<b>Environment</b> .....	8-2
SPTool Overview .....	8-2
SPTool Data Structures .....	8-3
<b>Opening SPTool</b> .....	8-4
<b>Getting Context-Sensitive Help</b> .....	8-6
<b>Signal Browser</b> .....	8-7
Overview of the Signal Browser .....	8-7
Opening the Signal Browser .....	8-7
<b>FDATool</b> .....	8-10
<b>Filter Visualization Tool</b> .....	8-11
Connection between FVTool and SPTool .....	8-11
Opening the Filter Visualization Tool .....	8-11
Analysis Parameters .....	8-12
<b>Spectrum Viewer</b> .....	8-13

Spectrum Viewer Overview .....	8-13
Opening the Spectrum Viewer .....	8-13
<b>Filtering and Analysis of Noise .....</b>	<b>8-16</b>
Overview .....	8-16
Importing a Signal into SPTool .....	8-16
Designing a Filter .....	8-18
Applying a Filter to a Signal .....	8-20
Analyzing a Signal .....	8-22
Spectral Analysis in the Spectrum Viewer .....	8-24
<b>Exporting Signals, Filters, and Spectra .....</b>	<b>8-27</b>
Opening the Export Dialog Box .....	8-27
Exporting a Filter to the MATLAB Workspace .....	8-28
<b>Accessing Filter Parameters .....</b>	<b>8-29</b>
Accessing Filter Parameters in a Saved Filter .....	8-29
Accessing Parameters in a Saved Spectrum .....	8-30
<b>Importing Filters and Spectra .....</b>	<b>8-32</b>
Similarities to Other Procedures .....	8-32
Importing Filters .....	8-32
Importing Spectra .....	8-34
<b>Loading Variables from the Disk .....</b>	<b>8-36</b>
<b>Saving and Loading Sessions .....</b>	<b>8-37</b>
SPTool Sessions .....	8-37
Filter Formats .....	8-37
<b>Selecting Signals, Filters, and Spectra .....</b>	<b>8-39</b>
<b>Editing Signals, Filters, or Spectra .....</b>	<b>8-40</b>
<b>Making Signal Measurements with Markers .....</b>	<b>8-41</b>
<b>Setting Preferences .....</b>	<b>8-43</b>
Overview of Setting Preferences .....	8-43
Summary of Settable Preferences .....	8-44

Setting the Filter Design Tool .....	8-45
<b>Using the Filter Designer .....</b>	<b>8-47</b>
Filter Designer .....	8-47
Filter Types .....	8-47
FIR Filter Methods .....	8-48
IIR Filter Methods .....	8-48
Pole/Zero Editor .....	8-48
Spectral Overlay Feature .....	8-48
Opening the Filter Designer .....	8-48
Accessing Filter Parameters in a Saved Filter .....	8-50
Designing a Filter with the Pole/Zero Editor .....	8-53
Positioning Poles and Zeros .....	8-54
Redesigning a Filter Using the Magnitude Plot .....	8-56

## Code Generation from MATLAB Support in Signal Processing Toolbox

# 9

<b>Supported Functions .....</b>	<b>9-2</b>
<b>Specifying Inputs in Code Generation from MATLAB</b> .....	<b>9-7</b>
Defining Input Size and Type .....	9-7
Inputs must be Constants .....	9-8
<b>Code Generation Examples .....</b>	<b>9-11</b>
Apply Window to Input Signal .....	9-11
Apply Lowpass Filter to Input Signal .....	9-13
Cross Correlate or Autocorrelate Input Data .....	9-14
freqz With No Output Arguments .....	9-15
Zero Phase Filtering .....	9-16

## Convolution and Correlation

---

### 10

Linear and Circular Convolution .....	10-2
Confidence Intervals for Sample Autocorrelation .....	10-5
Residual Analysis with Autocorrelation .....	10-9
Autocorrelation of Moving Average Process .....	10-19
Cross-correlation of Two Moving Average Processes ..	10-21
Cross-correlation of Delayed Signal in Noise .....	10-23
Cross-correlation of Phase-Lagged Sine Wave .....	10-26

## Multirate Signal Processing

---

### 11

Downsampling — Signal Phases .....	11-2
Downsampling — Aliasing .....	11-6
Filtering Before Downsampling .....	11-12
Upsampling — Imaging Artifacts .....	11-14
Filtering After Upsampling — Interpolation .....	11-16
Changing Signal Sampling Rate .....	11-18

## Spectral Analysis

---

### 12

Power Spectral Density Estimates Using FFT .....	12-2
Bias and Variability in the Periodogram .....	12-10
Cross Spectrum and Magnitude-Squared Coherence ..	12-20
Amplitude Estimation and Zero Padding .....	12-24
Significance Testing for Periodic Component .....	12-27
Frequency Estimation by Subspace Methods .....	12-29
Frequency-Domain Linear Regression .....	12-32

## Linear Prediction

---

### 13

Prediction Polynomial .....	13-2
Formant Estimation with LPC Coefficients .....	13-5
AR Order Selection with Partial Autocorrelation Sequence .....	13-9

## Transforms

---

### 14

Complex Cepstrum — Fundamental Frequency Estimation .....	14-2
--	------

<b>Analytic Signal for Cosine</b> .....	<b>14-6</b>
<b>Envelope Extraction Using The Analytic Signal</b> .....	<b>14-9</b>

## Signal Generation

# 15

<b>Display Time-Domain Data in Signal Browser</b> .....	<b>15-2</b>
Import and Display Signals .....	<b>15-3</b>
Configure the Signal Browser Properties .....	<b>15-6</b>
Modify the Signal Browser Display .....	<b>15-9</b>
Inspect Your Data (Scaling the Axes and Zooming) .....	<b>15-11</b>

## Signal Measurement

# 16

<b>RMS Value of Periodic Waveforms</b> .....	<b>16-2</b>
<b>Slew Rate of Triangular Waveform</b> .....	<b>16-5</b>
<b>Duty Cycle of Rectangular Pulse Waveform</b> .....	<b>16-9</b>
<b>Estimate State for Digital Clock</b> .....	<b>16-12</b>
<b>Calculate Settling Time with Signal Browser</b> .....	<b>16-16</b>
<b>Find Peak Amplitudes in Signal Browser</b> .....	<b>16-20</b>

**Technical Conventions**

**A**

**Index**



# Filtering, Linear Systems and Transforms Overview

---

- “Filter Implementation and Analysis” on page 1-2
- “The filter Function” on page 1-6
- “Other Functions for Filtering” on page 1-8
- “Impulse Response” on page 1-12
- “Frequency Response” on page 1-14
- “Zero-Pole Analysis” on page 1-21
- “Linear System Models” on page 1-23
- “Discrete Fourier Transform” on page 1-34

## Filter Implementation and Analysis

### In this section...

“Filtering Overview” on page 1-2

“Convolution and Filtering” on page 1-2

“Filters and Transfer Functions” on page 1-3

“Filtering with the filter Function” on page 1-4

### Filtering Overview

This section describes how to filter discrete signals using the MATLAB® `filter` function and other Signal Processing Toolbox™ functions. It also discusses how to use the toolbox functions to analyze filter characteristics, including impulse response, magnitude and phase response, group delay, and zero-pole locations.

### Convolution and Filtering

The mathematical foundation of filtering is convolution. The MATLAB `conv` function performs standard one-dimensional convolution, convolving one vector with another:

```
conv([1 1 1],[1 1 1])
ans =
     1     2     3     2     1
```

---

**Note** Convolve rectangular matrices for two-dimensional signal processing using the `conv2` function.

---

A digital filter’s output  $y(k)$  is related to its input  $x(k)$  by convolution with its impulse response  $h(k)$ .

$$y(k) = \sum_{l=-\infty}^{\infty} h(l)x(k-l)$$

If a digital filter's impulse response  $h(k)$  is finite in length, and the input  $x(k)$  is also of finite length, you can implement the filter using `conv`. Store  $x(k)$  in a vector `x`,  $h(k)$  in a vector `h`, and convolve the two:

```
x = randn(5,1);      % A random vector of length 5
h = [1 1 1 1]/4;    % Length 4 averaging filter
y = conv(h,x);
```

The length of the output is the sum of the finite-length input vectors minus 1.

## Filters and Transfer Functions

In general, the  $z$ -transform  $Y(z)$  of a discrete-time filter's output  $y(n)$  is related to the  $z$ -transform  $X(z)$  of the input by

$$Y(z) = H(z)X(z) = \frac{b(1) + b(2)z^{-1} + \dots + b(n+1)z^{-n}}{a(1) + a(2)z^{-1} + \dots + a(m+1)z^{-m}} X(z)$$

where  $H(z)$  is the filter's *transfer function*. Here, the constants  $b(i)$  and  $a(i)$  are the filter coefficients and the order of the filter is the maximum of  $n$  and  $m$ .

---

**Note** The filter coefficients start with subscript 1, rather than 0. This reflects the standard indexing scheme used for MATLAB vectors.

---

MATLAB filter functions store the coefficients in two vectors, one for the numerator and one for the denominator. By convention, it uses row vectors for filter coefficients.

## Filter Coefficients and Filter Names

Many standard names for filters reflect the number of `a` and `b` coefficients present:

- When  $n = 0$  (that is, `b` is a scalar), the filter is an Infinite Impulse Response (IIR), all-pole, recursive, or autoregressive (AR) filter.
- When  $m = 0$  (that is, `a` is a scalar), the filter is a Finite Impulse Response (FIR), all-zero, nonrecursive, or moving-average (MA) filter.

- If both  $n$  and  $m$  are greater than zero, the filter is an IIR, pole-zero, recursive, or autoregressive moving-average (ARMA) filter.

The acronyms AR, MA, and ARMA are usually applied to filters associated with filtered stochastic processes.

## Filtering with the filter Function

It is simple to work back to a difference equation from the  $z$ -transform relation shown earlier. Assume that  $a(1) = 1$ . Move the denominator to the left-hand side and take the inverse  $z$ -transform.

$$y(k) + a(2)y(k-1) + \dots + a(m+1)y(k-m) = b(1)x(k) + b(2)x(k-1) + \dots + b(n+1)x(k-n)$$

In terms of current and past inputs, and past outputs,  $y(k)$  is

$$y(k) = b(1)x(k) + b(2)x(k-1) + \dots + b(n+1)x(k-n) - a(2)y(k-1) - \dots - a(m+1)y(k-m)$$

This is the standard time-domain representation of a digital filter, computed starting with  $y(1)$  and assuming a causal system with zero initial conditions. This representation's progression is

$$\begin{aligned} y(1) &= b(1)x(1) \\ y(2) &= b(1)x(2) + b(2)x(1) - a(2)y(1) \\ y(3) &= b(1)x(3) + b(2)x(2) + b(3)x(1) - a(2)y(2) - a(3)y(1) \\ \vdots &= \vdots \end{aligned}$$

A filter in this form is easy to implement with the `filter` function. For example, a simple single-pole filter (lowpass) is

```
B = 1;           % Numerator
A = [1 -0.9];   % Denominator
```

where the vectors  $B$  and  $A$  represent the coefficients of a filter in transfer function form. Note that the  $A$  coefficient vectors are written as if the output and input terms are separated in the difference equation. For the example, the previous coefficient vectors represent a linear constant-coefficient difference equation of

$$y(n) - 0.9y(n-1) = x(n)$$

Changing the sign of the A(2) coefficient, results in the difference equation

$$y(n) + 0.9y(n-1) = x(n)$$

The previous coefficients are represented as:

```
B = 1; %Numerator  
A = [1 0.9]; %Denominator
```

and results in a highpass filter.

To apply this filter to your data, use

```
y = filter(B,A,x);
```

`filter` gives you as many output samples as there are input samples, that is, the length of `y` is the same as the length of `x`. If the first element of `a` is not 1, `filter` divides the coefficients by `a(1)` before implementing the difference equation.

## The filter Function

`filter` is implemented as the transposed direct-form II structure, where  $n-1$  is the filter order. This is a canonical form that has the minimum number of delay elements.

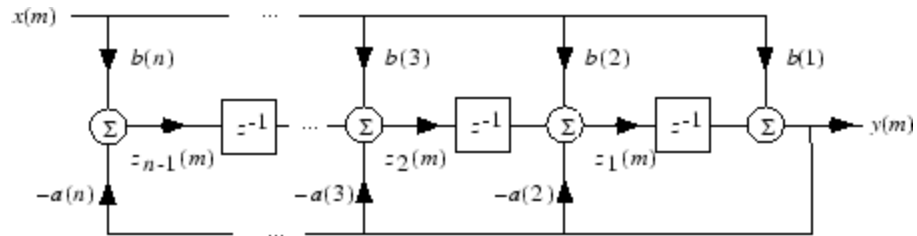

At sample  $m$ , `filter` computes the difference equations

$$\begin{aligned}
 y(m) &= b(1)x(m) + z_1(m-1) \\
 z_1(m) &= b(2)x(m) + z_2(m-1) - a(2)y(m) \\
 &\vdots \\
 z_{n-2}(m) &= b(n-1)x(m) + z_{n-1}(m-1) - a(n-1)y(m) \\
 z_{n-1}(m) &= b(n)x(m) - a(n)y(m)
 \end{aligned}$$

In its most basic form, `filter` initializes the delay outputs  $z_i(1)$ ,  $i = 1, \dots, n-1$  to 0. This is equivalent to assuming both past inputs and outputs are zero. Set the initial delay outputs using a fourth input parameter to `filter`, or access the final delay outputs using a second output parameter:

```
[y,zf] = filter(b,a,x,zi)
```

Access to initial and final conditions is useful for filtering data in sections, especially if memory limitations are a consideration. Suppose you have collected data in two segments of 5000 points each:

```
x1 = randn(5000,1); % Generate two random data sequences.
x2 = randn(5000,1);
```

Perhaps the first sequence, `x1`, corresponds to the first 10 minutes of data and the second, `x2`, to an additional 10 minutes. The whole sequence is

`x = [x1;x2]`. If there is not sufficient memory to hold the combined sequence, filter the subsequences `x1` and `x2` one at a time. To ensure continuity of the filtered sequences, use the final conditions from `x1` as initial conditions to filter `x2`:

```
[y1,zf] = filter(b,a,x1);  
y2 = filter(b,a,x2,zf);
```

The `filtic` function generates initial conditions for `filter`. `filtic` computes the delay vector to make the behavior of the filter reflect past inputs and outputs that you specify. To obtain the same output delay values `zf` as above using `filtic`, use

```
zf = filtic(b,a,flipud(y1),flipud(x1));
```

This can be useful when filtering short data sequences, as appropriate initial conditions help reduce transient startup effects.

## Other Functions for Filtering

### In this section...

“Multirate Filter Bank Implementation” on page 1-8

“Anti-Causal, Zero-Phase Filter Implementation” on page 1-9

“Frequency Domain Filter Implementation” on page 1-10

### Multirate Filter Bank Implementation

The `upfirdn` function alters the sampling rate of a signal by an integer ratio  $P/Q$ . It computes the result of a cascade of three systems that performs the following tasks:

- Upsampling (zero insertion) by integer factor  $p$
- Filtering by FIR filter  $h$
- Downsampling by integer factor  $q$

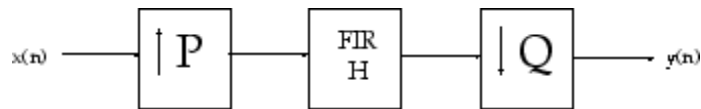

For example, to change the sample rate of a signal from 44.1 kHz to 48 kHz, we first find the smallest integer conversion ratio  $p/q$ . Set

```
d = gcd(48000,44100);
p = 48000/d;
q = 44100/d;
```

In this example,  $p = 160$  and  $q = 147$ . Sample rate conversion is then accomplished by typing

```
y = upfirdn(x,h,p,q)
```

This cascade of operations is implemented in an efficient manner using polyphase filtering techniques, and it is a central concept of multirate filtering. Note that the quality of the resampling result relies on the quality of the FIR filter  $h$ .



Filter banks may be implemented using `upfirdn` by allowing the filter `h` to be a matrix, with one FIR filter per column. A signal vector is passed independently through each FIR filter, resulting in a matrix of output signals.

Other functions that perform multirate filtering (with fixed filter) include `resample`, `interp`, and `decimate`.

## Anti-Causal, Zero-Phase Filter Implementation

In the case of FIR filters, it is possible to design linear phase filters that, when applied to data (using `filter` or `conv`), simply delay the output by a fixed number of samples. For IIR filters, however, the phase distortion is usually highly nonlinear. The `filtfilt` function uses the information in the signal at points before and after the current point, in essence “looking into the future,” to eliminate phase distortion.

To see how `filtfilt` does this, recall that if the  $z$ -transform of a real sequence  $x(n)$  is  $X(z)$ , the  $z$ -transform of the time reversed sequence  $x(n)$  is  $X(1/z)$ . Consider the processing scheme.

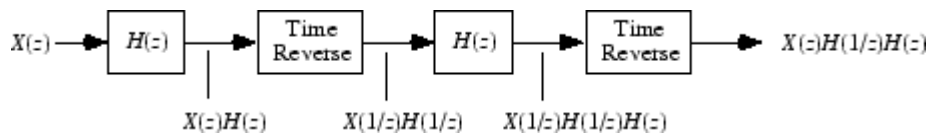

### Image of Anti Causal Zero Phase Filter

When  $|z| = 1$ , that is  $z = e^{j\omega}$ , the output reduces to  $X(e^{j\omega}) |H(e^{j\omega})|^2$ . Given all the samples of the sequence  $x(n)$ , a doubly filtered version of  $x$  that has zero-phase distortion is possible.

For example, a 1-second duration signal sampled at 100 Hz, composed of two sinusoidal components at 3 Hz and 40 Hz, is

```
fs = 100;
t = 0:1/fs:1;
x = sin(2*pi*t*3)+.25*sin(2*pi*t*40);
```

Now create a 10-point averaging FIR filter, and filter `x` using both `filter` and `filtfilt` for comparison:

```

b = ones(1,10)/10;           % 10 point averaging filter
y = filtfilt(b,1,x);         % Noncausal filtering
yy = filter(b,1,x);          % Normal filtering
plot(t,x,t,y,'--',t,yy,':')

```

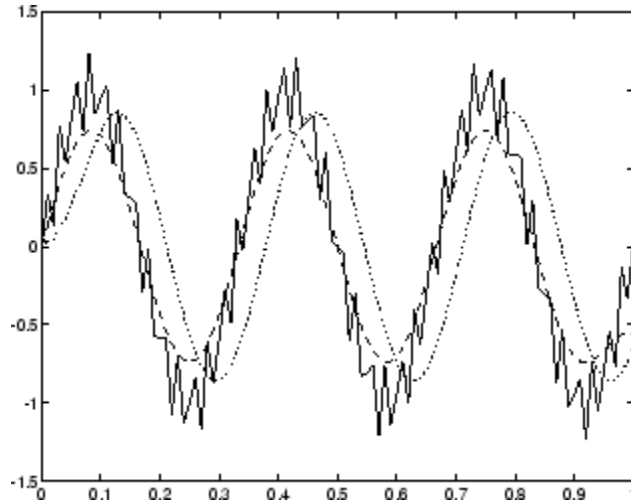

Both filtered versions eliminate the 40 Hz sinusoid evident in the original, solid line. The plot also shows how `filter` and `filtfilt` differ; the dashed (`filtfilt`) line is in phase with the original 3 Hz sinusoid, while the dotted (`filter`) line is delayed by about five samples. Also, the amplitude of the dashed line is smaller due to the magnitude squared effects of `filtfilt`.

`filtfilt` reduces filter startup transients by carefully choosing initial conditions, and by prepending onto the input sequence a short, reflected piece of the input sequence. For best results, make sure the sequence you are filtering has length at least three times the filter order and tapers to zero on both edges.

## Frequency Domain Filter Implementation

Duality between the time domain and the frequency domain makes it possible to perform any operation in either domain. Usually one domain or the other is more convenient for a particular operation, but you can always accomplish a given operation in either domain.

To implement general IIR filtering in the frequency domain, multiply the discrete Fourier transform (DFT) of the input sequence with the quotient of the DFT of the filter:

```
n = length(x);  
y = ifft(fft(x).*fft(b,n)./fft(a,n));
```

This computes results that are identical to `filter`, but with different startup transients (edge effects). For long sequences, this computation is very inefficient because of the large zero-padded FFT operations on the filter coefficients, and because the FFT algorithm becomes less efficient as the number of points `n` increases.

For FIR filters, however, it is possible to break longer sequences into shorter, computationally efficient FFT lengths. The function

```
y = fftfilt(b,x)
```

uses the overlap add method to filter a long sequence with multiple medium-length FFTs. Its output is equivalent to `filter(b,1,x)`.

## Impulse Response

The impulse response of a digital filter is the output arising from the unit impulse sequence defined as

$$\delta(n) = \begin{cases} 1 & n = 0 \\ 0 & n \neq 0 \end{cases}$$

You can generate an impulse sequence a number of ways; one straightforward way is

```
imp = [1; zeros(49,1)];
```

The impulse response of the simple filter  $b = 1$  and  $a = [1 \ -0.9]$  is

```
h = filter(b,a,imp);
```

A simple way to display the impulse response is with the Filter Visualization Tool (fvtool):

```
fvtool(b,a)
```

Then click the **Impulse Response** button  on the toolbar or select **Analysis > Impulse Response**. This plot shows the exponential decay  $h(n) = 0.9^n$  of the single pole system:

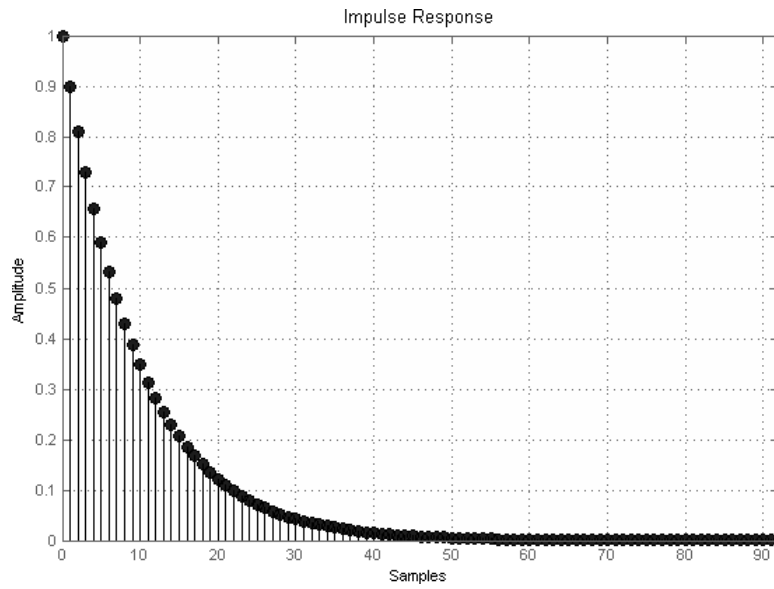

## Frequency Response

### In this section...

“Digital Domain” on page 1-14

“Analog Domain” on page 1-16

“Magnitude and Phase” on page 1-17

“Delay” on page 1-18

### Digital Domain

`freqz` uses an FFT-based algorithm to calculate the  $z$ -transform frequency response of a digital filter. Specifically, the statement

```
[h,w] = freqz(b,a,p)
```

returns the  $p$ -point complex frequency response,  $H(e^{j\omega})$ , of the digital filter.

$$H(e^{j\omega}) = \frac{b(1) + b(2)e^{-j\omega} + \dots + b(n+1)e^{-j\omega n}}{a(1) + a(2)e^{-j\omega} + \dots + a(m+1)e^{-j\omega m}}$$

In its simplest form, `freqz` accepts the filter coefficient vectors `b` and `a`, and an integer `p` specifying the number of points at which to calculate the frequency response. `freqz` returns the complex frequency response in vector `h`, and the actual frequency points in vector `w` in rad/s.

`freqz` can accept other parameters, such as a sampling frequency or a vector of arbitrary frequency points. The example below finds the 256-point frequency response for a 12th-order Chebyshev Type I filter. The call to `freqz` specifies a sampling frequency `fs` of 1000 Hz:

```
[b,a] = cheby1(12,0.5,200/500);
[h,f] = freqz(b,a,256,1000);
```

Because the parameter list includes a sampling frequency, `freqz` returns a vector `f` that contains the 256 frequency points between 0 and `fs/2` used in the frequency response calculation.

---

**Note** This toolbox uses the convention that unit frequency is the Nyquist frequency, defined as half the sampling frequency. The cutoff frequency parameter for all basic filter design functions is normalized by the Nyquist frequency. For a system with a 1000 Hz sampling frequency, for example, 300 Hz is  $300/500 = 0.6$ . To convert normalized frequency to angular frequency around the unit circle, multiply by  $\pi$ . To convert normalized frequency back to hertz, multiply by half the sample frequency.

---

If you call `freqz` with no output arguments, it plots both magnitude versus frequency and phase versus frequency. For example, a ninth-order Butterworth lowpass filter with a cutoff frequency of 400 Hz, based on a 2000 Hz sampling frequency, is

```
[b,a] = butter(9,400/1000);
```

To calculate the 256-point complex frequency response for this filter, and plot the magnitude and phase with `freqz`, use

```
freqz(b,a,256,2000)
```

or to display the magnitude and phase responses in `fvtool`, which provides additional analysis tools, use

```
fvtool(b,a)
```

and click the **Magnitude and Phase Response** button  on the toolbar or select **Analysis > Magnitude and Phase Response**.

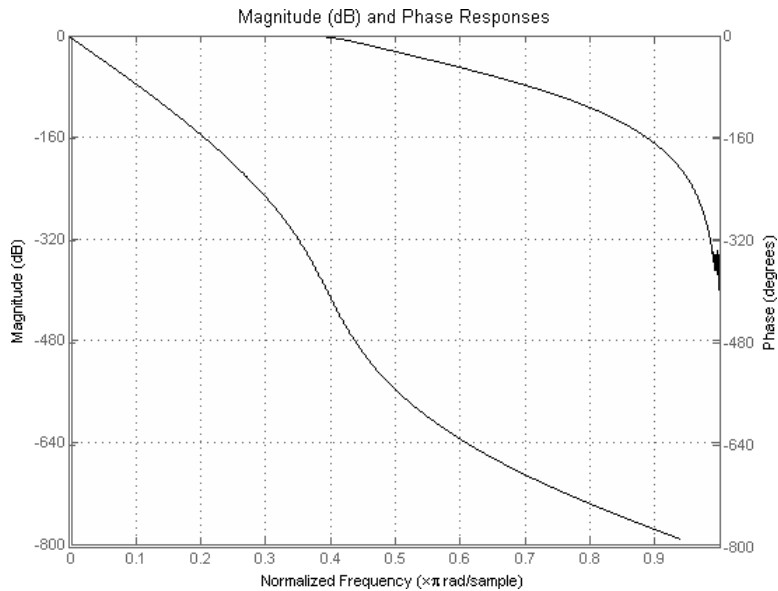

`freqz` can also accept a vector of arbitrary frequency points for use in the frequency response calculation. For example,

```
w = linspace(0,pi);
h = freqz(b,a,w);
```

calculates the complex frequency response at the frequency points in `w` for the filter defined by vectors `b` and `a`. The frequency points can range from 0 to  $2\pi$ . To specify a frequency vector that ranges from zero to your sampling frequency, include both the frequency vector and the sampling frequency value in the parameter list.

## Analog Domain

`freqs` evaluates frequency response for an analog filter defined by two input coefficient vectors, `b` and `a`. Its operation is similar to that of `freqz`; you can specify a number of frequency points to use, supply a vector of arbitrary frequency points, and plot the magnitude and phase response of the filter.



## Magnitude and Phase

MATLAB functions are available to extract magnitude and phase from a frequency response vector  $h$ . The function `abs` returns the magnitude of the response; `angle` returns the phase angle in radians. To extract the magnitude and phase of a Butterworth filter:

```
[b,a] = butter(9,400/1000);
fvtool(b,a)
```

and click the **Magnitude and Phase Response** button  on the toolbar or select **Analysis > Magnitude and Phase Response** to display the plot.

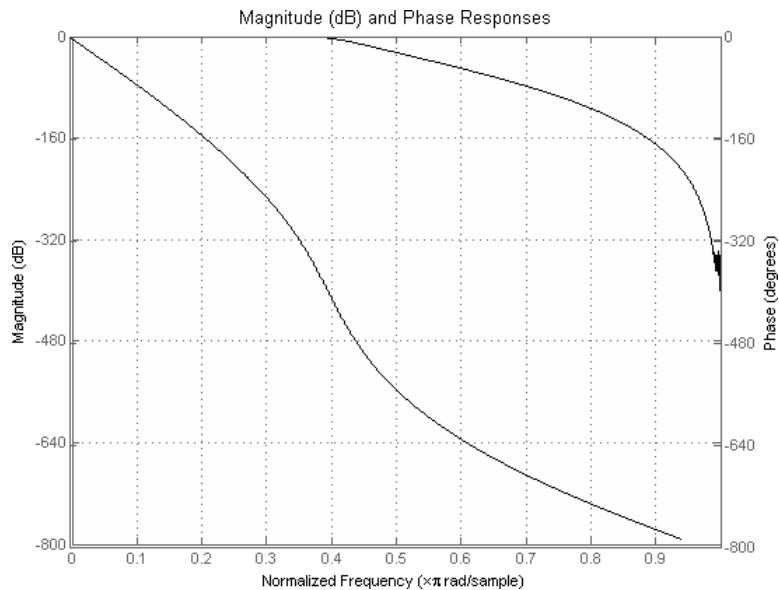

The `unwrap` function is also useful in frequency analysis. `unwrap` unwraps the phase to make it continuous across  $360^\circ$  phase discontinuities by adding multiples of  $\pm 360^\circ$ , as needed. To see how `unwrap` is useful, design a 25th-order lowpass FIR filter:

```
h = fir1(25,0.4);
```

Obtain the filter's frequency response with `freqz`, and plot the phase in degrees:

```
[H,f] = freqz(h,1,512,2);
plot(f,angle(H)*180/pi); grid
```

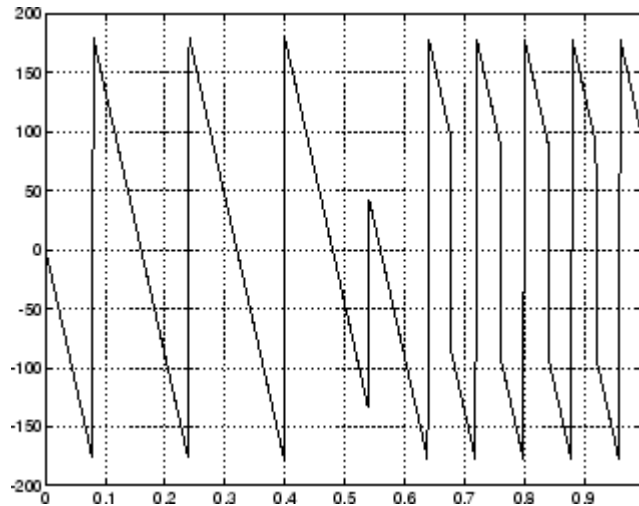

It is difficult to distinguish the 360° jumps (an artifact of the arctangent function inside angle) from the 180° jumps that signify zeros in the frequency response.

unwrap eliminates the 360° jumps:

```
plot(f,unwrap(angle(H))*180/pi);
```

or you can use phasez to see the unwrapped phase.

## Delay

The *group delay* of a filter is a measure of the average time delay of the filter as a function of frequency. It is defined as the negative first derivative of a filter's phase response. If the complex frequency response of a filter is  $H(e^{j\omega})$ , then the group delay is

$$\tau_g(\omega) = -\frac{d\theta(\omega)}{d\omega}$$

where  $\theta(\omega)$  is the phase, or argument of  $H(e^{j\omega})$ . Compute group delay with

```
[gd,w] = grpdelay(b,a,n)
```

which returns the n-point group delay,  $\tau_g(\omega)$  of the digital filter specified by **b** and **a**, evaluated at the frequencies in vector **w**.

The *phase delay* of a filter is the negative of phase divided by frequency:

$$\tau_p(\omega) = -\frac{\theta(\omega)}{\omega}$$

To plot both the group and phase delays of a system on the same FVTool graph, type

```
[b,a] = butter(10,200/1000);  
hFVT = fvtool(b,a,'Analysis','grpdelay');  
set(hFVT,'NumberOfPoints',128,'OverlaidAnalysis','phasedelay');  
legend(hFVT)
```

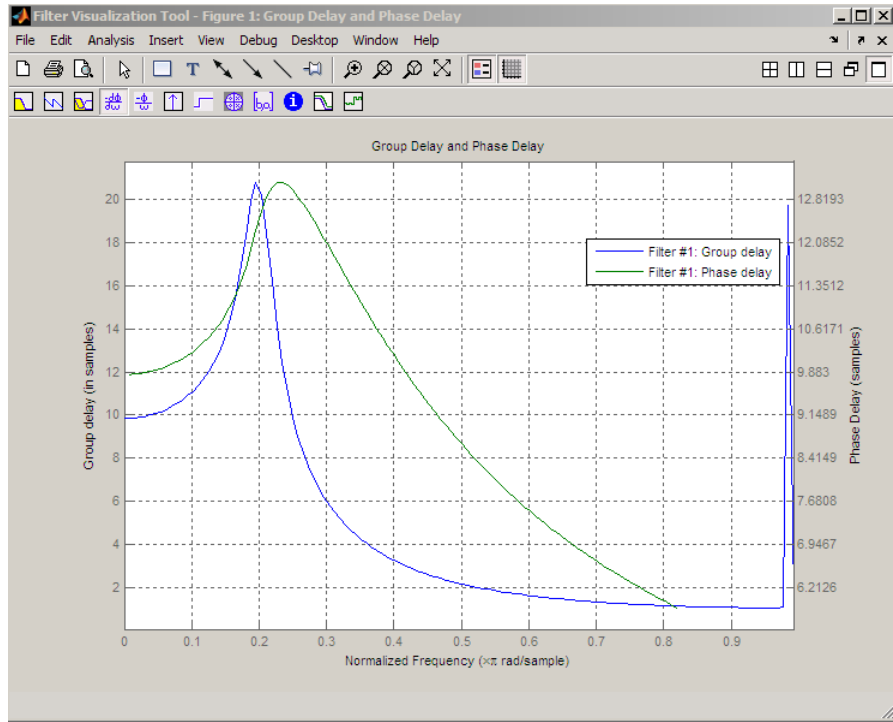

## Zero-Pole Analysis

The `zplane` function plots poles and zeros of a linear system. For example, a simple filter with a zero at  $-1/2$  and a complex pole pair at  $0.9e^{-j2\pi(0.3)}$  and  $0.9e^{j2\pi(0.3)}$  is

```
zer = -0.5;  
pol = 0.9*exp(j*2*pi*[-0.3 0.3]');
```

To view the pole-zero plot for this filter you can use

```
zplane(zer,pol)
```

or, for access to additional tools, use `fvtool`. First convert the poles and zeros to transfer function form, then call `fvtool`,

```
[b,a] = zp2tf(zer,pol,1);  
fvtool(b,a)
```

and click the **Pole/Zero Plot** toolbar button  on the toolbar or select **Analysis > Pole/Zero Plot** to see the plot.

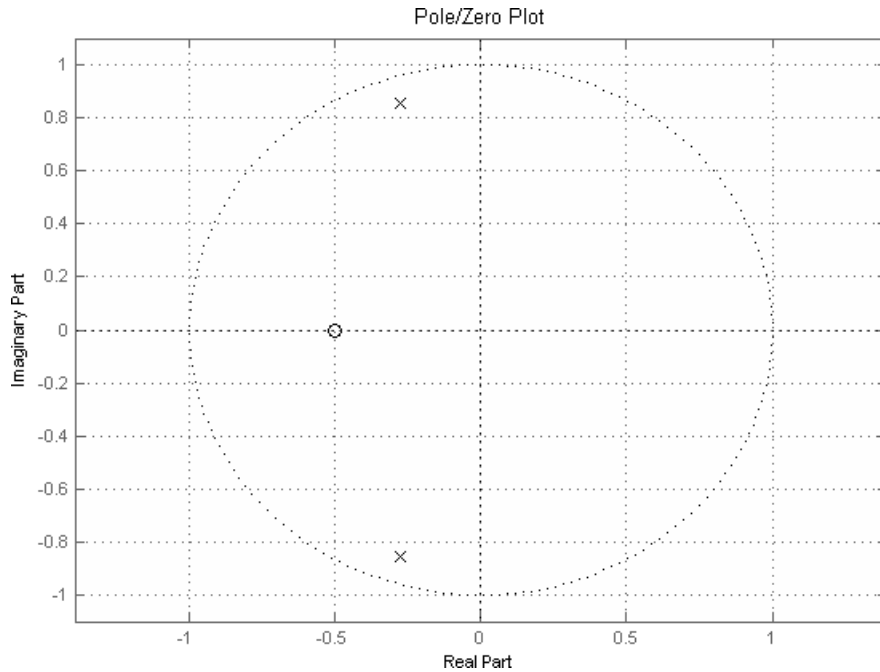

For a system in zero-pole form, supply column vector arguments  $z$  and  $p$  to `zplane`:

```
zplane(z,p)
```

For a system in transfer function form, supply row vectors  $b$  and  $a$  as arguments to `zplane`:

```
zplane(b,a)
```

In this case `zplane` finds the roots of  $b$  and  $a$  using the `roots` function and plots the resulting zeros and poles.

See “Linear System Models” on page 1-23 for details on zero-pole and transfer function representation of systems.

# Linear System Models

In this section...
“Available Models” on page 1-23
“Discrete-Time System Models” on page 1-23
“Continuous-Time System Models” on page 1-31
“Linear System Transformations” on page 1-32

## Available Models

Several Signal Processing Toolbox models are provided for representing linear time-invariant systems. This flexibility lets you choose the representational scheme that best suits your application and, within the bounds of numeric stability, convert freely to and from most other models. This section provides a brief overview of supported linear system models and describes how to work with these models in the MATLAB technical computing environment.

## Discrete-Time System Models

The discrete-time system models are representational schemes for digital filters. The MATLAB technical computing environment supports several discrete-time system models, which are described in the following sections:

- “Transfer Function” on page 1-23
- “Zero-Pole-Gain” on page 1-24
- “State-Space” on page 1-25
- “Partial Fraction Expansion (Residue Form)” on page 1-26
- “Second-Order Sections (SOS)” on page 1-27
- “Lattice Structure” on page 1-28
- “Convolution Matrix” on page 1-30

## Transfer Function

The *transfer function* is a basic  $z$ -domain representation of a digital filter, expressing the filter as a ratio of two polynomials. It is the principal

discrete-time model for this toolbox. The transfer function model description for the  $z$ -transform of a digital filter's difference equation is

$$Y(z) = \frac{b(1) + b(2)z^{-1} + \dots + b(n+1)z^{-n}}{a(1) + a(2)z^{-1} + \dots + a(m+1)z^{-m}} X(z)$$

Here, the constants  $b(i)$  and  $a(i)$  are the filter coefficients, and the order of the filter is the maximum of  $n$  and  $m$ . In the MATLAB environment, you store these coefficients in two vectors (row vectors by convention), one row vector for the numerator and one for the denominator. See “Filters and Transfer Functions” on page 1-3 for more details on the transfer function form.

### Zero-Pole-Gain

The factored or *zero-pole-gain* form of a transfer function is

$$H(z) = \frac{q(z)}{p(z)} = k \frac{(z - q(1))(z - q(2)) \dots (z - q(n))}{(z - p(1))(z - p(2)) \dots (z - p(n))}$$

By convention, polynomial coefficients are stored in row vectors and polynomial roots in column vectors. In zero-pole-gain form, therefore, the zero and pole locations for the numerator and denominator of a transfer function reside in column vectors. The factored transfer function gain  $k$  is a MATLAB scalar.

The `poly` and `roots` functions convert between polynomial and zero-pole-gain representations. For example, a simple IIR filter is

```
b = [2 3 4];  
a = [1 3 3 1];
```

The zeros and poles of this filter are

```
q = roots(b)  
p = roots(a)  
% Gain factor  
k = b(1)/a(1)
```

Returning to the original polynomials,



```
bb = k*poly(q)
aa = poly(p)
```

Note that **b** and **a** in this case represent the transfer function:

$$H(z) = \frac{2 + 3z^{-1} + 4z^{-2}}{1 + 3z^{-1} + 3z^{-2} + z^{-3}} = \frac{2z^2 + 3z + 4}{z^3 + 3z^2 + 3z + 1}$$

For **b** = [2 3 4], the `roots` function misses the zero for  $z$  equal to 0. In fact, it misses poles and zeros for  $z$  equal to 0 whenever the input transfer function has more poles than zeros, or vice versa. This is acceptable in most cases. To circumvent the problem, however, simply append zeros to make the vectors the same length before using the `roots` function; for example, **b** = [b 0].

## State-Space

It is always possible to represent a digital filter, or a system of difference equations, as a set of first-order difference equations. In matrix or *state-space* form, you can write the equations as

$$\begin{aligned}x(n+1) &= Ax(n) + Bu(n) \\y(n) &= Cx(n) + Du(n)\end{aligned}$$

where  $u$  is the input,  $x$  is the state vector, and  $y$  is the output. For single-channel systems, **A** is an  $m$ -by- $m$  matrix where  $m$  is the order of the filter, **B** is a column vector, **C** is a row vector, and **D** is a scalar. State-space notation is especially convenient for multichannel systems where input  $u$  and output  $y$  become vectors, and **B**, **C**, and **D** become matrices.

State-space representation extends easily to the MATLAB environment. **A**, **B**, **C**, and **D** are rectangular arrays; MATLAB functions treat them as individual variables.

Taking the  $z$ -transform of the state-space equations and combining them shows the equivalence of state-space and transfer function forms:

$$Y(z) = H(z)U(z), \text{ where } H(z) = C(zI - A)^{-1}B + D$$

Don't be concerned if you are not familiar with the state-space representation of linear systems. Some of the filter design algorithms use state-space form internally but do not require any knowledge of state-space concepts to use them successfully. If your applications use state-space based signal processing extensively, however, see the Control System Toolbox™ product for a comprehensive library of state-space tools.

### Partial Fraction Expansion (Residue Form)

Each transfer function also has a corresponding *partial fraction expansion* or *residue* form representation, given by

$$\frac{b(z)}{a(z)} = \frac{r(1)}{1 - p(1)z^{-1}} + \dots + \frac{r(n)}{1 - p(n)z^{-1}} + k(1) + k(2)z^{-1} + \dots + k(m - n + 1)z^{-(m-n)}$$

provided  $H(z)$  has no repeated poles. Here,  $n$  is the degree of the denominator polynomial of the rational transfer function  $b(z)/a(z)$ . If  $r$  is a pole of multiplicity  $s_r$ , then  $H(z)$  has terms of the form:

$$\frac{r(j)}{1 - p(j)z^{-1}} + \frac{r(j+1)}{(1 - p(j)z^{-1})^2} \dots + \frac{r(j + s_r - 1)}{(1 - p(j)z^{-1})^{s_r}}$$

The Signal Processing Toolbox `residuez` function inverts transfer functions to and from the partial fraction expansion form. The “z” on the end of `residuez` stands for z-domain, or discrete domain. `residuez` returns the poles in a column vector `p`, the residues corresponding to the poles in a column vector `r`, and any improper part of the original transfer function in a row vector `k`. `residuez` determines that two poles are the same if the magnitude of their difference is smaller than 0.1 percent of either of the poles' magnitudes.

Partial fraction expansion arises in signal processing as one method of finding the inverse z-transform of a transfer function. For example, the partial fraction expansion of

$$H(z) = \frac{-4 + 8z^{-1}}{1 + 6z^{-1} + 8z^{-2}}$$

is

```

b = [-4 8];
a = [1 6 8];
[r,p,k] = residuez(b,a)

```

which corresponds to

$$H(z) = \frac{-12}{1+4z^{-1}} + \frac{8}{1+2z^{-1}}$$

To find the inverse  $z$ -transform of  $H(z)$ , find the sum of the inverse  $z$ -transforms of the two addends of  $H(z)$ , giving the causal impulse response:

$$h(n) = -12(-4)^n + 8(-2)^n \quad n = 0, 1, 2, \dots$$

To verify this in the MATLAB environment, type

```

imp = [1 0 0 0 0];
resptf = filter(b,a,imp)
respres = filter(r(1),[1 -p(1)],imp)+...
         filter(r(2),[1 -p(2)],imp)

```

## Second-Order Sections (SOS)

Any transfer function  $H(z)$  has a second-order sections representation

$$H(z) = \prod_{k=1}^L H_k(z) = \prod_{k=1}^L \frac{b_{0k} + b_{1k}z^{-1} + b_{2k}z^{-2}}{a_{0k} + a_{1k}z^{-1} + a_{2k}z^{-2}}$$

where  $L$  is the number of second-order sections that describe the system. The MATLAB environment represents the second-order section form of a discrete-time system as an  $L$ -by-6 array `sos`. Each row of `sos` contains a single second-order section, where the row elements are the three numerator and three denominator coefficients that describe the second-order section.

$$sos = \begin{pmatrix} b_{01} & b_{11} & b_{21} & a_{01} & a_{11} & a_{21} \\ b_{02} & b_{12} & b_{22} & a_{02} & a_{12} & a_{22} \\ \cdot & \cdot & \cdot & \cdot & \cdot & \cdot \\ \cdot & \cdot & \cdot & \cdot & \cdot & \cdot \\ b_{0L} & b_{1L} & b_{2L} & a_{0L} & a_{1L} & a_{2L} \end{pmatrix}$$

There are many ways to represent a filter in second-order section form. Through careful pairing of the pole and zero pairs, ordering of the sections in the cascade, and multiplicative scaling of the sections, it is possible to reduce quantization noise gain and avoid overflow in some fixed-point filter implementations. The functions `zp2sos` and `ss2sos`, described in “Linear System Transformations” on page 1-32, perform pole-zero pairing, section scaling, and section ordering.

---

**Note** All Signal Processing Toolbox second-order section transformations apply only to digital filters.

---

### Lattice Structure

For a discrete  $N$ th order all-pole or all-zero filter described by the polynomial coefficients  $a(n)$ ,  $n = 1, 2, \dots, N+1$ , there are  $N$  corresponding lattice structure coefficients  $k(n)$ ,  $n = 1, 2, \dots, N$ . The parameters  $k(n)$  are also called the *reflection coefficients* of the filter. Given these reflection coefficients, you can implement a discrete filter as shown below.

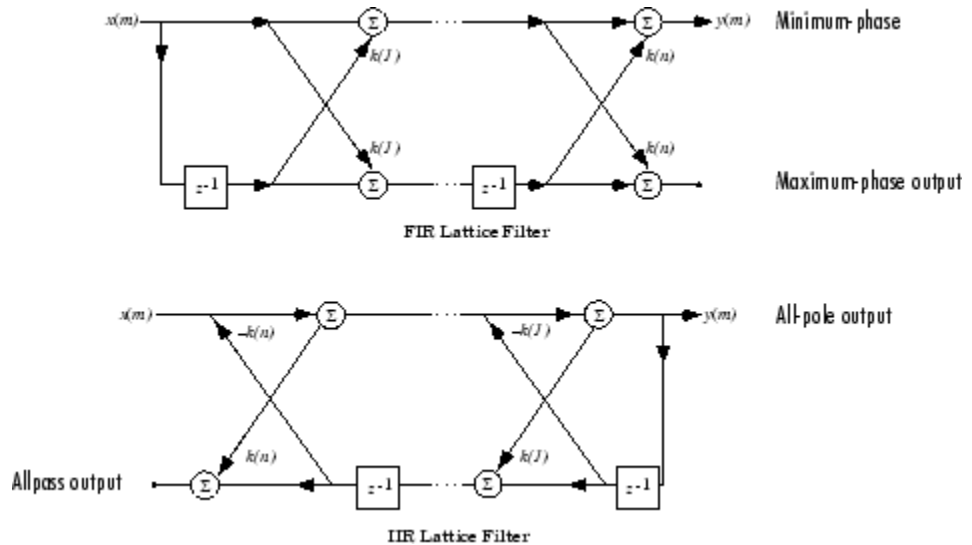

**FIR and IIR Lattice Filter structure diagrams**

For a general pole-zero IIR filter described by polynomial coefficients  $a$  and  $b$ , there are both lattice coefficients  $k(n)$  for the denominator  $a$  and ladder coefficients  $v(n)$  for the numerator  $b$ . The lattice/ladder filter may be implemented as

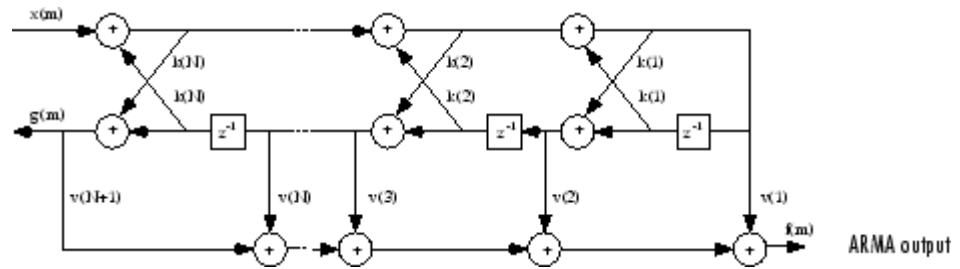

**Diagram of lattice/ladder filter**

The toolbox function `tf2latc` accepts an FIR or IIR filter in polynomial form and returns the corresponding reflection coefficients. An example FIR filter in polynomial form is

$$b = [1.0000 \quad 0.6149 \quad 0.9899 \quad 0.0000 \quad 0.0031 \quad -0.0082];$$

This filter's lattice (reflection coefficient) representation is

$$k = \text{tf2latc}(b)$$

For IIR filters, the magnitude of the reflection coefficients provides an easy stability check. If all the reflection coefficients corresponding to a polynomial have magnitude less than 1, all of that polynomial's roots are inside the unit circle. For example, consider an IIR filter with numerator polynomial  $b$  from above and denominator polynomial:

$$a = [1 \ 1/2 \ 1/3];$$

The filter's lattice representation is

$$[k,v] = \text{tf2latc}(b,a);$$

Because  $\text{abs}(k) < 1$  for all reflection coefficients in  $k$ , the filter is stable.

The function `latc2tf` calculates the polynomial coefficients for a filter from its lattice (reflection) coefficients. Given the reflection coefficient vector  $k$  (above), the corresponding polynomial form is

$$b = \text{latc2tf}(k);$$

The lattice or lattice/ladder coefficients can be used to implement the filter using the function `latcfilt`.

## Convolution Matrix

In signal processing, convolving two vectors or matrices is equivalent to filtering one of the input operands by the other. This relationship permits the representation of a digital filter as a *convolution matrix*.

Given any vector, the toolbox function `convmtx` generates a matrix whose inner product with another vector is equivalent to the convolution of the two vectors. The generated matrix represents a digital filter that you can apply to any vector of appropriate length; the inner dimension of the operands must agree to compute the inner product.

The convolution matrix for a vector  $b$ , representing the numerator coefficients for a digital filter, is

```
b = [1 2 3]; x = randn(3,1);
C = convmtx(b',3);
```

Two equivalent ways to convolve  $b$  with  $x$  are as follows.

```
y1 = C*x;
y2 = conv(b,x);
```

## Continuous-Time System Models

The continuous-time system models are representational schemes for analog filters. Many of the discrete-time system models described earlier are also appropriate for the representation of continuous-time systems:

- State-space form
- Partial fraction expansion
- Transfer function
- Zero-pole-gain form

It is possible to represent any system of linear time-invariant differential equations as a set of first-order differential equations. In matrix or *state-space* form, you can express the equations as

$$\begin{aligned} \dot{x} &= Ax + Bu \\ y &= Cx + Du \end{aligned}$$

where  $u$  is a vector of  $nu$  inputs,  $x$  is an  $nx$ -element state vector, and  $y$  is a vector of  $ny$  outputs. In the MATLAB environment,  $A$ ,  $B$ ,  $C$ , and  $D$  are stored in separate rectangular arrays.

An equivalent representation of the state-space system is the Laplace transform transfer function description

$$Y(s) = H(s)U(s)$$

where

$$H(s) = C(sI - A)^{-1}B + D$$

For single-input, single-output systems, this form is given by

$$H(s) = \frac{b(s)}{a(s)} = \frac{b(1)s^n + b(2)s^{n-1} + \dots + b(n+1)}{a(1)s^m + a(2)s^{m-1} + \dots + a(m+1)}$$

Given the coefficients of a Laplace transform transfer function, `residue` determines the partial fraction expansion of the system. See the description of `residue` for details.

The factored zero-pole-gain form is

$$H(s) = \frac{z(s)}{p(s)} = k \frac{(s - z(1))(s - z(2)) \dots (s - z(n))}{(s - p(1))(s - p(2)) \dots (s - p(m))}$$

As in the discrete-time case, the MATLAB environment stores polynomial coefficients in row vectors in descending powers of  $s$ . It stores polynomial roots, or zeros and poles, in column vectors.

## Linear System Transformations

A number of Signal Processing Toolbox functions are provided to convert between the various linear system models.. You can use the following chart to find an appropriate transfer function: find the row of the model to convert *from* on the left side of the chart and the column of the model to convert *to* on the top of the chart and read the function name(s) at the intersection of the row and column. Note that some cells of this table are empty.

	Transfer Function	State-Space	Zero-Pole-Gain	Partial Fraction	Lattice Filter	Second-Order Sections	Convolution Matrix
Transfer Function		tf2ss	tf2zp roots	residuez	tf2latc	none	convmtx
State-Space	ss2tf		ss2zp	none	none	ss2sos	none



	<b>Transfer Function</b>	<b>State-Space</b>	<b>Zero-Pole-Gain</b>	<b>Partial Fraction</b>	<b>Lattice Filter</b>	<b>Second-Order Sections</b>	<b>Convolution Matrix</b>
<b>Zero-Pole-Gain</b>	zp2tf poly	zp2ss		none	none	zp2sos	none
<b>Partial Fraction</b>	residuez	none	none		none	none	none
<b>Lattice Filter</b>	latc2tf	none	none	none		none	none
<b>SOS</b>	sos2tf	sos2ss	sos2zp	none	none		none

---

**Note** Converting from one filter structure or model to another may produce a result with different characteristics than the original. This is due to the computer's finite-precision arithmetic and the variations in the conversion's round-off computations.

---

Many of the toolbox filter design functions use these functions internally. For example, the zp2ss function converts the poles and zeros of an analog prototype into the state-space form required for creation of a Butterworth, Chebyshev, or elliptic filter. Once in state-space form, the filter design function performs any required frequency transformation, that is, it transforms the initial lowpass design into a bandpass, highpass, or bandstop filter, or a lowpass filter with the desired cutoff frequency.

---

**Note** All Signal Processing Toolbox second-order section transformations apply only to digital filters.

---

## Discrete Fourier Transform

The discrete Fourier transform, or DFT, is the primary tool of digital signal processing. The foundation of Signal Processing Toolbox product is the fast Fourier transform (FFT), a method for computing the DFT with reduced execution time. Many of the toolbox functions (including  $z$ -domain frequency response, spectrum and cepstrum analysis, and some filter design and implementation functions) incorporate the FFT.

The MATLAB environment provides the functions `fft` and `ifft` to compute the discrete Fourier transform and its inverse, respectively. For the input sequence  $x$  and its transformed version  $X$  (the discrete-time Fourier transform at equally spaced frequencies around the unit circle), the two functions implement the relationships

$$X(k+1) = \sum_{n=0}^{N-1} x(n+1)W_N^{kn},$$

and

$$x(n+1) = \frac{1}{N} \sum_{k=0}^{N-1} X(k+1)W_N^{-kn}.$$

In these equations, the series subscripts begin with 1 instead of 0 because of the MATLAB vector indexing scheme, and

$$W_N = e^{-j2\pi/N}.$$

---

**Note** The MATLAB convention is to use a negative  $j$  for the `fft` function. This is an engineering convention; physics and pure mathematics typically use a positive  $j$ .

---

`fft`, with a single input argument  $x$ , computes the DFT of the input vector or matrix. If  $x$  is a vector, `fft` computes the DFT of the vector; if  $x$  is a rectangular array, `fft` computes the DFT of each array column.

For example, create a time vector and signal:

```
t = (0:1/100:10-1/100);           % Time vector
x = sin(2*pi*15*t) + sin(2*pi*40*t); % Signal
```

The DFT of the signal, and the magnitude and phase of the transformed sequence, are then

```
y = fft(x);           % Compute DFT of x
m = abs(y); p = unwrap(angle(y)); % Magnitude and phase
```

To plot the magnitude and phase, type the following commands:

```
f = (0:length(y)-1)*99/length(y); % Frequency vector
plot(f,m); title('Magnitude');
set(gca,'XTick',[15 40 60 85]);
figure; plot(f,p*180/pi); title('Phase');
set(gca,'XTick',[15 40 60 85]);
```

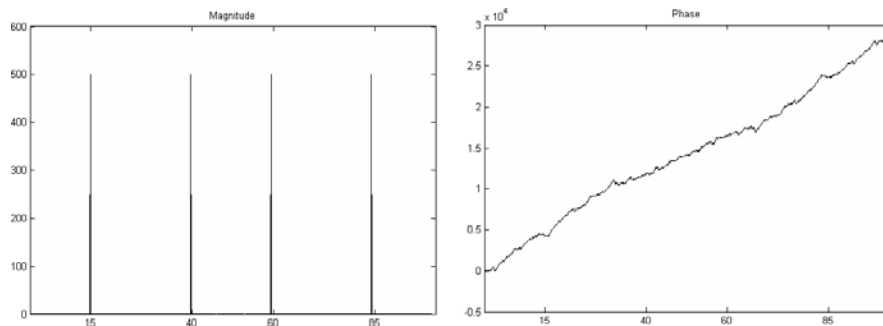

A second argument to `fft` specifies a number of points `n` for the transform, representing DFT length:

```
y = fft(x,n);
```

In this case, `fft` pads the input sequence with zeros if it is shorter than `n`, or truncates the sequence if it is longer than `n`. If `n` is not specified, it defaults to the length of the input sequence. Execution time for `fft` depends on the length, `n`, of the DFT it performs; see the `fft` for details about the algorithm.

---

**Note** The resulting FFT amplitude is  $A*n/2$ , where  $A$  is the original amplitude and  $n$  is the number of FFT points. This is true only if the number of FFT points is greater than or equal to the number of data samples. If the number of FFT points is less, the FFT amplitude is lower than the original amplitude by the above amount.

---

The inverse discrete Fourier transform function `ifft` also accepts an input sequence and, optionally, the number of desired points for the transform. Try the example below; the original sequence `x` and the reconstructed sequence are identical (within rounding error).

```
t = (0:1/255:1);  
x = sin(2*pi*120*t);  
y = real(ifft(fft(x)));
```

This toolbox also includes functions for the two-dimensional FFT and its inverse, `fft2` and `ifft2`. These functions are useful for two-dimensional signal or image processing. The `goertzel` function, which is another algorithm to compute the DFT, also is included in the toolbox. This function is efficient for computing the DFT of a portion of a long signal.

It is sometimes convenient to rearrange the output of the `fft` or `fft2` function so the zero frequency component is at the center of the sequence. The MATLAB function `fftshift` moves the zero frequency component to the center of a vector or matrix.

# Filter Design and Implementation

---

- “Filter Requirements and Specification” on page 2-2
- “IIR Filter Design” on page 2-4
- “FIR Filter Design” on page 2-17
- “Special Topics in IIR Filter Design” on page 2-43
- “Filtering Data With Signal Processing Toolbox Software” on page 2-52
- “Selected Bibliography” on page 2-71

## Filter Requirements and Specification

Filter design is the process of creating the filter coefficients to meet specific filtering requirements. Filter implementation involves choosing and applying a particular filter structure to those coefficients. Only after both design and implementation have been performed can data be filtered. The following chapter describes filter design and implementation in Signal Processing Toolbox software.

The goal of filter design is to perform frequency dependent alteration of a data sequence. A possible requirement might be to remove noise above 200 Hz from a data sequence sampled at 1000 Hz. A more rigorous specification might call for a specific amount of passband ripple, stopband attenuation, or transition width. A very precise specification could ask to achieve the performance goals with the minimum filter order, or it could call for an arbitrary magnitude shape, or it might require an FIR filter. Filter design methods differ primarily in how performance is specified.

To design a filter, the Signal Processing Toolbox software offers two approaches: object-oriented and non-object oriented. The object-oriented approach first constructs a filter specification object, `fdesign`, and then invokes an appropriate `design` method. To illustrate the object-oriented approach, design and implement a 5–th order lowpass Butterworth filter with a 3–dB frequency of 200 Hz. Assume a sampling frequency of 1 kHz. Apply the filter to input data.

```
Fs=1000; %Sampling Frequency
time = 0:(1/Fs):1; %time vector
% Data vector
x = cos(2*pi*60*time)+sin(2*pi*120*time)+randn(size(time));
d=fdesign.lowpass('N,F3dB',5,200,Fs); %lowpass filter specification object
% Invoke Butterworth design method
Hd=design(d,'butter');
y=filter(Hd,x);
```

The non-object oriented approach implements the filter using a function such as `butter` and `firpm`. All of the non-object oriented filter design functions operate with normalized frequencies. Convert frequency specifications in Hz to normalized frequency to use these functions. The Signal Processing Toolbox software defines normalized frequency to be in the closed interval

[0,1] with 1 denoting  $\pi$  radians/sample. For example, to specify a normalized frequency of  $\pi/2$  radians/sample, enter 0.5.

To convert from Hz to normalized frequency, multiply the frequency in Hz by two and divide by the sampling frequency. To design a 5–th order lowpass Butterworth filter with a 3–dB frequency of 200 Hz using the non-object oriented approach, use `butter`:

```
Wn = (2*200)/1000; %Convert 3-dB frequency  
% to normalized frequency: 0.4*pi rad/sample  
[B,A] = butter(5,Wn,'low');  
y = filter(B,A,x);
```

## IIR Filter Design

In this section...
“IIR vs. FIR Filters” on page 2-4
“Classical IIR Filters” on page 2-4
“Other IIR Filters” on page 2-5
“IIR Filter Method Summary” on page 2-5
“Classical IIR Filter Design Using Analog Prototyping” on page 2-6
“Comparison of Classical IIR Filter Types” on page 2-9

### IIR vs. FIR Filters

The primary advantage of IIR filters over FIR filters is that they typically meet a given set of specifications with a much lower filter order than a corresponding FIR filter. Although IIR filters have nonlinear phase, data processing within MATLAB software is commonly performed “offline,” that is, the entire data sequence is available prior to filtering. This allows for a noncausal, zero-phase filtering approach (via the `filtfilt` function), which eliminates the nonlinear phase distortion of an IIR filter.

### Classical IIR Filters

The classical IIR filters, Butterworth, Chebyshev Types I and II, elliptic, and Bessel, all approximate the ideal “brick wall” filter in different ways.

This toolbox provides functions to create all these types of classical IIR filters in both the analog and digital domains (except Bessel, for which only the analog case is supported), and in lowpass, highpass, bandpass, and bandstop configurations. For most filter types, you can also find the lowest filter order that fits a given filter specification in terms of passband and stopband attenuation, and transition width(s).



## Other IIR Filters

The direct filter design function `yulewalk` finds a filter with magnitude response approximating a desired function. This is one way to create a multiband bandpass filter.

You can also use the parametric modeling or system identification functions to design IIR filters. These functions are discussed in “Parametric Modeling” on page 7-13.

The generalized Butterworth design function `maxflat` is discussed in the section “Generalized Butterworth Filter Design” on page 2-15.

## IIR Filter Method Summary

The following table summarizes the various filter methods in the toolbox and lists the functions available to implement these methods.

### Toolbox Filters Methods and Available Functions

Filter Method	Description	Filter Functions
Analog Prototyping	Using the poles and zeros of a classical lowpass prototype filter in the continuous (Laplace) domain, obtain a digital filter through frequency transformation and filter discretization.	Complete design functions: <code>besself</code> , <code>butter</code> , <code>cheby1</code> , <code>cheby2</code> , <code>ellip</code> Order estimation functions: <code>buttord</code> , <code>cheb1ord</code> , <code>cheb2ord</code> , <code>ellipord</code> Lowpass analog prototype functions: <code>besselap</code> , <code>buttap</code> , <code>cheb1ap</code> , <code>cheb2ap</code> , <code>ellipap</code> Frequency transformation functions:  <code>lp2bp</code> , <code>lp2bs</code> , <code>lp2hp</code> , <code>lp2lp</code> Filter discretization functions:  <code>bilinear</code> , <code>impinvar</code>
Direct Design	Design digital filter directly in the discrete time-domain by approximating a piecewise linear magnitude response.	<code>yulewalk</code>

**Toolbox Filters Methods and Available Functions (Continued)**

<b>Filter Method</b>	<b>Description</b>	<b>Filter Functions</b>
Generalized Butterworth Design	Design lowpass Butterworth filters with more zeros than poles.	maxflat
Parametric Modeling	Find a digital filter that approximates a prescribed time or frequency domain response. (See System Identification Toolbox™ documentation for an extensive collection of parametric modeling tools.)	Time-domain modeling functions: lpc, prony, stmcb Frequency-domain modeling functions: invfreqs, invfreqz

**Classical IIR Filter Design Using Analog Prototyping**

The principal IIR digital filter design technique this toolbox provides is based on the conversion of classical lowpass analog filters to their digital equivalents. The following sections describe how to design filters and summarize the characteristics of the supported filter types. See “Special Topics in IIR Filter Design” on page 2-43 for detailed steps on the filter design process.

**Complete Classical IIR Filter Design**

You can easily create a filter of any order with a lowpass, highpass, bandpass, or bandstop configuration using the filter design functions.

**Filter Design Functions**

<b>Filter Type</b>	<b>Design Function</b>
Bessel (analog only)	[b,a] = besself(n,Wn,options) [z,p,k] = besself(n,Wn,options) [A,B,C,D] = besself(n,Wn,options)
Butterworth	[b,a] = butter(n,Wn,options) [z,p,k] = butter(n,Wn,options) [A,B,C,D] = butter(n,Wn,options)

**Filter Design Functions (Continued)**

<b>Filter Type</b>	<b>Design Function</b>
Chebyshev Type I	$[b, a] = \text{cheby1}(n, R_p, W_n, \text{options})$ $[z, p, k] = \text{cheby1}(n, R_p, W_n, \text{options})$ $[A, B, C, D] = \text{cheby1}(n, R_p, W_n, \text{options})$
Chebyshev Type II	$[b, a] = \text{cheby2}(n, R_s, W_n, \text{options})$ $[z, p, k] = \text{cheby2}(n, R_s, W_n, \text{options})$ $[A, B, C, D] = \text{cheby2}(n, R_s, W_n, \text{options})$
Elliptic	$[b, a] = \text{ellip}(n, R_p, R_s, W_n, \text{options})$ $[z, p, k] = \text{ellip}(n, R_p, R_s, W_n, \text{options})$ $[A, B, C, D] = \text{ellip}(n, R_p, R_s, W_n, \text{options})$

By default, each of these functions returns a lowpass filter; you need only specify the desired cutoff frequency  $W_n$  in normalized frequency (Nyquist frequency = 1 Hz). For a highpass filter, append the string 'high' to the function's parameter list. For a bandpass or bandstop filter, specify  $W_n$  as a two-element vector containing the passband edge frequencies, appending the string 'stop' for the bandstop configuration.

Here are some example digital filters:

```
[b,a] = butter(5,0.4);           % Lowpass Butterworth
[b,a] = cheby1(4,1,[0.4 0.7]);  % Bandpass Chebyshev Type I
[b,a] = cheby2(6,60,0.8,'high'); % Highpass Chebyshev Type II
[b,a] = ellip(3,1,60,[0.4 0.7],'stop'); % Bandstop elliptic
```

To design an analog filter, perhaps for simulation, use a trailing 's' and specify cutoff frequencies in rad/s:

```
[b,a] = butter(5,.4,'s');      % Analog Butterworth filter
```

All filter design functions return a filter in the transfer function, zero-pole-gain, or state-space linear system model representation, depending on how many output arguments are present. In general, you should avoid

using the transfer function form because numerical problems caused by roundoff errors can occur. Instead, use the zero-pole-gain form which you can convert to a second-order section (SOS) form using `zp2sos` and then use the SOS form with `dfilt` to analyze or implement your filter.

---

**Note** All classical IIR lowpass filters are ill-conditioned for extremely low cutoff frequencies. Therefore, instead of designing a lowpass IIR filter with a very narrow passband, it can be better to design a wider passband and decimate the input signal.

---

### Designing IIR Filters to Frequency Domain Specifications

This toolbox provides order selection functions that calculate the minimum filter order that meets a given set of requirements.

Filter Type	Order Estimation Function
Butterworth	<code>[n,Wn] = buttord(Wp,Ws,Rp,Rs)</code>
Chebyshev Type I	<code>[n,Wn] = cheb1ord(Wp, Ws, Rp, Rs)</code>
Chebyshev Type II	<code>[n,Wn] = cheb2ord(Wp, Ws, Rp, Rs)</code>
Elliptic	<code>[n,Wn] = ellipord(Wp, Ws, Rp, Rs)</code>

These are useful in conjunction with the filter design functions. Suppose you want a bandpass filter with a passband from 1000 to 2000 Hz, stopbands starting 500 Hz away on either side, a 10 kHz sampling frequency, at most 1 dB of passband ripple, and at least 60 dB of stopband attenuation. You can meet these specifications by using the `butter` function as follows.

```
[n,Wn] = buttord([1000 2000]/5000,[500 2500]/5000,1,60)
n =
    12
Wn =
    0.1951    0.4080
[b,a] = butter(n,Wn);
```

An elliptic filter that meets the same requirements is given by

```

[n,Wn] = ellipord([1000 2000]/5000,[500 2500]/5000,1,60)
n =
    5
Wn =
    0.2000    0.4000
[b,a] = ellip(n,1,60,Wn);

```

These functions also work with the other standard band configurations, as well as for analog filters.

## Comparison of Classical IIR Filter Types

The toolbox provides five different types of classical IIR filters, each optimal in some way. This section shows the basic analog prototype form for each and summarizes major characteristics.

### Butterworth Filter

The Butterworth filter provides the best Taylor Series approximation to the ideal lowpass filter response at analog frequencies  $\Omega = 0$  and  $\Omega = \infty$ ; for any order  $N$ , the magnitude squared response has  $2N-1$  zero derivatives at these locations (*maximally flat* at  $\Omega = 0$  and  $\Omega = \infty$ ). Response is monotonic overall, decreasing smoothly from  $\Omega = 0$  to  $\Omega = \infty$ .  $|H(j\Omega)| = \sqrt{1/2}$  at  $\Omega = 1$ .

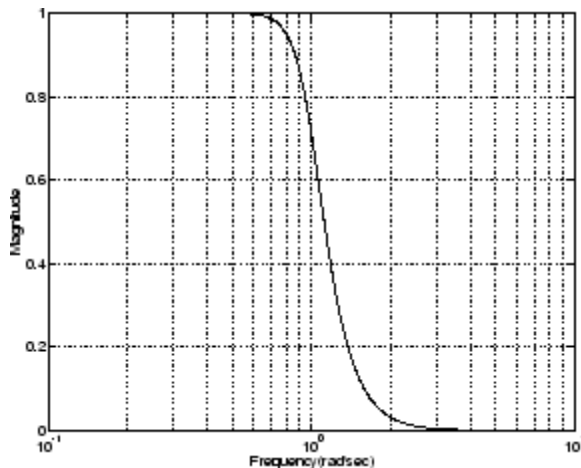

### Chebyshev Type I Filter

The Chebyshev Type I filter minimizes the absolute difference between the ideal and actual frequency response over the entire passband by incorporating an equal ripple of  $R_p$  dB in the passband. Stopband response is maximally flat. The transition from passband to stopband is more rapid than for the

Butterworth filter.  $|H(j\Omega)| = 10^{-R_p/20}$  at  $\Omega = 1$ .

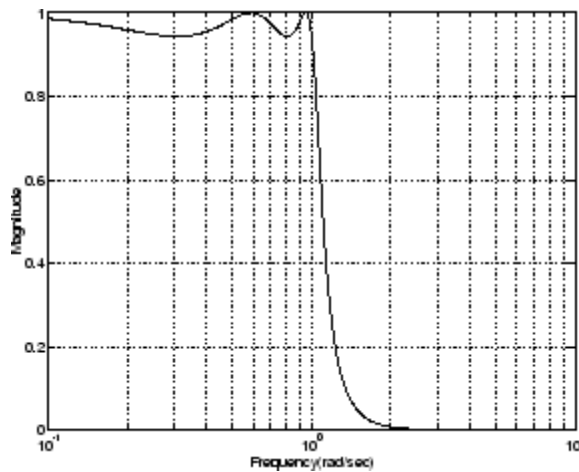

### Chebyshev Type II Filter

The Chebyshev Type II filter minimizes the absolute difference between the ideal and actual frequency response over the entire stopband by incorporating an equal ripple of  $R_s$  dB in the stopband. Passband response is maximally flat.

The stopband does not approach zero as quickly as the type I filter (and does not approach zero at all for even-valued filter order  $n$ ). The absence of ripple in the passband, however, is often an important advantage.

$|H(j\Omega)| = 10^{-R_s/20}$  at  $\Omega = 1$ .

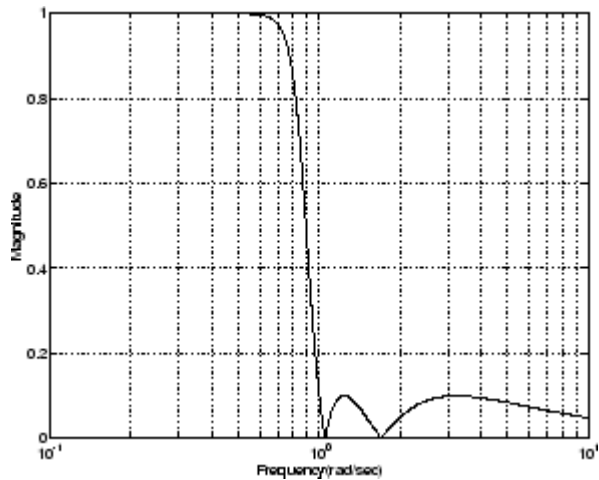

### Elliptic Filter

Elliptic filters are equiripple in both the passband and stopband. They generally meet filter requirements with the lowest order of any supported filter type. Given a filter order  $n$ , passband ripple  $R_p$  in decibels, and stopband ripple  $R_s$  in decibels, elliptic filters minimize transition width.

$$|H(j\Omega)| = 10^{-R_p/20} \text{ at } \Omega = 1.$$

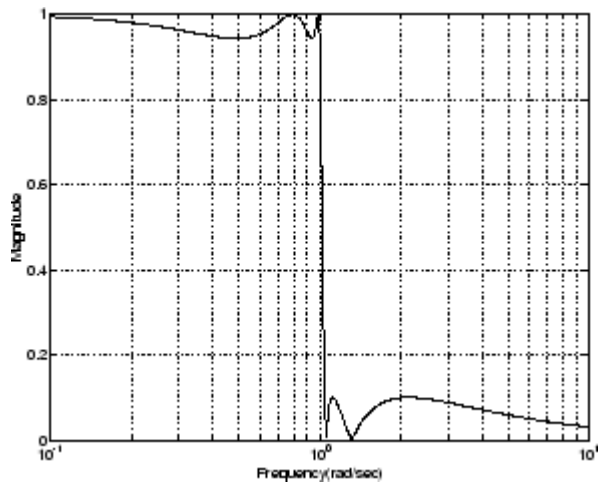

### Bessel Filter

Analog Bessel lowpass filters have maximally flat group delay at zero frequency and retain nearly constant group delay across the entire passband. Filtered signals therefore maintain their waveshapes in the passband frequency range. Frequency mapped and digital Bessel filters, however, do not have this maximally flat property; this toolbox supports only the analog case for the complete Bessel filter design function.

Bessel filters generally require a higher filter order than other filters for satisfactory stopband attenuation.  $|H(j\Omega)| < 1/\sqrt{2}$  at  $\Omega = 1$  and decreases as filter order  $n$  increases.

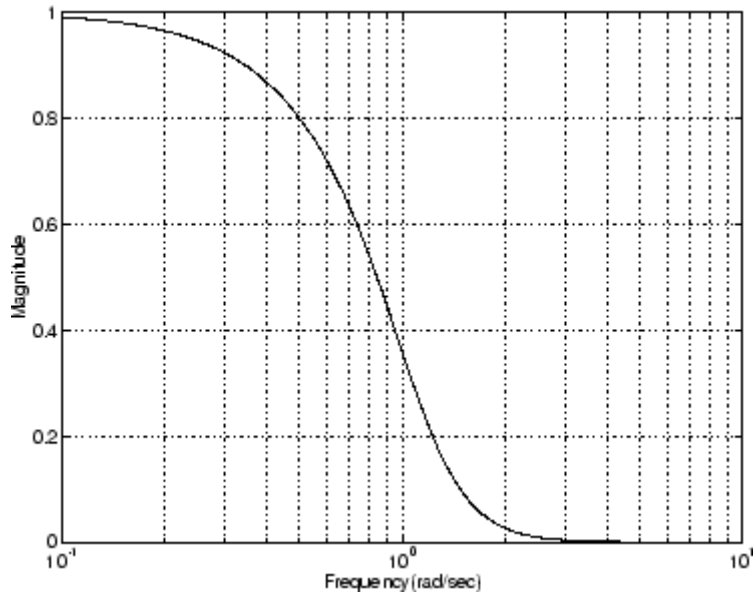



---

**Note** The lowpass filters shown above were created with the analog prototype functions `besselap`, `buttap`, `cheb1ap`, `cheb2ap`, and `ellipap`. These functions find the zeros, poles, and gain of an order  $n$  analog filter of the appropriate type with cutoff frequency of 1 rad/s. The complete filter design functions (`besself`, `butter`, `cheby1`, `cheby2`, and `ellip`) call the prototyping functions as a first step in the design process. See “Special Topics in IIR Filter Design” on page 2-43 for details.

---

To create similar plots, use  $n = 5$  and, as needed,  $R_p = 0.5$  and  $R_s = 20$ . For example, to create the elliptic filter plot:

```
[z,p,k] = ellipap(5,0.5,20);
w = logspace(-1,1,1000);
h = freqs(k*poly(z),poly(p),w);
semilogx(w,abs(h)), grid
```

## Direct IIR Filter Design

This toolbox uses the term *direct methods* to describe techniques for IIR design that find a filter based on specifications in the discrete domain. Unlike the analog prototyping method, direct design methods are not constrained to the standard lowpass, highpass, bandpass, or bandstop configurations. Rather, these functions design filters with an arbitrary, perhaps multiband, frequency response. This section discusses the `yulewalk` function, which is intended specifically for filter design; “Parametric Modeling” on page 7-13 discusses other methods that may also be considered direct, such as Prony’s method, Linear Prediction, the Steiglitz-McBride method, and inverse frequency design.

The `yulewalk` function designs recursive IIR digital filters by fitting a specified frequency response. `yulewalk`’s name reflects its method for finding the filter’s denominator coefficients: it finds the inverse FFT of the ideal desired magnitude-squared response and solves the modified Yule-Walker equations using the resulting autocorrelation function samples. The statement

```
[b,a] = yulewalk(n,f,m)
```

returns row vectors `b` and `a` containing the  $n+1$  numerator and denominator coefficients of the order  $n$  IIR filter whose frequency-magnitude characteristics approximate those given in vectors `f` and `m`. `f` is a vector of frequency points ranging from 0 to 1, where 1 represents the Nyquist frequency. `m` is a vector containing the desired magnitude response at the points in `f`. `f` and `m` can describe any piecewise linear shape magnitude response, including a multiband response. The FIR counterpart of this function is `fir2`, which also designs a filter based on an arbitrary piecewise linear magnitude response. See “FIR Filter Design” on page 2-17 for details.

Note that `yulewalk` does not accept phase information, and no statements are made about the optimality of the resulting filter.

Design a multiband filter with `yulewalk`, and plot the desired and actual frequency response:

```
m = [0 0 1 1 0 0 1 1 0 0];  
f = [0 0.1 0.2 0.3 0.4 0.5 0.6 0.7 0.8 1];  
[b,a] = yulewalk(10,f,m);  
[h,w] = freqz(b,a,128)  
plot(f,m,w/pi,abs(h))
```

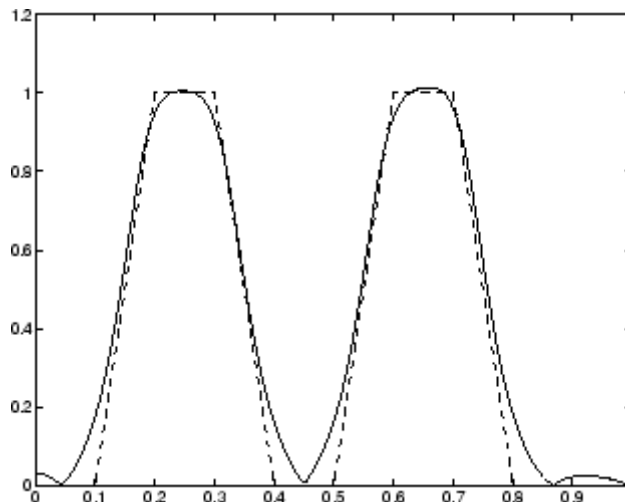

## Generalized Butterworth Filter Design

The toolbox function `maxflat` enables you to design generalized Butterworth filters, that is, Butterworth filters with differing numbers of zeros and poles. This is desirable in some implementations where poles are more expensive computationally than zeros. `maxflat` is just like the `butter` function, except that it you can specify *two* orders (one for the numerator and one for the denominator) instead of just one. These filters are *maximally flat*. This means that the resulting filter is optimal for any numerator and denominator orders, with the maximum number of derivatives at 0 and the Nyquist frequency  $\omega = \pi$  both set to 0.

For example, when the two orders are the same, `maxflat` is the same as `butter`:

```
[b,a] = maxflat(3,3,0.25)
b =
    0.0317    0.0951    0.0951    0.0317
a =
    1.0000   -1.4590    0.9104   -0.1978
[b,a] = butter(3,0.25)
b =
    0.0317    0.0951    0.0951    0.0317
a =
    1.0000   -1.4590    0.9104   -0.1978
```

However, `maxflat` is more versatile because it allows you to design a filter with more zeros than poles:

```
[b,a] = maxflat(3,1,0.25)
b =
    0.0950    0.2849    0.2849    0.0950
a =
    1.0000   -0.2402
```

The third input to `maxflat` is the *half-power frequency*, a frequency between 0 and 1 with a desired magnitude response of  $1/\sqrt{2}$ .

You can also design linear phase filters that have the maximally flat property using the `'sym'` option:

```
maxflat(4, 'sym', 0.3)
ans =
    0.0331    0.2500    0.4337    0.2500    0.0331
```

For complete details of the `maxflat` algorithm, see Selesnick and Burrus [2].

## FIR Filter Design

### In this section...

“FIR vs. IIR Filters” on page 2-17

“FIR Filter Summary” on page 2-18

“Linear Phase Filters” on page 2-18

“Windowing Method” on page 2-20

“Multiband FIR Filter Design with Transition Bands” on page 2-24

“Constrained Least Squares FIR Filter Design” on page 2-31

“Arbitrary-Response Filter Design” on page 2-37

### FIR vs. IIR Filters

Digital filters with finite-duration impulse response (all-zero, or FIR filters) have both advantages and disadvantages compared to infinite-duration impulse response (IIR) filters.

FIR filters have the following primary advantages:

- They can have exactly linear phase.
- They are always stable.
- The design methods are generally linear.
- They can be realized efficiently in hardware.
- The filter startup transients have finite duration.

The primary disadvantage of FIR filters is that they often require a much higher filter order than IIR filters to achieve a given level of performance. Correspondingly, the delay of these filters is often much greater than for an equal performance IIR filter.

## FIR Filter Summary

### FIR Filters

Filter Design Method	Description	Filter Functions
Windowing	Apply window to truncated inverse Fourier transform of desired “brick wall” filter	<code>fir1</code> , <code>fir2</code> , <code>kaiserord</code>
Multiband with Transition Bands	Equiripple or least squares approach over sub-bands of the frequency range	<code>firls</code> , <code>firpm</code> , <code>firpmord</code>
Constrained Least Squares	Minimize squared integral error over entire frequency range subject to maximum error constraints	<code>fircls</code> , <code>fircls1</code>
Arbitrary Response	Arbitrary responses, including nonlinear phase and complex filters	<code>cfirpm</code>
Raised Cosine	Lowpass response with smooth, sinusoidal transition	<code>firrcos</code>

### Linear Phase Filters

Except for `cfirpm`, all of the FIR filter design functions design linear phase filters only. The filter coefficients, or “taps,” of such filters obey either an even or odd symmetry relation. Depending on this symmetry, and on whether the order  $n$  of the filter is even or odd, a linear phase filter (stored in length  $n+1$  vector  $b$ ) has certain inherent restrictions on its frequency response.

Linear Phase Filter Type	Filter Order	Symmetry of Coefficients	Response $H(f)$ , $f = 0$	Response $H(f)$ , $f = 1$ (Nyquist)
Type I	Even	even: $b(k) = b(n+2-k)$ , $k = 1, \dots, n+1$	No restriction	No restriction
Type II	Odd	even: $b(k) = b(n+2-k)$ , $k = 1, \dots, n+1$	No restriction	$H(1) = 0$
Type III	Even	odd: $b(k) = -b(n+2-k)$ , $k = 1, \dots, n+1$	$H(0) = 0$	$H(1) = 0$
Type IV	Odd	odd: $b(k) = -b(n+2-k)$ , $k = 1, \dots, n+1$	$H(0) = 0$	No restriction

The phase delay and group delay of linear phase FIR filters are equal and constant over the frequency band. For an order  $n$  linear phase FIR filter, the group delay is  $n/2$ , and the filtered signal is simply delayed by  $n/2$  time steps (and the magnitude of its Fourier transform is scaled by the filter's magnitude response). This property preserves the wave shape of signals in the passband; that is, there is no phase distortion.

The functions `fir1`, `fir2`, `firls`, `firpm`, `fircls`, `fircls1`, and `firrcos` all design type I and II linear phase FIR filters by default. Both `firls` and `firpm` design type III and IV linear phase FIR filters given a 'hilbert' or 'differentiator' flag. `cfirpm` can design any type of linear phase filter, and nonlinear phase filters as well.

---

**Note** Because the frequency response of a type II filter is zero at the Nyquist frequency ("high" frequency), `fir1` does not design type II highpass and bandstop filters. For odd-valued  $n$  in these cases, `fir1` adds 1 to the order and returns a type I filter.

---

## Windowing Method

Consider the ideal, or “brick wall,” digital lowpass filter with a cutoff frequency of  $\omega_0$  rad/s. This filter has magnitude 1 at all frequencies with magnitude less than  $\omega_0$ , and magnitude 0 at frequencies with magnitude between  $\omega_0$  and  $\pi$ . Its impulse response sequence  $h(n)$  is

$$h(n) = \frac{1}{2\pi} \int_{-\pi}^{\pi} H(\omega) e^{j\omega n} d\omega = \frac{1}{2\pi} \int_{-\omega_0}^{\omega_0} e^{j\omega n} d\omega = \frac{\sin(\omega_0 n)}{\pi n}$$

This filter is not implementable since its impulse response is infinite and noncausal. To create a finite-duration impulse response, truncate it by applying a window. By retaining the central section of impulse response in this truncation, you obtain a linear phase FIR filter. For example, a length 51 filter with a lowpass cutoff frequency  $\omega_0$  of  $0.4 \pi$  rad/s is

```
b = 0.4*sinc(0.4*(-25:25));
```

The window applied here is a simple rectangular window. By Parseval’s theorem, this is the length 51 filter that best approximates the ideal lowpass filter, in the integrated least squares sense. The following command displays the filter’s frequency response in FVTool:

```
fvtool(b,1)
```



Note that the y-axis shown in the figure below is in Magnitude Squared. You can set this by right-clicking on the axis label and selecting **Magnitude Squared** from the menu.

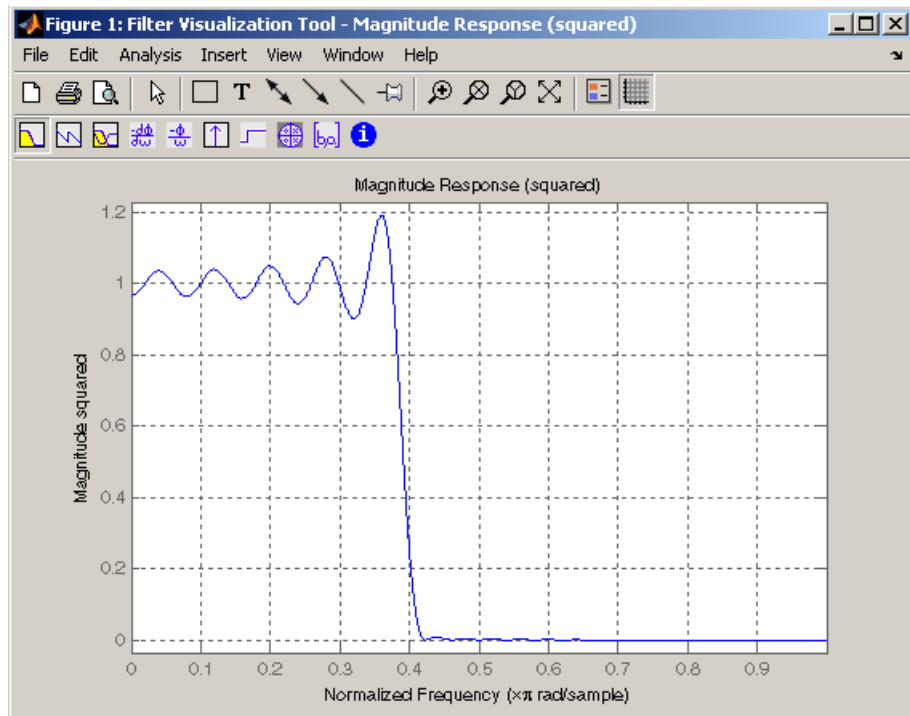

Ringings and ripples occur in the response, especially near the band edge. This “Gibbs effect” does not vanish as the filter length increases, but a nonrectangular window reduces its magnitude. Multiplication by a window in the time domain causes a convolution or smoothing in the frequency domain. Apply a length 51 Hamming window to the filter and display the result using FVTool:

```
b = 0.4*sinc(0.4*(-25:25));
b = b.*hamming(51)';
fvtool(b,1)
```

Note that the y-axis shown in the figure below is in Magnitude Squared. You can set this by right-clicking on the axis label and selecting **Magnitude Squared** from the menu.

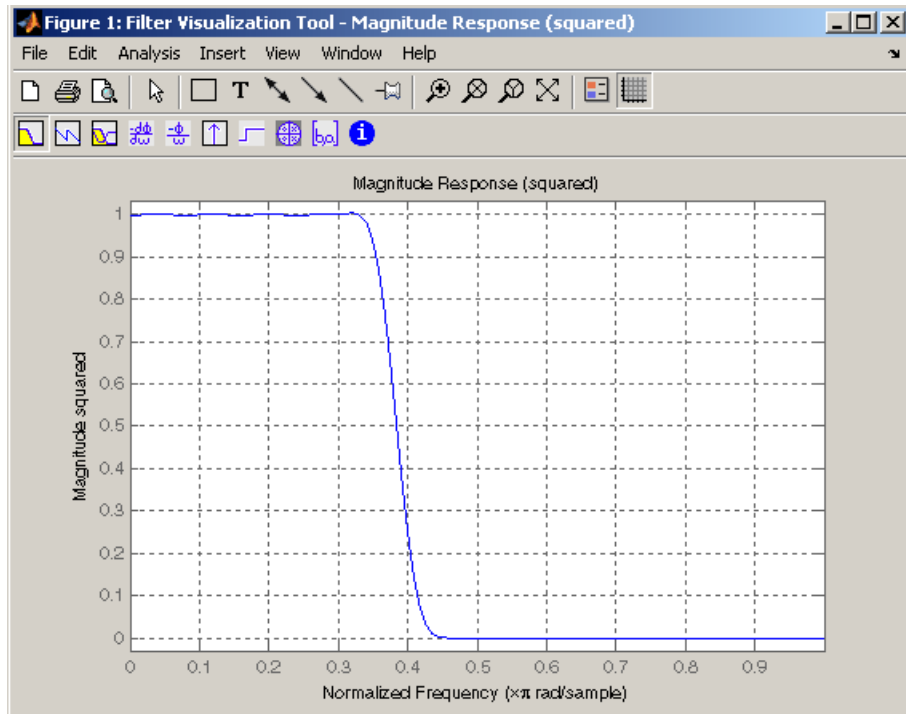

Using a Hamming window greatly reduces the ringing. This improvement is at the expense of transition width (the windowed version takes longer to ramp from passband to stopband) and optimality (the windowed version does not minimize the integrated squared error).

The functions `fir1` and `fir2` are based on this windowing process. Given a filter order and description of an ideal desired filter, these functions return a windowed inverse Fourier transform of that ideal filter. Both use a Hamming window by default, but they accept any window function. See “Windows” on page 7-2 for an overview of windows and their properties.

## Standard Band FIR Filter Design: `fir1`

`fir1` implements the classical method of windowed linear phase FIR digital filter design. It resembles the IIR filter design functions in that it is formulated to design filters in standard band configurations: lowpass, bandpass, highpass, and bandstop.

The statements

```
n = 50;  
Wn = 0.4;  
b = fir1(n,Wn);
```

create row vector `b` containing the coefficients of the order `n` Hamming-windowed filter. This is a lowpass, linear phase FIR filter with cutoff frequency `Wn`. `Wn` is a number between 0 and 1, where 1 corresponds to the Nyquist frequency, half the sampling frequency. (Unlike other methods, here `Wn` corresponds to the 6 dB point.) For a highpass filter, simply append the string 'high' to the function's parameter list. For a bandpass or bandstop filter, specify `Wn` as a two-element vector containing the passband edge frequencies; append the string 'stop' for the bandstop configuration.

`b = fir1(n,Wn>window)` uses the window specified in column vector `window` for the design. The vector `window` must be `n+1` elements long. If you do not specify a window, `fir1` applies a Hamming window.

**Kaiser Window Order Estimation.** The `kaiserord` function estimates the filter order, cutoff frequency, and Kaiser window beta parameter needed to meet a given set of specifications. Given a vector of frequency band edges and a corresponding vector of magnitudes, as well as maximum allowable ripple, `kaiserord` returns appropriate input parameters for the `fir1` function.

## Multiband FIR Filter Design: `fir2`

The `fir2` function also designs windowed FIR filters, but with an arbitrarily shaped piecewise linear frequency response. This is in contrast to `fir1`, which only designs filters in standard lowpass, highpass, bandpass, and bandstop configurations.

The commands

```
n = 50;  
f = [0 .4 .5 1];  
m = [1 1 0 0];  
b = fir2(n,f,m);
```

return row vector **b** containing the  $n+1$  coefficients of the order  $n$  FIR filter whose frequency-magnitude characteristics match those given by vectors **f** and **m**. **f** is a vector of frequency points ranging from 0 to 1, where 1 represents the Nyquist frequency. **m** is a vector containing the desired magnitude response at the points specified in **f**. (The IIR counterpart of this function is `yulewalk`, which also designs filters based on arbitrary piecewise linear magnitude responses. See “IIR Filter Design” on page 2-4 for details.)

## Multiband FIR Filter Design with Transition Bands

The `firls` and `firpm` functions provide a more general means of specifying the ideal desired filter than the `fir1` and `fir2` functions. These functions design Hilbert transformers, differentiators, and other filters with odd symmetric coefficients (type III and type IV linear phase). They also let you include transition or “don’t care” regions in which the error is not minimized, and perform band dependent weighting of the minimization.

The `firls` function is an extension of the `fir1` and `fir2` functions in that it minimizes the integral of the square of the error between the desired frequency response and the actual frequency response.

The `firpm` function implements the Parks-McClellan algorithm, which uses the Remez exchange algorithm and Chebyshev approximation theory to design filters with optimal fits between the desired and actual frequency responses. The filters are optimal in the sense that they minimize the maximum error between the desired frequency response and the actual frequency response; they are sometimes called *minimax* filters. Filters designed in this way exhibit an equiripple behavior in their frequency response, and hence are also known as *equiripple* filters. The Parks-McClellan FIR filter design algorithm is perhaps the most popular and widely used FIR filter design methodology.

The syntax for `firls` and `firpm` is the same; the only difference is their minimization schemes. The next example shows how filters designed with `firls` and `firpm` reflect these different schemes.

## Basic Configurations

The default mode of operation of `firls` and `firpm` is to design type I or type II linear phase filters, depending on whether the order you desire is even or odd, respectively. A lowpass example with approximate amplitude 1 from 0 to 0.4 Hz, and approximate amplitude 0 from 0.5 to 1.0 Hz is

```
n = 20;                % Filter order
f = [0 0.4 0.5 1];    % Frequency band edges
a = [1 1 0 0];        % Desired amplitudes
b = firpm(n,f,a);
```

From 0.4 to 0.5 Hz, `firpm` performs no error minimization; this is a transition band or “don’t care” region. A transition band minimizes the error more in the bands that you do care about, at the expense of a slower transition rate. In this way, these types of filters have an inherent trade-off similar to FIR design by windowing.

To compare least squares to equiripple filter design, use `firls` to create a similar filter. Type

```
bb = firls(n,f,a);
```

and compare their frequency responses using `FVTool`:

```
fvtool(b,1,bb,1)
```

Note that the y-axis shown in the figure below is in Magnitude Squared. You can set this by right-clicking on the axis label and selecting **Magnitude Squared** from the menu.

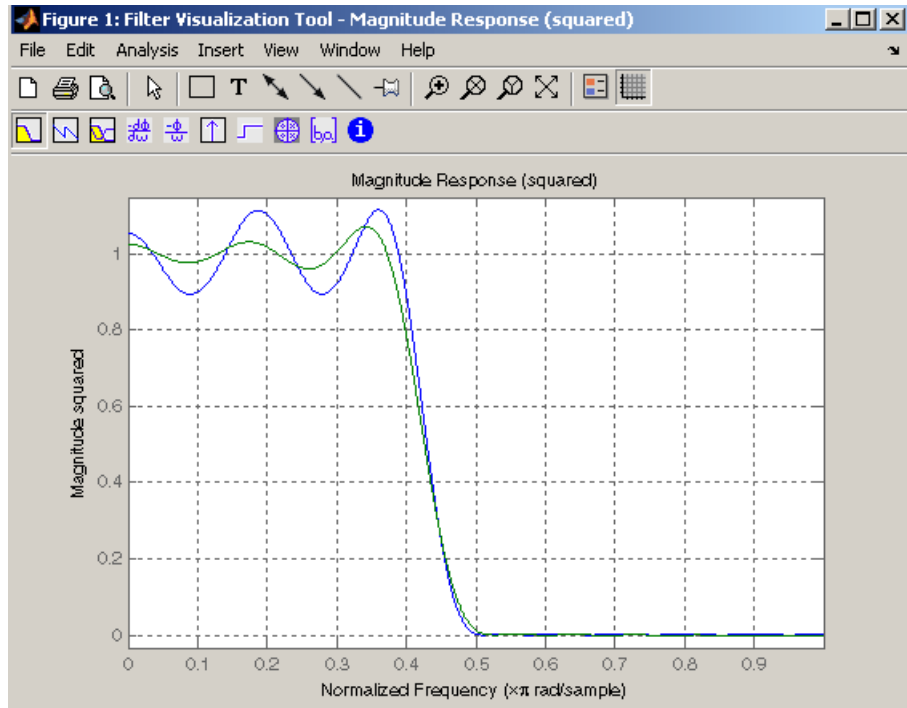

The filter designed with `firpm` exhibits equiripple behavior. Also note that the `fir1s` filter has a better response over most of the passband and stopband, but at the band edges ( $f = 0.4$  and  $f = 0.5$ ), the response is further away from the ideal than the `firpm` filter. This shows that the `firpm` filter's *maximum* error over the passband and stopband is smaller and, in fact, it is the smallest possible for this band edge configuration and filter length.

Think of frequency bands as lines over short frequency intervals. `firpm` and `fir1s` use this scheme to represent any piecewise linear desired function with any transition bands. `fir1s` and `firpm` design lowpass, highpass, bandpass, and bandstop filters; a bandpass example is

```
f = [0 0.3 0.4 0.7 0.8 1]; % Band edges in pairs
```

```
a = [0 0 1 1 0 0]; % Bandpass filter amplitude
```

Technically, these `f` and `a` vectors define five bands:

- Two stopbands, from 0.0 to 0.3 and from 0.8 to 1.0
- A passband from 0.4 to 0.7
- Two transition bands, from 0.3 to 0.4 and from 0.7 to 0.8

Example highpass and bandstop filters are

```
f = [0 0.7 0.8 1]; % Band edges in pairs
a = [0 0 1 1]; % Highpass filter amplitude
f = [0 0.3 0.4 0.5 0.8 1]; % Band edges in pairs
a = [1 1 0 0 1 1]; % Bandstop filter amplitude
```

An example multiband bandpass filter is

```
f = [0 0.1 0.15 0.25 0.3 0.4 0.45 0.55 0.6 0.7 0.75 0.85 0.9 1];
a = [1 1 0 0 1 1 0 0 1 1 0 0 1 1];
```

Another possibility is a filter that has as a transition region the line connecting the passband with the stopband; this can help control “runaway” magnitude response in wide transition regions:

```
f = [0 0.4 0.42 0.48 0.5 1];
a = [1 1 0.8 0.2 0 0]; % Passband, linear transition,
                        % stopband
```

## The Weight Vector

Both `firls` and `firpm` allow you to place more or less emphasis on minimizing the error in certain frequency bands relative to others. To do this, specify a weight vector following the frequency and amplitude vectors. An example lowpass equiripple filter with 10 times less ripple in the stopband than the passband is

```
n = 20; % Filter order
f = [0 0.4 0.5 1]; % Frequency band edges
a = [1 1 0 0]; % Desired amplitudes
```

```
w = [1 10];           % Weight vector  
b = firpm(n,f,a,w);
```

A legal weight vector is always half the length of the `f` and `a` vectors; there must be exactly one weight per band.

### **Anti-Symmetric Filters / Hilbert Transformers**

When called with a trailing 'h' or 'Hilbert' option, `firpm` and `firls` design FIR filters with odd symmetry, that is, type III (for even order) or type IV (for odd order) linear phase filters. An ideal Hilbert transformer has this anti-symmetry property and an amplitude of 1 across the entire frequency range. Try the following approximate Hilbert transformers and plot them using `FVTool`:

```
b = firpm(21,[0.05 1],[1 1],'h');           % Highpass Hilbert  
bb = firpm(20,[0.05 0.95],[1 1],'h');      % Bandpass Hilbert  
fvtool(b,1,bb,1)
```



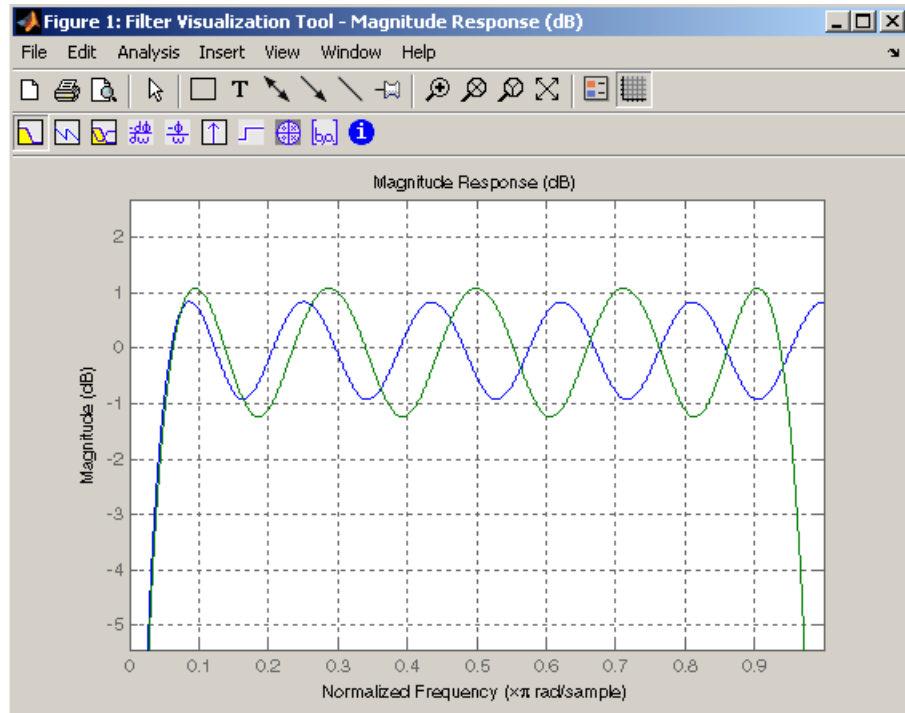

You can find the delayed Hilbert transform of a signal  $x$  by passing it through these filters.

```
fs = 1000;           % Sampling frequency
t = (0:1/fs:2)';    % Two second time vector
x = sin(2*pi*300*t); % 300 Hz sine wave example signal
xh = filter(bb,1,x); % Hilbert transform of x
```

The analytic signal corresponding to  $x$  is the complex signal that has  $x$  as its real part and the Hilbert transform of  $x$  as its imaginary part. For this FIR method (an alternative to the `hilbert` function), you must delay  $x$  by half the filter order to create the analytic signal:

```
xd = [zeros(10,1); x(1:length(x)-10)]; % Delay 10 samples
xa = xd + j*xh;                          % Analytic signal
```

This method does not work directly for filters of odd order, which require a noninteger delay. In this case, the `hilbert` function, described in “Specialized Transforms” on page 7-36, estimates the analytic signal. Alternatively, use the `resample` function to delay the signal by a noninteger number of samples.

### Differentiators

Differentiation of a signal in the time domain is equivalent to multiplication of the signal’s Fourier transform by an imaginary ramp function. That is, to differentiate a signal, pass it through a filter that has a response  $H(\omega) = j\omega$ . Approximate the ideal differentiator (with a delay) using `firpm` or `firls` with a 'd' or 'differentiator' option:

```
b = firpm(21,[0 1],[0 pi], 'd');
```

For a type III filter, the differentiation band should stop short of the Nyquist frequency, and the amplitude vector must reflect that change to ensure the correct slope:

```
bb = firpm(20,[0 0.9],[0 0.9*pi], 'd');
```

In the 'd' mode, `firpm` weights the error by  $1/\omega$  in nonzero amplitude bands to minimize the maximum *relative* error. `firls` weights the error by  $(1/\omega)^2$  in nonzero amplitude bands in the 'd' mode.

The following plots show the magnitude responses for the differentiators above.

```
fvtool(b,1,bb,1)
```

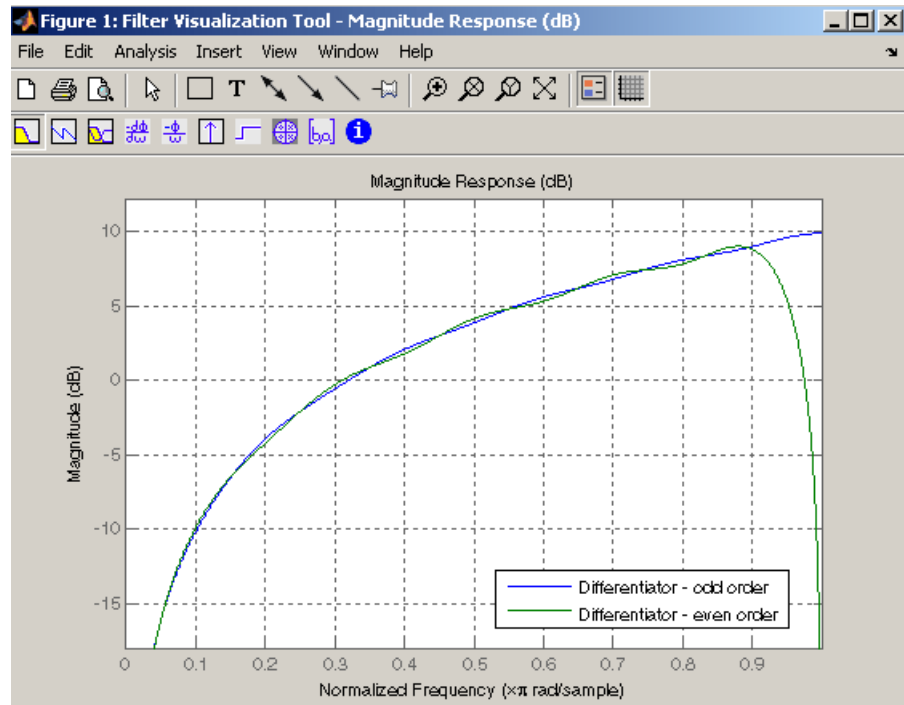

## Constrained Least Squares FIR Filter Design

The Constrained Least Squares (CLS) FIR filter design functions implement a technique that enables you to design FIR filters without explicitly defining the transition bands for the magnitude response. The ability to omit the specification of transition bands is useful in several situations. For example, it may not be clear where a rigidly defined transition band should appear if noise and signal information appear together in the same frequency band. Similarly, it may make sense to omit the specification of transition bands if they appear only to control the results of Gibbs phenomena that appear in the filter's response. See Selesnick, Lang, and Burrus [2] for discussion of this method.

Instead of defining passbands, stopbands, and transition regions, the CLS method accepts a cutoff frequency (for the highpass, lowpass, bandpass, or bandstop cases), or passband and stopband edges (for multiband cases), for the desired response. In this way, the CLS method defines transition regions implicitly, rather than explicitly.

The key feature of the CLS method is that it enables you to define upper and lower thresholds that contain the maximum allowable ripple in the magnitude response. Given this constraint, the technique applies the least square error minimization technique over the frequency range of the filter's response, instead of over specific bands. The error minimization includes any areas of discontinuity in the ideal, "brick wall" response. An additional benefit is that the technique enables you to specify arbitrarily small peaks resulting from Gibbs' phenomena.

There are two toolbox functions that implement this design technique.

<b>Description</b>	<b>Function</b>
Constrained least square multiband FIR filter design	<code>fircls</code>
Constrained least square filter design for lowpass and highpass linear phase filters	<code>fircls1</code>

For details on the calling syntax for these functions, see their reference descriptions in the Function Reference.

### **Basic Lowpass and Highpass CLS Filter Design**

The most basic of the CLS design functions, `fircls1`, uses this technique to design lowpass and highpass FIR filters. As an example, consider designing a filter with order 61 impulse response and cutoff frequency of 0.3 (normalized). Further, define the upper and lower bounds that constrain the design process as:

- Maximum passband deviation from 1 (passband ripple) of 0.02.
- Maximum stopband deviation from 0 (stopband ripple) of 0.008.

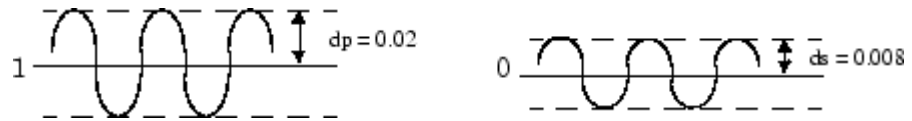

To approach this design problem using `fircls1`, use the following commands:

```
n = 61;
wo = 0.3;
dp = 0.02;
ds = 0.008;
h = fircls1(n,wo,dp,ds);
fvtool(h,1)
```

Note that the y-axis shown below is in Magnitude Squared. You can set this by right-clicking on the axis label and selecting **Magnitude Squared** from the menu.

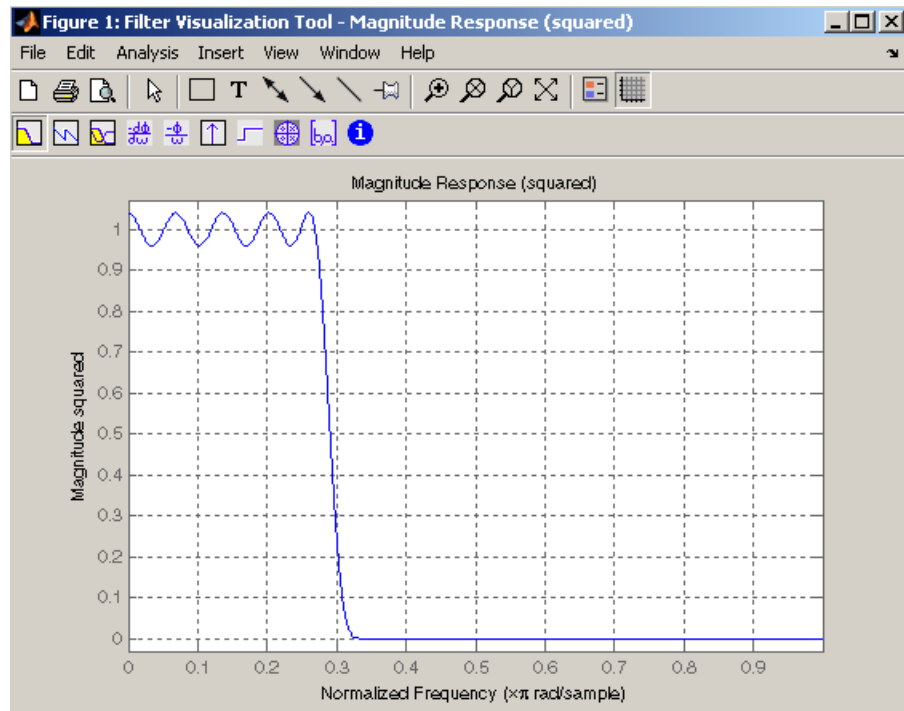

### Multiband CLS Filter Design

`fircls` uses the same technique to design FIR filters with a desired piecewise constant magnitude response. In this case, you can specify a vector of band edges and a corresponding vector of band amplitudes. In addition, you can specify the maximum amount of ripple for each band.

For example, assume the specifications for a filter call for:

- From 0 to 0.3 (normalized): amplitude 0, upper bound 0.005, lower bound  $-0.005$
- From 0.3 to 0.5: amplitude 0.5, upper bound 0.51, lower bound 0.49
- From 0.5 to 0.7: amplitude 0, upper bound 0.03, lower bound  $-0.03$
- From 0.7 to 0.9: amplitude 1, upper bound 1.02, lower bound 0.98
- From 0.9 to 1: amplitude 0, upper bound 0.05, lower bound  $-0.05$

Design a CLS filter with impulse response order 129 that meets these specifications:

```
n = 129;  
f = [0 0.3 0.5 0.7 0.9 1];  
a = [0 0.5 0 1 0];  
up = [0.005 0.51 0.03 1.02 0.05];  
lo = [-0.005 0.49 -0.03 0.98 -0.05];  
h = fircls(n,f,a,up,lo);  
fvtool(h,1)
```

Note that the y-axis shown below is in Magnitude Squared. You can set this by right-clicking on the axis label and selecting **Magnitude Squared** from the menu.

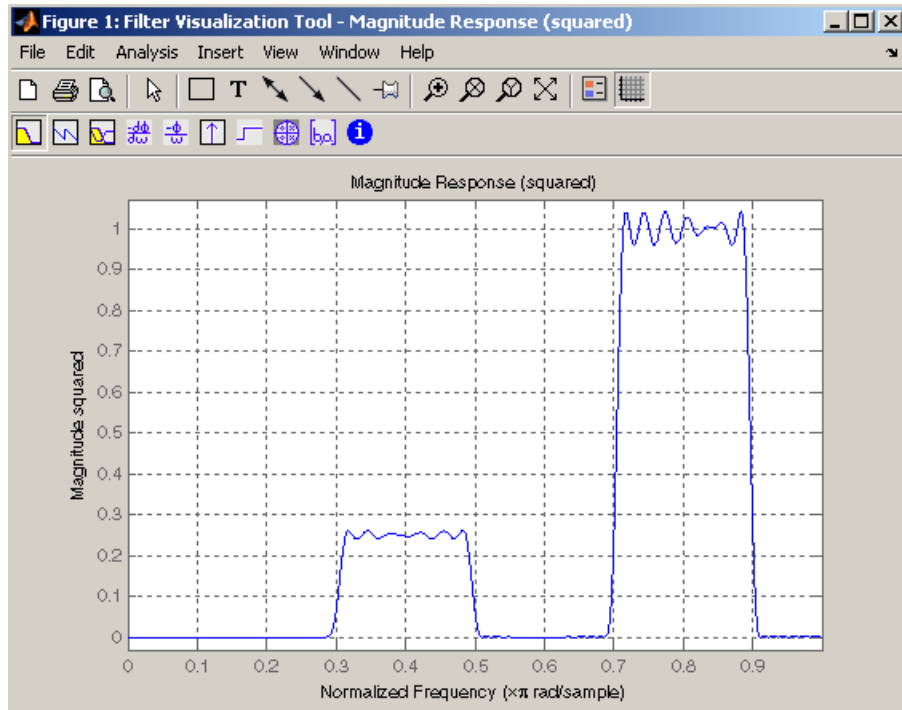

## Weighted CLS Filter Design

Weighted CLS filter design lets you design lowpass or highpass FIR filters with relative weighting of the error minimization in each band. The `fircls1` function enables you to specify the passband and stopband edges for the least squares weighting function, as well as a constant  $k$  that specifies the ratio of the stopband to passband weighting.

For example, consider specifications that call for an FIR filter with impulse response order of 55 and cutoff frequency of 0.3 (normalized). Also assume maximum allowable passband ripple of 0.02 and maximum allowable stopband ripple of 0.004. In addition, add weighting requirements:

- Passband edge for the weight function of 0.28 (normalized)
- Stopband edge for the weight function of 0.32
- Weight error minimization 10 times as much in the stopband as in the passband

To approach this using `fircls1`, type

```
n = 55;
wo = 0.3;
dp = 0.02;
ds = 0.004;
wp = 0.28;
ws = 0.32;
k = 10;
h = fircls1(n,wo,dp,ds,wp,ws,k);
fvtool(h,1)
```



Note that the y-axis shown below is in Magnitude Squared. You can set this by right-clicking on the axis label and selecting **Magnitude Squared** from the menu.

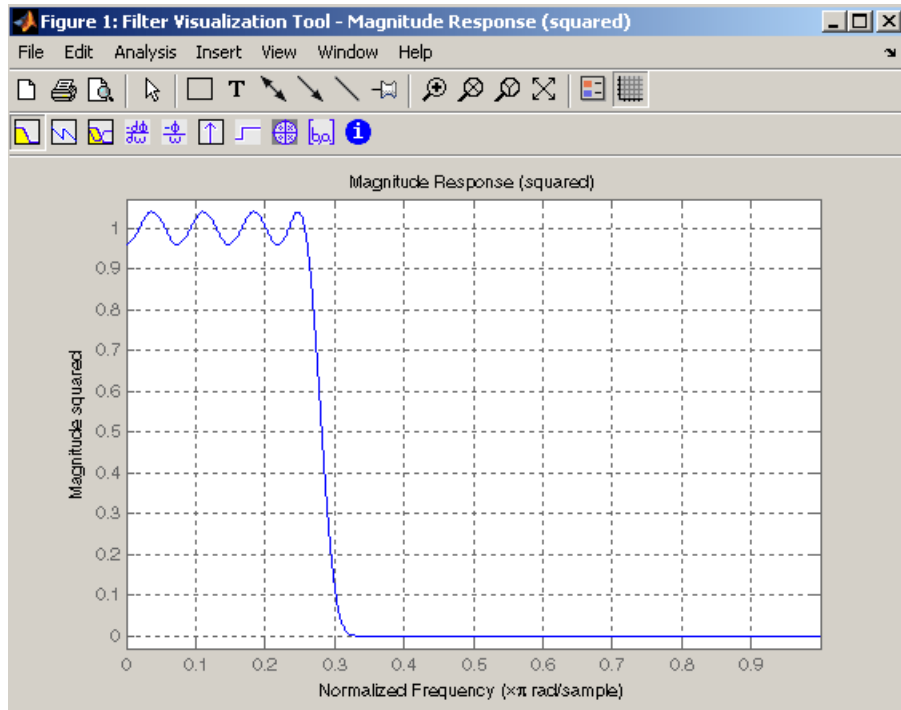

## Arbitrary-Response Filter Design

The `cfirpm` filter design function provides a tool for designing FIR filters with arbitrary complex responses. It differs from the other filter design functions in how the frequency response of the filter is specified: it accepts the name of a function which returns the filter response calculated over a grid of frequencies. This capability makes `cfirpm` a highly versatile and powerful technique for filter design.

This design technique may be used to produce nonlinear-phase FIR filters, asymmetric frequency-response filters (with complex coefficients), or more symmetric filters with custom frequency responses.

The design algorithm optimizes the Chebyshev (or minimax) error using an extended Remez-exchange algorithm for an initial estimate. If this exchange method fails to obtain the optimal filter, the algorithm switches to an ascent-descent algorithm that takes over to finish the convergence to the optimal solution.

### Multiband Filter Design

Consider a multiband filter with the following special frequency-domain characteristics.

Band	Amplitude	Optimization Weighting
[-1 -0.5]	[5 1]	1
[-0.4 +0.3]	[2 2]	10
[+0.4 +0.8]	[2 1]	5

A linear-phase multiband filter may be designed using the predefined frequency-response function `multiband`, as follows:

```
b = cfirpm(38, [-1 -0.5 -0.4 0.3 0.4 0.8], ...  
            {'multiband', [5 1 2 2 2 1]}, [1 10 5]);
```

For the specific case of a multiband filter, we can use a shorthand filter design notation similar to the syntax for `firpm`:

```
b = cfirpm(38, [-1 -0.5 -0.4 0.3 0.4 0.8], ...  
            [5 1 2 2 2 1], [1 10 5]);
```

As with `firpm`, a vector of band edges is passed to `cfirpm`. This vector defines the frequency bands over which optimization is performed; note that there are two transition bands, from  $-0.5$  to  $-0.4$  and from  $0.3$  to  $0.4$ .

In either case, the frequency response is obtained and plotted using linear scale in `FVTool`:

```
fvtool(b,1)
```

Note that the range of data shown below is  $(-F_s/2, F_s/2)$ . You can set this range by changing the  $x$ -axis units to **Frequency ( $F_s = 1$  Hz)**.

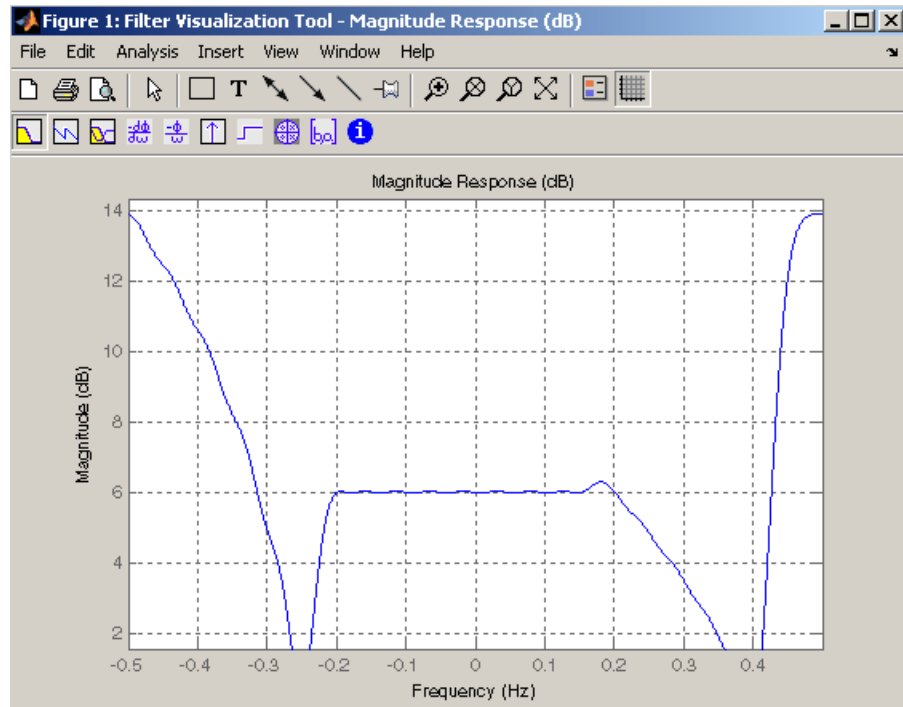

The filter response for this multiband filter is complex, which is expected because of the asymmetry in the frequency domain. The impulse response, which you can select from the FVTool toolbar, is shown below.

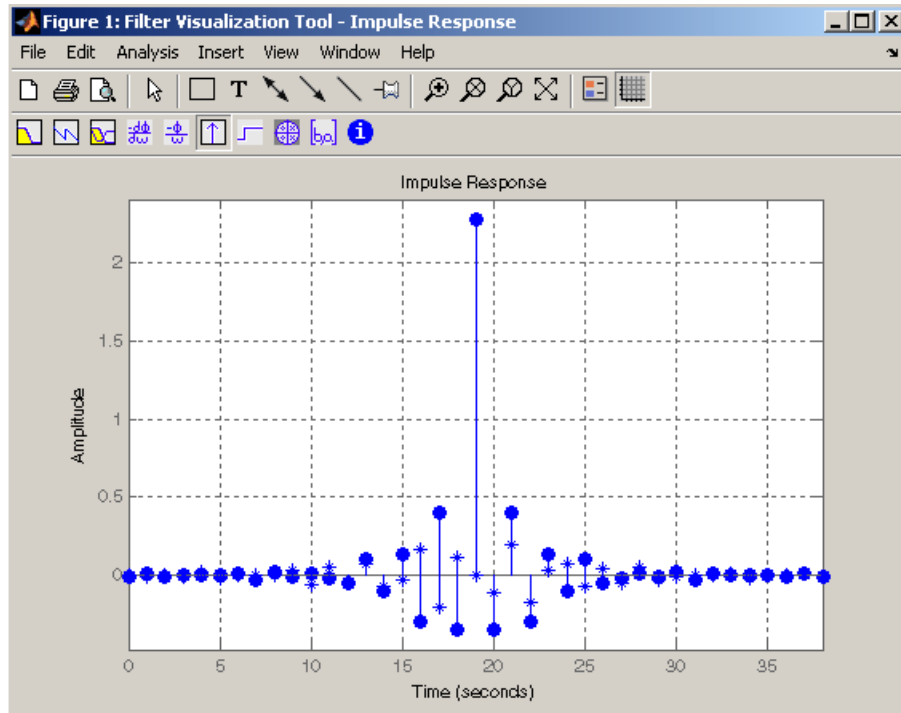

### Filter Design with Reduced Delay

Consider the design of a 62-tap lowpass filter with a half-Nyquist cutoff. If we specify a negative offset value to the `lowpass` filter design function, the group delay offset for the design is significantly less than that obtained for a standard linear-phase design. This filter design may be computed as follows:

```
b = cfirpm(61,[0 0.5 0.55 1],{'lowpass',-16});
```

The resulting magnitude response is

```
fvtool(b,1)
```

Note that the range of data in this plot is  $(-F_s/2, F_s/2)$ , which you can set changing the  $x$ -axis units to **Frequency**. The  $y$ -axis is in Magnitude Squared, which you can set by right-clicking on the axis label and selecting **Magnitude Squared** from the menu.

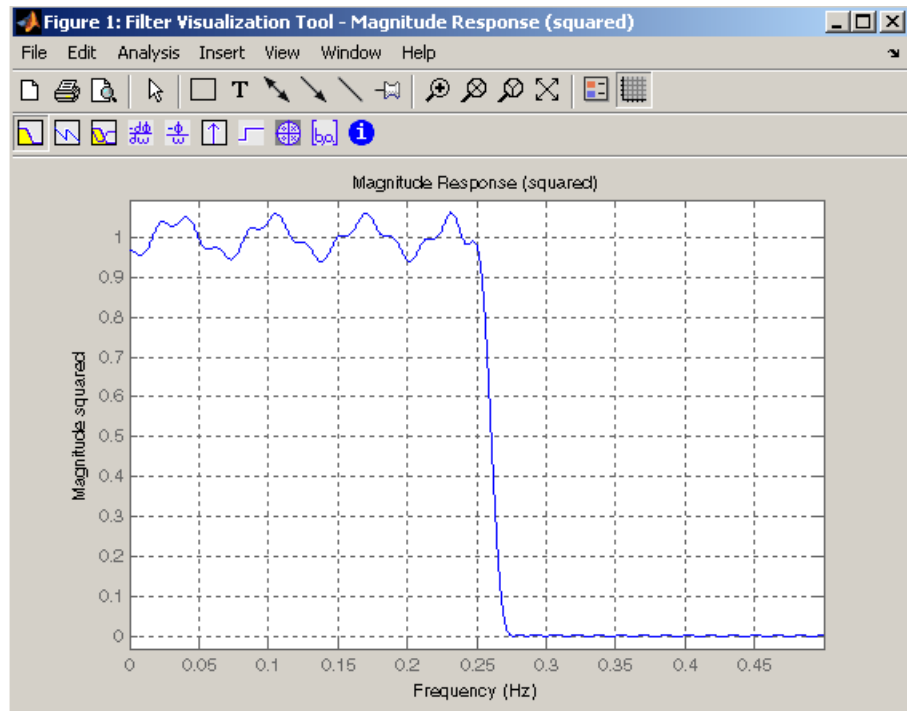

The group delay of the filter reveals that the offset has been reduced from  $N/2$  to  $N/2 - 16$  (i.e., from 30.5 to 14.5). Now, however, the group delay is no longer flat in the passband region. To create this plot, click the **Group Delay** button on the toolbar.

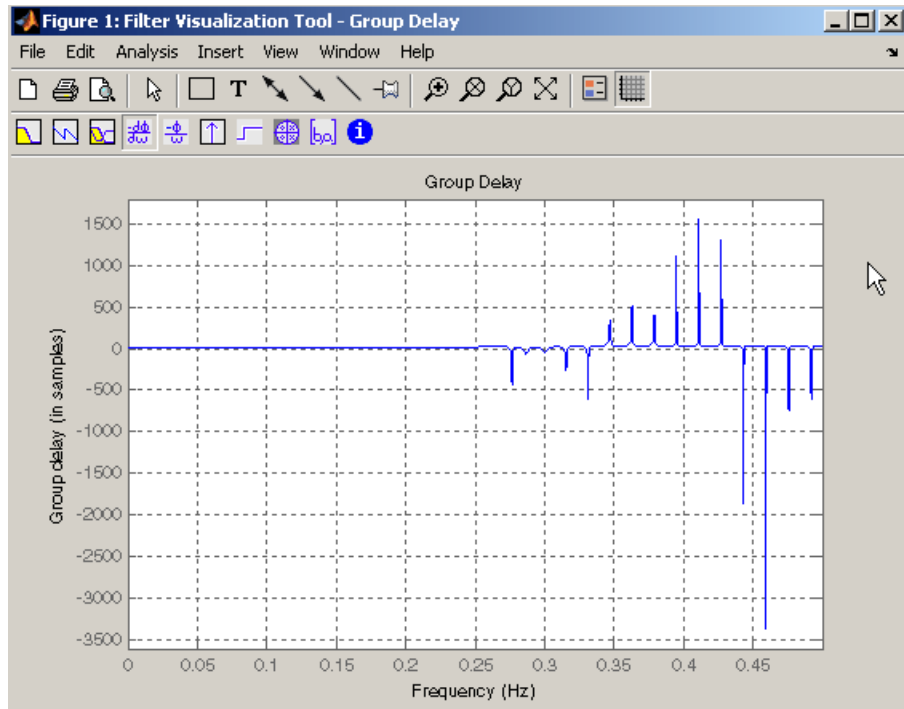

If we compare this nonlinear-phase filter to a linear-phase filter that has exactly 14.5 samples of group delay, the resulting filter is of order  $2 \times 14.5$ , or 29. Using `b = cfirpm(29,[0 0.5 0.55 1], 'lowpass')`, the passband and stopband ripple is much greater for the order 29 filter. These comparisons can assist you in deciding which filter is more appropriate for a specific application.

## Special Topics in IIR Filter Design

### In this section...

- “Classic IIR Filter Design” on page 2-43
- “Analog Prototype Design” on page 2-44
- “Frequency Transformation” on page 2-44
- “Filter Discretization” on page 2-46

### Classic IIR Filter Design

The classic IIR filter design technique includes the following steps.

- 1** Find an analog lowpass filter with cutoff frequency of 1 and translate this prototype filter to the desired band configuration
- 2** Transform the filter to the digital domain.
- 3** Discretize the filter.

The toolbox provides functions for each of these steps.

Design Task	Available functions
Analog lowpass prototype	buttap, cheb1ap, besslap, ellipap, cheb2ap
Frequency transformation	lp2lp, lp2hp, lp2bp, lp2bs
Discretization	bilinear,impinvar

Alternatively, the `butter`, `cheby1`, `cheb2ord`, `ellip`, and `besself` functions perform all steps of the filter design and the `buttor`, `cheb1ord`, `cheb2ord`, and `ellipord` functions provide minimum order computation for IIR filters. These functions are sufficient for many design problems, and the lower level functions are generally not needed. But if you do have an application where you need to transform the band edges of an analog filter, or discretize a rational transfer function, this section describes the tools with which to do so.

## Analog Prototype Design

This toolbox provides a number of functions to create lowpass analog prototype filters with cutoff frequency of 1, the first step in the classical approach to IIR filter design.

The table below summarizes the analog prototype design functions for each supported filter type; plots for each type are shown in “IIR Filter Design” on page 2-4.

Filter Type	Analog Prototype Function
Bessel	[z,p,k] = besslap(n)
Butterworth	[z,p,k] = buttap(n)
Chebyshev Type I	[z,p,k] = cheb1ap(n,Rp)
Chebyshev Type II	[z,p,k] = cheb2ap(n,Rs)
Elliptic	[z,p,k] = ellipap(n,Rp,Rs)

## Frequency Transformation

The second step in the analog prototyping design technique is the frequency transformation of a lowpass prototype. The toolbox provides a set of functions to transform analog lowpass prototypes (with cutoff frequency of 1 rad/s) into bandpass, highpass, bandstop, and lowpass filters of the desired cutoff frequency.

Frequency Transformation	Transformation Function
Lowpass to lowpass $s' = s / \omega_0$	[numt,dent] = lp2lp (num,den,Wo) [At,Bt,Ct,Dt] = lp2lp (A,B,C,D,Wo)
Lowpass to highpass $s' = \frac{\omega_0}{s}$	[numt,dent] = lp2hp (num,den,Wo) [At,Bt,Ct,Dt] = lp2hp (A,B,C,D,Wo)



Frequency Transformation	Transformation Function
Lowpass to bandpass $s' = \frac{\omega_0}{B_\omega} \frac{(s / \omega_0)^2 + 1}{s / \omega_0}$	$[numt, dent] = lp2bp (num, den, Wo, Bw)$ $[At, Bt, Ct, Dt] = lp2bp (A, B, C, D, Wo, Bw)$
Lowpass to bandstop $s' = \frac{B_\omega}{\omega_0} \frac{s / \omega_0}{(s / \omega_0)^2 + 1}$	$[numt, dent] = lp2bs (num, den, Wo, Bw)$ $[At, Bt, Ct, Dt] = lp2bs (A, B, C, D, Wo, Bw)$

As shown, all of the frequency transformation functions can accept two linear system models: transfer function and state-space form. For the bandpass and bandstop cases

$$\omega_0 = \sqrt{\omega_1 \omega_2}$$

and

$$B_\omega = \omega_2 - \omega_1$$

where  $\omega_1$  is the lower band edge and  $\omega_2$  is the upper band edge.

The frequency transformation functions perform frequency variable substitution. In the case of `lp2bp` and `lp2bs`, this is a second-order substitution, so the output filter is twice the order of the input. For `lp2lp` and `lp2hp`, the output filter is the same order as the input.

To begin designing an order 10 bandpass Chebyshev Type I filter with a value of 3 dB for passband ripple, enter

```
[z,p,k] = cheb1ap(10,3);
```

Outputs `z`, `p`, and `k` contain the zeros, poles, and gain of a lowpass analog filter with cutoff frequency  $\Omega_c$  equal to 1 rad/s. Use the `lp2bp` function to transform this lowpass prototype to a bandpass analog filter with band edges

$\Omega_1 = \pi/5$  and  $\Omega_2 = \pi$ . First, convert the filter to state-space form so the `lp2bp` function can accept it:

```
[A,B,C,D] = zp2ss(z,p,k); % Convert to state-space form.
```

Now, find the bandwidth and center frequency, and call `lp2bp`:

```
u1 = 0.1*2*pi; u2 = 0.5*2*pi; % In radians per second
Bw = u2-u1;
Wo = sqrt(u1*u2);
[At,Bt,Ct,Dt] = lp2bp(A,B,C,D,Wo,Bw);
```

Finally, calculate the frequency response and plot its magnitude:

```
[b,a] = ss2tf(At,Bt,Ct,Dt); % Convert to TF form
w = linspace(0.01,1,500)*2*pi; % Generate frequency vector
h = freqs(b,a,w); % Compute frequency response
semilogy(w/2/pi,abs(h)), grid % Plot log magnitude vs. freq
xlabel('Frequency (Hz)');
```

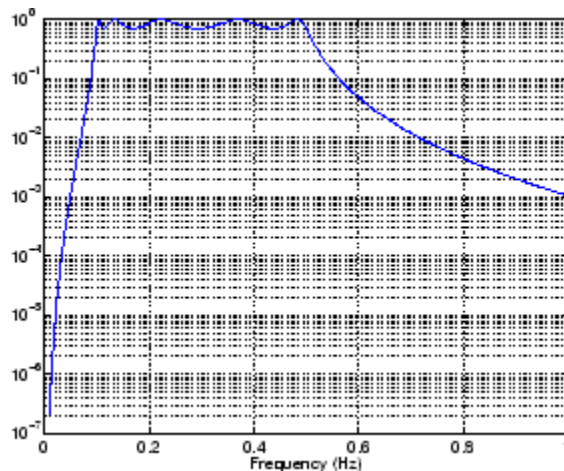

## Filter Discretization

The third step in the analog prototyping technique is the transformation of the filter to the discrete-time domain. The toolbox provides two methods for this: the impulse invariant and bilinear transformations. The filter design

functions `butter`, `cheby1`, `cheby2`, and `ellip` use the bilinear transformation for discretization in this step.

Analog to Digital Transformation	Transformation Function
Impulse invariance	$[numd, dend] = \text{impinvar}(num, den, fs)$
Bilinear transform	$[zd, pd, kd] = \text{bilinear}(z, p, k, fs, Fp)$ $[numd, dend] = \text{bilinear}(num, den, fs, Fp)$ $[Ad, Bd, Cd, Dd] = \text{bilinear}(At, Bt, Ct, Dt, fs, Fp)$

### Impulse Invariance

The toolbox function `impinvar` creates a digital filter whose impulse response is the samples of the continuous impulse response of an analog filter. This function works only on filters in transfer function form. For best results, the analog filter should have negligible frequency content above half the sampling frequency, because such high frequency content is aliased into lower bands upon sampling. Impulse invariance works for some lowpass and bandpass filters, but is not appropriate for highpass and bandstop filters.

Design a Chebyshev Type I filter and plot its frequency and phase response using FVTool:

```
[bz, az] =impinvar(b, a, 2);
fvtool(bz, az)
```

Click the **Magnitude and Phase Response** toolbar button.

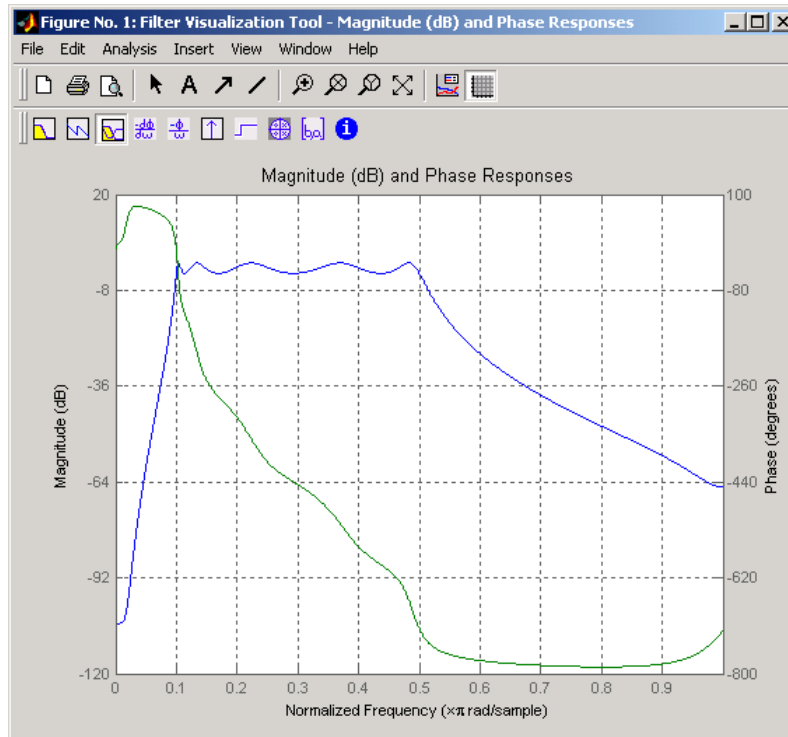

Impulse invariance retains the cutoff frequencies of 0.1 Hz and 0.5 Hz.

### Bilinear Transformation

The bilinear transformation is a nonlinear mapping of the continuous domain to the discrete domain; it maps the  $s$ -plane into the  $z$ -plane by

$$H(z) = H(s) \Big|_{s=k \frac{z-1}{z+1}}$$

Bilinear transformation maps the  $j\Omega$ -axis of the continuous domain to the unit circle of the discrete domain according to

$$\omega = 2 \tan^{-1} \left( \frac{\Omega}{k} \right)$$

The toolbox function `bilinear` implements this operation, where the frequency warping constant  $k$  is equal to twice the sampling frequency ( $2 \cdot f_s$ )

by default, and equal to  $2\pi f_p / \tan(\pi f_p / f_s)$  if you give `bilinear` a trailing argument that represents a “match” frequency  $F_p$ . If a match frequency  $F_p$  (in hertz) is present, `bilinear` maps the frequency  $\Omega = 2\pi f_p$  (in rad/s) to the same frequency in the discrete domain, normalized to the sampling rate:  $\omega = 2\pi f_p / f_s$  (in rad/sample).

The `bilinear` function can perform this transformation on three different linear system representations: zero-pole-gain, transfer function, and state-space form. Try calling `bilinear` with the state-space matrices that describe the Chebyshev Type I filter from the previous section, using a sampling frequency of 2 Hz, and retaining the lower band edge of 0.1 Hz:

```
[Ad,Bd,Cd,Dd] = bilinear(At,Bt,Ct,Dt,2,0.1);
```

The frequency response of the resulting digital filter is

```
[bz,az] = ss2tf(Ad,Bd,Cd,Dd);           % Convert to TF
fvtool(bz,az)
```

Click the **Magnitude and Phase Response** toolbar button.

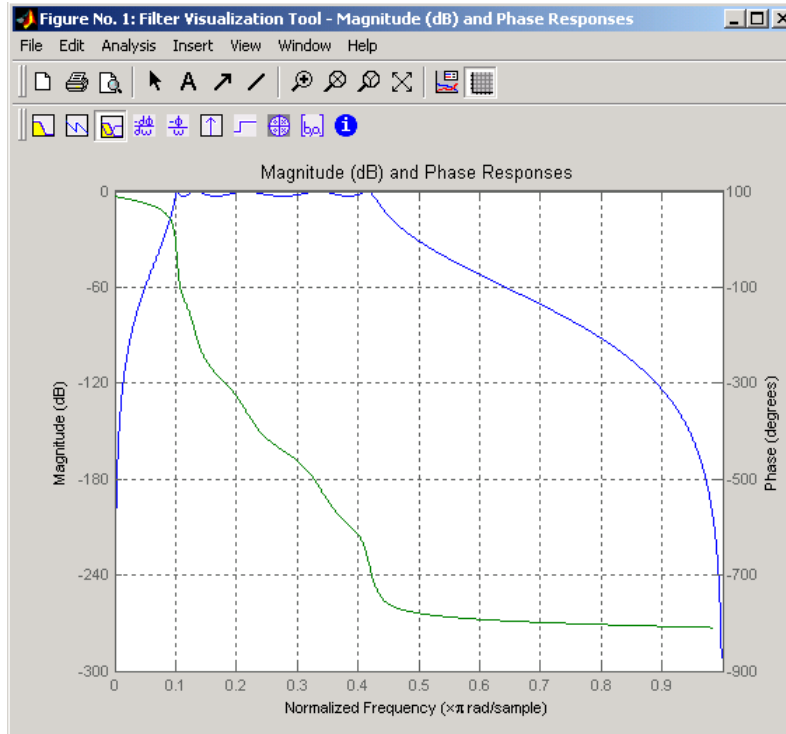

The lower band edge is at 0.1 Hz as expected. Notice, however, that the upper band edge is slightly less than 0.5 Hz, although in the analog domain it was exactly 0.5 Hz. This illustrates the nonlinear nature of the bilinear transformation. To counteract this nonlinearity, it is necessary to create analog domain filters with “prewarped” band edges, which map to the correct locations upon bilinear transformation. Here the prewarped frequencies  $u_1$  and  $u_2$  generate  $Bw$  and  $Wo$  for the `lp2bp` function:

```
fs = 2; % Sampling frequency (hertz)
u1 = 2*fs*tan(0.1*(2*pi/fs)/2); % Lower band edge (rad/s)
u2 = 2*fs*tan(0.5*(2*pi/fs)/2); % Upper band edge (rad/s)
Bw = u2 - u1; % Bandwidth
Wo = sqrt(u1*u2); % Center frequency
[At,Bt,Ct,Dt] = lp2bp(A,B,C,D,Wo,Bw);
```

A digital bandpass filter with correct band edges 0.1 and 0.5 times the Nyquist frequency is

```
[Ad,Bd,Cd,Dd] = bilinear(At,Bt,Ct,Dt,fs);
```

The example bandpass filters from the last two sections could also be created in one statement using the complete IIR design function `cheby1`. For instance, an analog version of the example Chebyshev filter is

```
[b,a] = cheby1(5,3,[0.1 0.5]*2*pi,'s');
```

Note that the band edges are in rad/s for analog filters, whereas for the digital case, frequency is normalized:

```
[bz,az] = cheby1(5,3,[0.1 0.5]);
```

All of the complete design functions call `bilinear` internally. They prewarp the band edges as needed to obtain the correct digital filter.

## Filtering Data With Signal Processing Toolbox Software

In this section...
“Lowpass FIR Filter — Window Method” on page 2-52
“Bandpass Filters — Minimum-Order FIR and IIR Systems” on page 2-56
“Zero-Phase Filtering” on page 2-65

### Lowpass FIR Filter — Window Method

These examples show you how to design and implement an FIR filter using the command line functions: `fir1` and `fdesign.lowpass`, and the interactive tool `fdatool`.

To filter the input signal, these examples use the `filter` command. The examples in “Zero-Phase Filtering” on page 2-65 show you how to implement zero-phase filtering with `filtfilt`.

Create a signal to use in the examples. The signal is a 100-Hz sinusoid in additive  $N(0,1/4)$  white Gaussian noise. Set the random number generator to the default state for reproducible results.

```
rng default;  
Fs = 1000;  
t = linspace(0,1,Fs);  
x = cos(2*pi*100*t)+0.5*randn(size(t));
```

The filter design is an FIR lowpass filter with order equal to 20 and a cutoff frequency of 150 Hz. Use a Kaiser window with length one sample greater than the filter order and  $\beta=3$ . See `kaiser` for details on the Kaiser window.

Use `fir1` to design the filter. `fir1` requires normalized frequencies in the interval  $[0,1]$ , where 1 is  $(1)\pi$  radians/sample. To use `fir1`, you must convert all frequency specifications to normalized frequencies.

Design the filter and view the filter’s magnitude response.

```
fc = 150;  
Wn = (2/Fs)*fc;
```



```
b = fir1(20,Wn,'low',kaiser(21,3));  
fvtool(b,1,'Fs',Fs);
```

Apply the filter to the signal and plot the result for the first ten periods of the 100-Hz sinusoid.

```
y = filter(b,1,x);  
plot(t(1:100),x(1:100),'k');  
hold on;  
plot(t(1:100),y(1:100),'r','linewidth',2);  
legend('Original Signal','Filtered Data','Location','SouthEast');  
xlabel('Seconds'); ylabel('Amplitude');
```

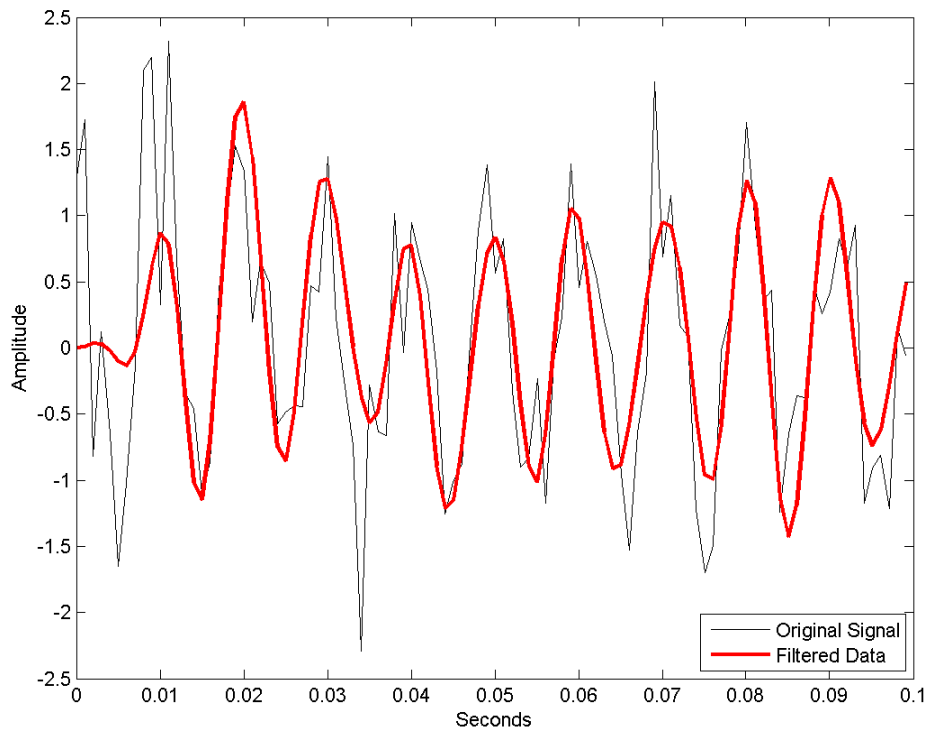

Design the same filter using `fdesign.lowpass`.

Set the filter specifications using the 'N,Fc' specification string. With `fdesign.lowpass`, you can specify your filter design in Hz.

```
Fs = 1000;  
d = fdesign.lowpass('N,Fc',20,150,Fs);  
Hd = design(d,'window','Window',kaiser(21,3));
```

Filter the data and plot the result.

```
y1 = filter(Hd,x);  
plot(t(1:100),x(1:100),'k');  
hold on;  
plot(t(1:100),y1(1:100),'r','linewidth',2);  
legend('Original Signal','Filtered Data','Location','SouthEast');  
xlabel('Seconds'); ylabel('Amplitude');
```

Design and implement a lowpass FIR filter using the window method with the interactive tool `fdatool`.

Start `FDATool` by entering

```
fdatool
```

at the command line.

Set the **Response Type** to **Lowpass**. Set the **Design Method** to **FIR** and select the **Window** method.

Under **Filter Order**, select **Specify order**. Set the order to 20.

Under **Frequency Specifications**. Set **Units** to **Hz**, **Fs**: to 1000, and **Fc**: to 150.

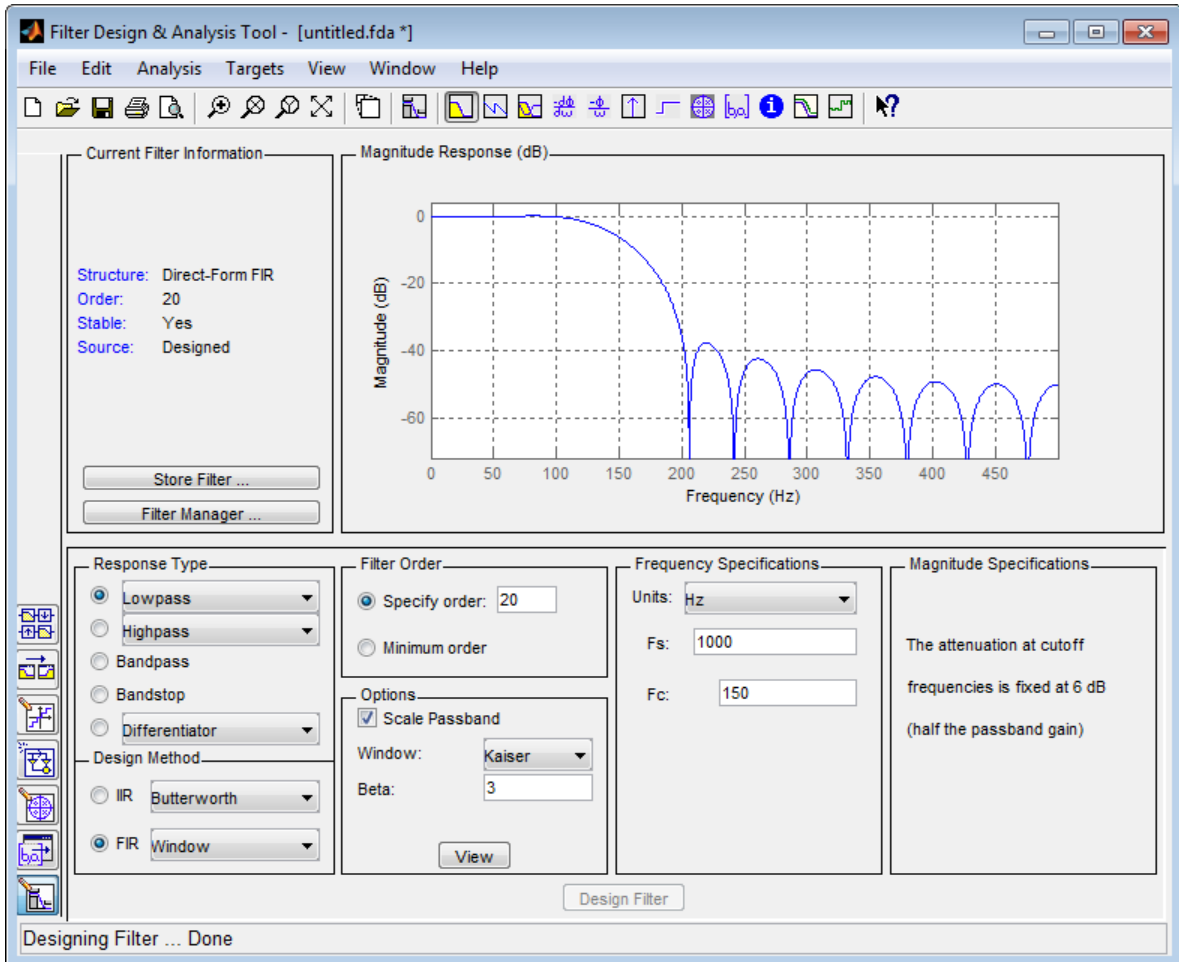

Click **Design Filter**.

Select **File** → **Export...** to export your FIR filter to the MATLAB workspace as coefficients or a filter object. In this example, export the filter as an object. Specify the variable name as Hd1.

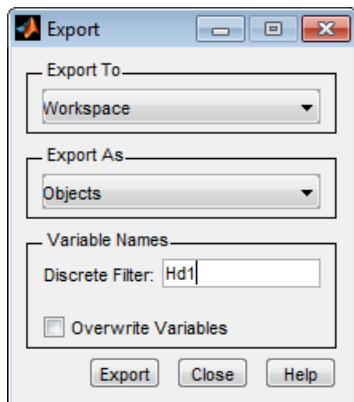

Click **Export**.

Filter the input signal in the command window with the exported filter object. Plot the result for the first ten periods of the 100-Hz sinusoid.

```
y2 = filter(Hd1,x);  
plot(t(1:100),x(1:100),'k');  
hold on;  
plot(t(1:100),y1(1:100),'r','linewidth',2);  
legend('Original Signal','Filtered Data','Location','SouthEast');  
xlabel('Seconds'); ylabel('Amplitude');
```

Select **File** → **Generate MATLAB Code** to generate a MATLAB function to create a filter object using your specifications.

You can also use the interactive tool `filterbuilder` to design your filter.

### Bandpass Filters – Minimum-Order FIR and IIR Systems

This example shows you how to design a bandpass filter and filter data with minimum-order FIR equiripple and IIR Butterworth filters. The example uses `fdesign.bandpass` and the interactive tool `fdatool`.

You can model many real-world signals as a superposition of oscillating components, a low-frequency trend, and additive noise. For example,

economic data often contain oscillations, which represent cycles superimposed on a slowly varying upward or downward trend. In addition, there is an additive noise component, which is a combination of measurement error and the inherent random fluctuations in the process.

In these examples, assume you sample some process every day for 1 year. Assume the process has oscillations on approximately one-week and one-month scales. In addition, there is a low-frequency upward trend in the data and additive  $N(0,1/4)$  white Gaussian noise.

Create the signal as a superposition of two sine waves with frequencies of 1/7 and 1/30 cycles/day. Add a low-frequency increasing trend term and  $N(0,1/4)$  white Gaussian noise. Set the random number generator to the default state for reproducible results. The data is sampled at 1 sample/day. Plot the resulting signal and the power spectral density (PSD) estimate.

```
rng default;
Fs =1;
n = 1:365;
x = cos(2*pi*(1/7)*n)+cos(2*pi*(1/30)*n-pi/4);
trend = 3*sin(2*pi*(1/1480)*n);
y = x+trend+0.5*randn(size(n));
subplot(211);
plot(n,y); xlabel('Days'); set(gca,'xlim',[1 365]);
grid on;
subplot(212);
psdest = psd(spectrum.periodogram,y,'Fs',Fs);
plot(psdest.Frequencies,10*log10(psdest.Data));
xlabel('Cycles/day'); ylabel('dB'); grid on;
```

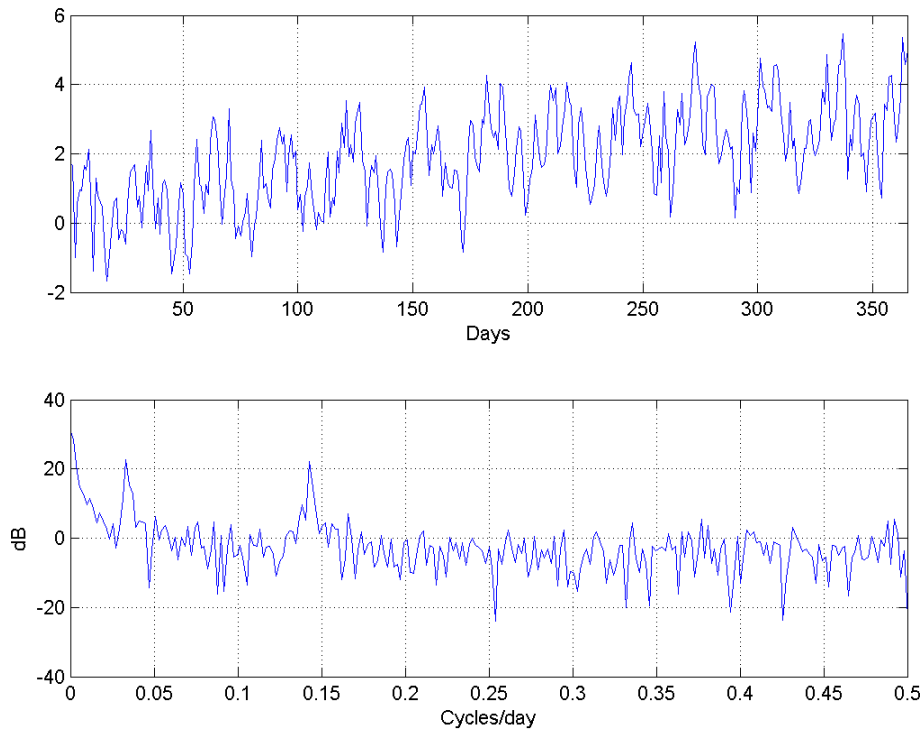

The low-frequency trend appears in the power spectral density estimate as increased low-frequency power. The low-frequency power appears approximately 10 dB above the oscillation at  $1/30$  cycles/day. Use this information in the specifications for the filter stopbands.

Design minimum-order FIR equiripple and IIR Butterworth filters with the following specifications: passband from  $[1/40, 1/4]$  cycles/day and stopbands from  $[0, 1/60]$  and  $[1/4, 1/2]$  cycles/day. Set both stopband attenuations to 10 dB and the passband ripple tolerance to 1 dB.

```
d = fdesign.bandpass('Fst1,Fp1,Fp2,Fst2,Ast1,Ap,Ast2',...
    1/60,1/40,1/4,1/2,10,1,10,1);
Hd1 = design(d,'equiripple');
Hd2 = design(d,'butter');
```

Compare the order of the FIR and IIR filters and the unwrapped phase responses.

```
fprintf('The order of the FIR filter is %d\n',length(Hd1.Numerator)-1);  
[b,a] = sos2tf(Hd2.sosMatrix,Hd2.ScaleValues);  
fprintf('The order of the IIR filter is %d\n',length(max(b,a))-1);  
[phifir,w] = phasez(Hd1,[],1);  
[phiir,w] = phasez(Hd2,[],1);  
plot(w,unwrap(phifir),'b'); hold on;  
plot(w,unwrap(phiir),'r'); grid on;  
xlabel('Cycles/Day'); ylabel('Radians');  
legend('FIR Equiripple Filter','IIR Butterworth Filter');
```

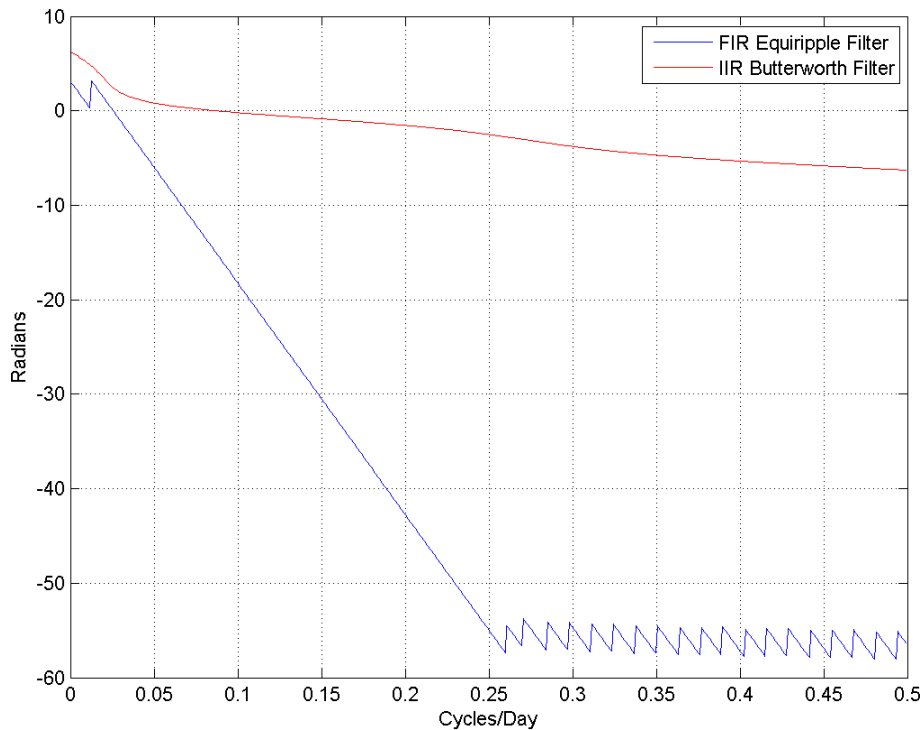

The IIR filter has a much lower order than the FIR filter. However, the FIR filter has a linear phase response over the passband, while the IIR filter does not. The FIR filter delays all frequencies in the filter passband equally, while the IIR filter does not.

Additionally, the rate of change of the phase per unit of frequency is greater in the FIR filter than in the IIR filter.

Design a lowpass FIR equiripple filter for comparison. The lowpass filter specifications are: passband  $[0, 1/4]$  cycles/day, stopband attenuation equal to 10 dB, and the passband ripple tolerance set to 1 dB.

```
dlow = fdesign.lowpass('Fp,Fst,Ap,Ast',1/4,1/2,1,10,1);  
Hdlow = design(dlow,'equiripple');
```

Filter the data with the bandpass and lowpass filters.

```
yfir = filter(Hd1,y);  
yiir = filter(Hd2,y);  
ylow = filter(Hdlow,y);
```

Plot the PSD estimate of the bandpass IIR filter output. You can replace `yiir` with `yfir` in the following code to view the PSD estimate of the FIR bandpass filter output.

```
psdest = psd(spectrum.periodogram,yiir,'Fs',Fs);  
plot(psdest.Frequencies,10*log10(psdest.Data));  
xlabel('Cycles/day'); ylabel('dB'); grid on;
```



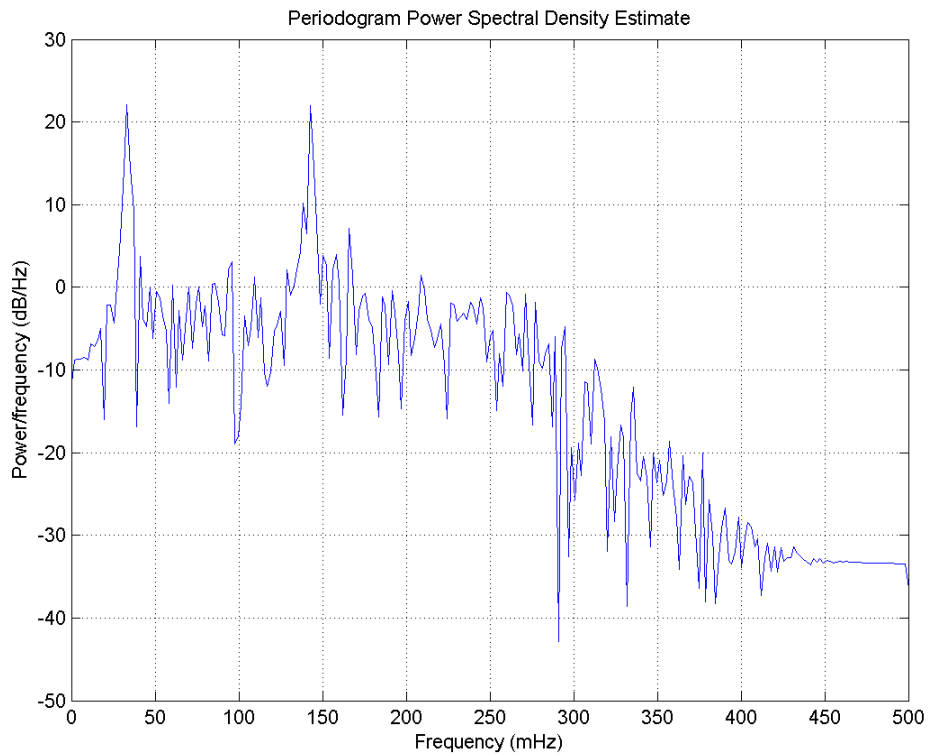

The PSD estimate shows the bandpass filter attenuates the low-frequency trend and high-frequency noise.

Plot the first 120 days of FIR and IIR filter output.

```
plot(n(1:120),yfir(1:120),'b');
hold on;
plot(n(1:120),yiir(1:120),'r');
xlabel('Days'); axis([1 120 -2.8 2.8]);
legend('FIR bandpass filter output','IIR bandpass filter output',...
      'Location','SouthEast');
```

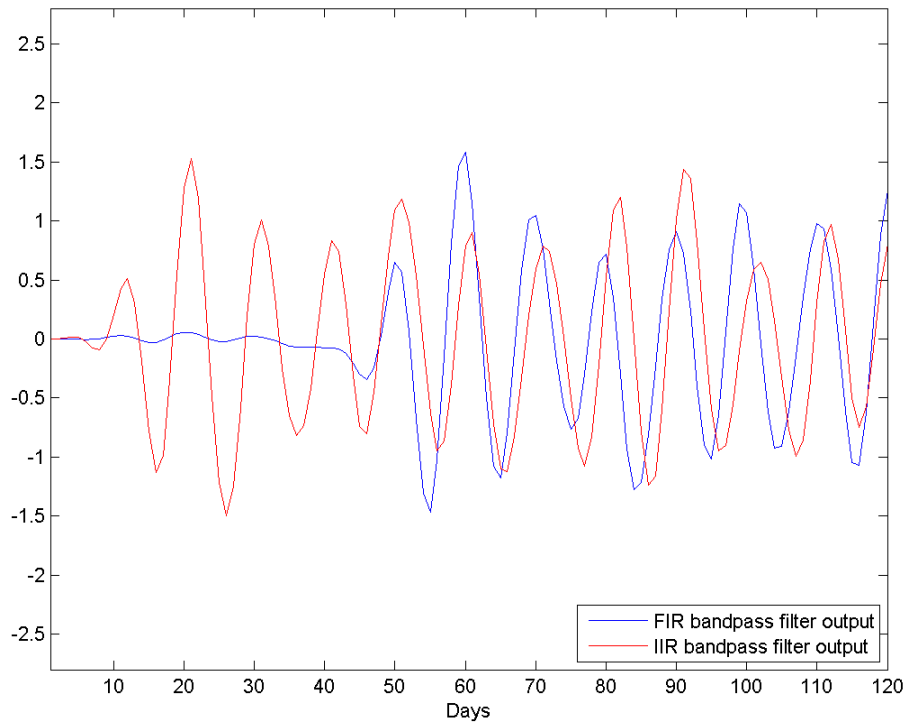

The increased phase delay in the FIR filter is evident in the filter output.

Plot the lowpass FIR filter output superimposed on the superposition of the 7-day and 30-day cycles for comparison.

```
plot(n,x,'k');  
hold on;  
plot(n,ylow,'r'); set(gca,'xlim',[1 365]);  
legend('7-day and 30-day cycles','FIR lowpass filter output',...  
      'Location','NorthWest');  
xlabel('Days');
```

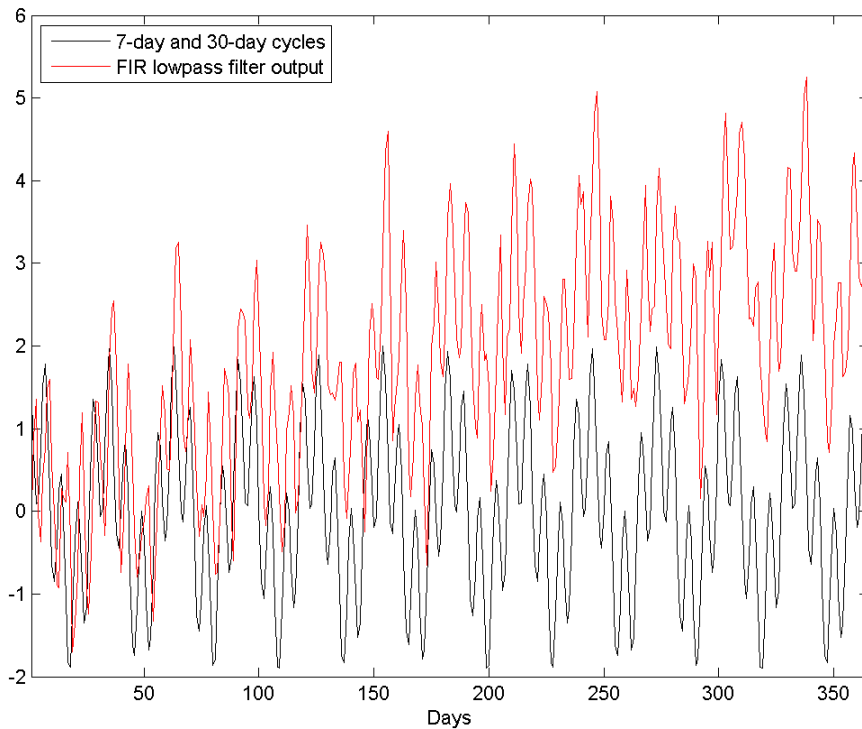

You can see in the preceding plot that the low-frequency trend is evident in the lowpass filter output. While the lowpass filter preserves the 7-day and 30-day cycles, the bandpass filters perform better in this example because the bandpass filters also remove the low-frequency trend.

Design and implement the bandpass Butterworth (IIR) filter with the interactive tool `fdatool`.

Start `FDATool` by entering

```
fdatool
```

at the command line.

Set the **Response Type** to **Bandpass**. Set the **Design Method** to **IIR** and select the **Butterworth** design.

Under **Filter Order**, select **Minimum order**.

Under **Frequency Specifications**. Set **Units** to **Hz**, **Fs**: to 1, **Fstop1**: to 1/60, **Fpass1**: to 1/40, **Fpass2**: to 1/4, and **Fstop2**: to 1/2. Under **Magnitude Specifications**, set **Astop1**: and **Astop2**: to 10 and **Apass**: to 1.

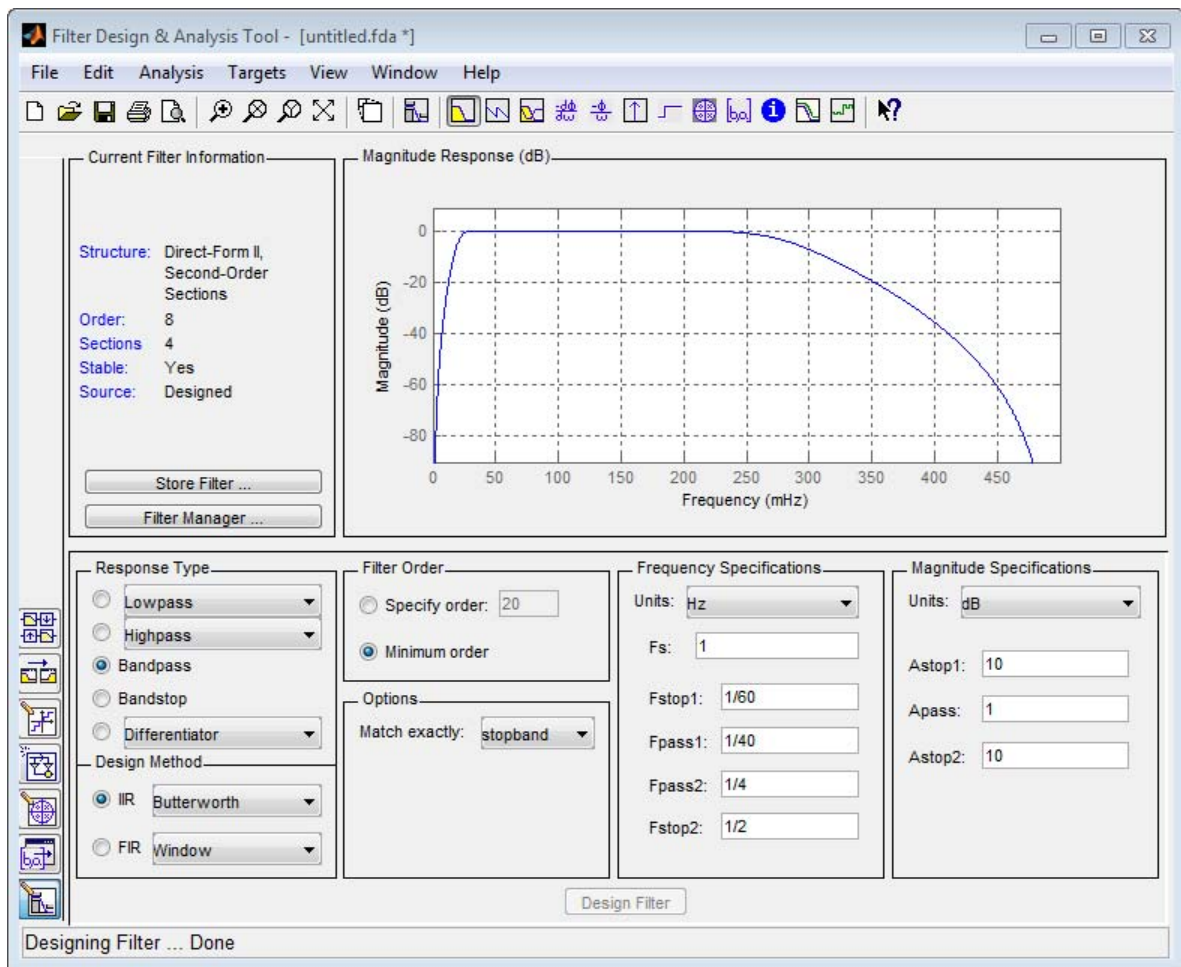

Click **Design Filter**.

Select **File** → **Export...** to export your IIR filter to the MATLAB workspace as coefficients or a filter object. In this example, export the filter as an object. Specify the variable name as Hd3.

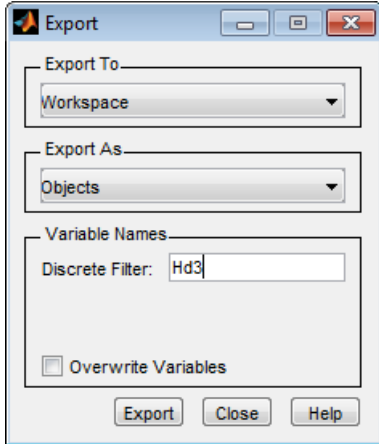

Click **Export**.

Filter the input signal in the command window with the exported filter object.

```
yfilt = filter(Hd3,x);
```

Select **File** → **Generate MATLAB Code** to generate a MATLAB function to create a filter object using your specifications.

You can also use the interactive tool `filterbuilder` to design your filter.

## Zero-Phase Filtering

These examples show you how to perform zero-phase filtering. The signal and filters are described in “Lowpass FIR Filter — Window Method” on page 2-52 and “Bandpass Filters — Minimum-Order FIR and IIR Systems” on page 2-56.

Repeat the signal generation and lowpass filter design with `fir1` and `fdesign.lowpass`. You do not have to execute the following code if you already have these variables in your workspace.

```
rng default;
Fs = 1000;
t = linspace(0,1,Fs);
x = cos(2*pi*100*t)+0.5*randn(size(t));
% Using fir1
fc = 150;
Wn = (2/Fs)*fc;
b = fir1(20,Wn,'low',kaiser(21,3));
% Using fdesign.lowpass
d = fdesign.lowpass('N,Fc',20,150,Fs);
Hd = design(d,'window','Window',kaiser(21,3));
```

Filter the data using `filter`. Plot the first 100 points of the filter output along with a superimposed sinusoid with the same amplitude and initial phase as the input signal.

```
yout = filter(Hd,x);
xin = cos(2*pi*100*t);
plot(t(1:100),xin(1:100),'k');
hold on; grid on;
plot(t(1:100),yout(1:100),'r','linewidth',2);
xlabel('Seconds'); ylabel('Amplitude');
legend('Input Sine Wave','Filtered Data',...
       'Location','NorthEast');
```

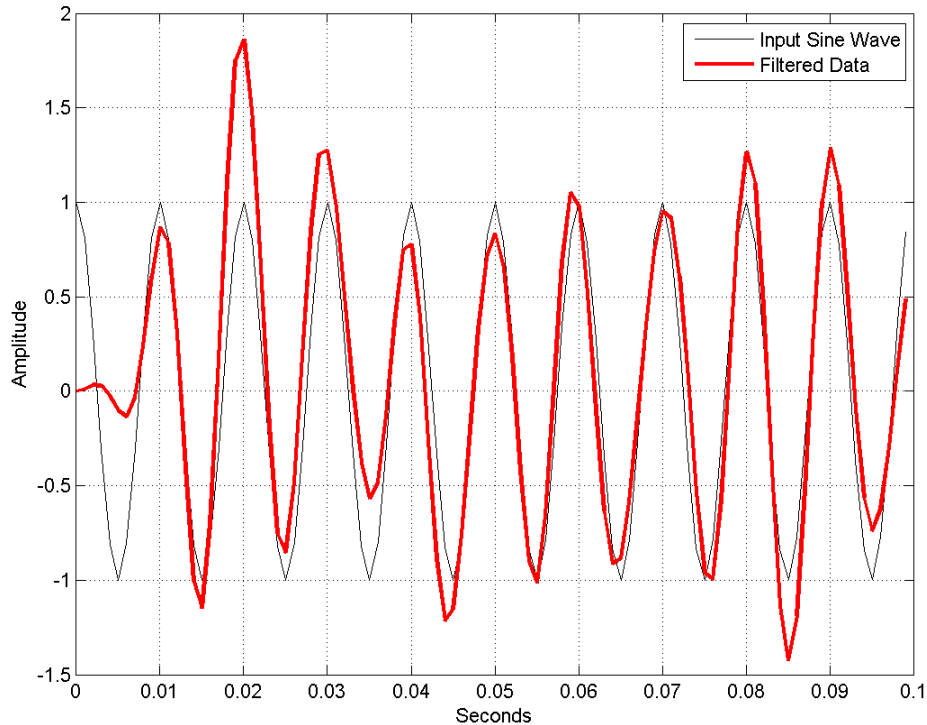

Looking at the initial 0.01 seconds of the filtered data, you see that the output is delayed with respect to the input. The delay appears to be approximately 0.01 seconds, which is almost 1/2 the length of the FIR filter in samples ( $10 \times 0.001$ ).

This delay is due to the filter's phase response. The FIR filter in these examples is a type I linear-phase filter. The group delay of the filter is 10 samples.

Plot the group delay using `fvtool`.

```
fvtool(Hd, 'analysis', 'grpdelay');
```

In many applications, phase distortion is acceptable. This is particularly true when phase response is linear. In other applications, it is desirable to have a filter with a zero-phase response. A zero-phase response is not technically possible in a noncausal filter. However, you can implement zero-phase filtering using a causal filter with `filtfilt`. `filtfilt` does not accept filter objects as input arguments, but you can still use filter objects with `filtfilt` by extracting the filter coefficients from the object.

Filter the input signal using the coefficients in the filter object. Plot the responses to compare the filter outputs obtained with `filter` and `filtfilt`.

```
yzp = filtfilt(Hd.Numerator,1,x);
% or yzp = filtfilt(b,1,x);
plot(t(1:100),xin(1:100),'k');
hold on;
plot(t(1:100),yout(1:100),'r','linewidth',2);
plot(t(1:100),yzp(1:100),'b','linewidth',2);
xlabel('Seconds'); ylabel('Amplitude');
legend('100-Hz Sine Wave','Filtered Signal','Zero-phase Filtering',...
      'Location','NorthEast');
```



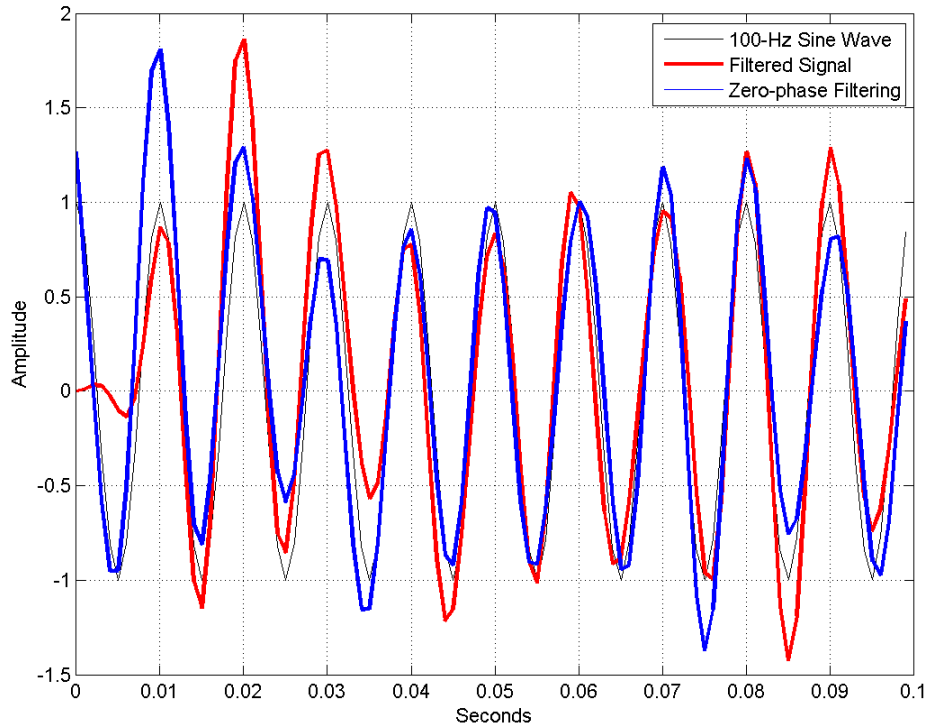

In the preceding figure, you can see that the output of `filtfilt` does not exhibit the delay due to the phase response of the FIR filter.

The IIR bandpass filter designed in “Bandpass Filters — Minimum-Order FIR and IIR Systems” on page 2-56 is a biquad filter. Stated equivalently, the IIR filter is in the form of cascaded second-order sections. To implement zero-phase filtering with a discrete-time biquad filter, you must input the matrix of second-order sections and the gain values for each of those sections into `filtfilt`.

Zero phase filter the data in “Bandpass Filters — Minimum-Order FIR and IIR Systems” on page 2-56 with the IIR bandpass filter. For convenience, the

code to generate the signal and filter is repeated. You do not have to execute this code if you already have these variables in your workspace.

Generate the data.

```
rng default;
Fs = 1;
n = 1:365;
x = cos(2*pi*(1/7)*n)+cos(2*pi*(1/30)*n-pi/4);
trend = 3*sin(2*pi*(1/1480)*n);
y = x+trend+0.5*randn(size(n));
```

Specify and design the filter.

```
d = fdesign.bandpass('Fst1,Fp1,Fp2,Fst2,Ast1,Ap,Ast2',...
    1/60,1/40,1/4,1/2,10,1,10,1);
Hd2 = design(d,'butter');
```

Use `filtfilt` to zero-phase filter the input. Input the matrix of second-order sections and gain (scale) values along with your signal.

```
yzpiir = filtfilt(Hd2.sosMatrix,Hd2.ScaleValues,y);
```

## Selected Bibliography

- [1] Karam, L.J., and J.H. McClellan. "Complex Chebyshev Approximation for FIR Filter Design." *IEEE Trans. on Circuits and Systems II*. March 1995.
  
- [2] Selesnick, I.W., and C.S. Burrus. "Generalized Digital Butterworth Filter Design." *Proceedings of the IEEE Int. Conf. Acoust., Speech, Signal Processing*. Vol. 3 (May 1996).
  
- [3] Selesnick, I.W., M. Lang, and C.S. Burrus. "Constrained Least Square Design of FIR Filters without Specified Transition Bands." *Proceedings of the IEEE Int. Conf. Acoust., Speech, Signal Processing*. Vol. 2 (May 1995). Pgs. 1260-1263.



# Designing a Filter in Fdesign — Process Overview

---

## Process Flow Diagram and Filter Design Methodology

In this section...
“Exploring the Process Flow Diagram” on page 3-2
“Selecting a Response” on page 3-4
“Selecting a Specification” on page 3-4
“Selecting an Algorithm” on page 3-6
“Customizing the Algorithm” on page 3-8
“Designing the Filter” on page 3-8
“Design Analysis” on page 3-9
“Realize or Apply the Filter to Input Data” on page 3-10

---

**Note** You must minimally have the Signal Processing Toolbox installed to use `fdesign` and `design`. Some of the features described below may be unavailable if your installation does not additionally include the DSP System Toolbox™ license. The DSP System Toolbox significantly expands the functionality available for the specification, design, and analysis of filters. You can verify the presence of both toolboxes by typing `ver` at the command prompt.

---

### Exploring the Process Flow Diagram

The process flow diagram shown in the following figure lists the steps and shows the order of the filter design process.

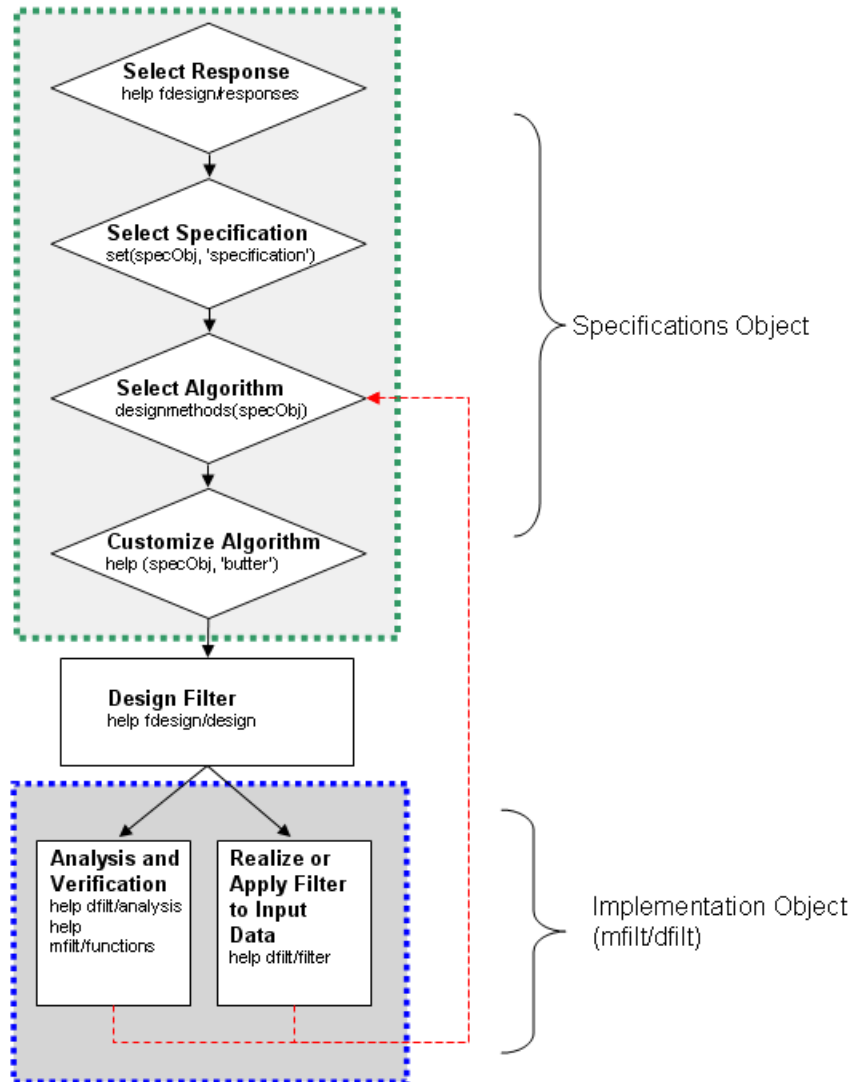

The first four steps of the filter design process relate to the filter Specifications Object, while the last two steps involve the filter Implementation Object. Both of these objects are discussed in more detail in the following sections. Step 5 - the design of the filter, is the transition step from the filter Specifications Object to the Implementation object. The analysis and verification step is

completely optional. It provides methods for the filter designer to ensure that the filter complies with all design criteria. Depending on the results of this verification, you can loop back to steps 3 and 4, to either choose a different algorithm, or to customize the current one. You may also wish to go back to steps 3 or 4 after you filter the input data with the designed filter (step 7), and find that you wish to tweak the filter or change it further.

The diagram shows the help command for each step. Enter the help line at the MATLAB command prompt to receive instructions and further documentation links for the particular step. Not all of the steps have to be executed explicitly. For example, you could go from step 1 directly to step 5, and the interim three steps are done for you by the software.

The following are the details for each of the steps shown above.

## Selecting a Response

If you type:

```
help fdesign/responses
```

at the MATLAB command prompt, you see a list of all available filter responses. The responses marked with an asterisk require the DSP System Toolbox.

You must select a response to initiate the filter. In this example, a bandpass filter Specifications Object is created by typing the following:

```
d = fdesign.bandpass
```

## Selecting a Specification

A *specification* is an array of design parameters for a given filter. The specification is a property of the Specifications Object.

---

**Note** A specification is not the same as the Specifications Object. A Specifications Object contains a specification as one of its properties.

---



When you select a filter response, there are a number of different specifications available. Each one contains a different combination of design parameters. After you create a filter Specifications Object, you can query the available specifications for that response. Specifications marked with an asterisk require the DSP System Toolbox.

```
>> d = fdesign.bandpass; % step 1 - choose the response
>> set (d, 'specification')
```

```
ans =
```

```
'Fst1,Fp1,Fp2,Fst2,Ast1,Ap,Ast2'
'N,F3dB1,F3dB2'
'N,F3dB1,F3dB2,Ap'
'N,F3dB1,F3dB2,Ast'
'N,F3dB1,F3dB2,Ast1,Ap,Ast2'
'N,F3dB1,F3dB2,BWp'
'N,F3dB1,F3dB2,BWst'
'N,Fc1,Fc2'
'N,Fp1,Fp2,Ap'
'N,Fp1,Fp2,Ast1,Ap,Ast2'
'N,Fst1,Fp1,Fp2,Fst2'
'N,Fst1,Fp1,Fp2,Fst2,Ap'
'N,Fst1,Fst2,Ast'
'Nb,Na,Fst1,Fp1,Fp2,Fst2'
```

```
>> d=fdesign.arbmag;
>> set(d,'specification')
```

```
ans =
```

```
'N,F,A'
'N,B,F,A'
```

The set command can be used to select one of the available specifications as follows:

```
>> d = fdesign.lowpass; % step 1
>> % step 2: get a list of available specifications
>> set (d, 'specification')
```

```
ans =  
  
    'Fp,Fst,Ap,Ast'  
    'N,F3dB'  
    'N,F3dB,Ap'  
    'N,F3dB,Ap,Ast'  
    'N,F3dB,Ast'  
    'N,F3dB,Fst'  
    'N,Fc'  
    'N,Fc,Ap,Ast'  
    'N,Fp,Ap'  
    'N,Fp,Ap,Ast'  
    'N,Fp,F3dB'  
    'N,Fp,Fst'  
    'N,Fp,Fst,Ap'  
    'N,Fp,Fst,Ast'  
    'N,Fst,Ap,Ast'  
    'N,Fst,Ast'  
    'Nb,Na,Fp,Fst'  
  
>> %step 2: set the required specification  
>> set (d, 'specification', 'N,Fc')
```

If you do not perform this step explicitly, `fdesign` returns the default specification for the response you chose in “Select a Response” on page 4-3, and provides default values for all design parameters included in the specification.

## Selecting an Algorithm

The availability of algorithms depends the chosen filter response, the design parameters, and the availability of the DSP System Toolbox. In other words, for the same lowpass filter, changing the specification string also changes the available algorithms. In the following example, for a lowpass filter and a specification of 'N, Fc', only one algorithm is available—window.

```
>> %step 2: set the required specification  
>> set (d, 'specification', 'N,Fc')  
>> designmethods (d) %step3: get available algorithms
```

Design Methods for class `fdesign.lowpass (N,Fc)`:

```
window
```

However, for a specification of '`Fp,Fst,Ap,Ast`', a number of algorithms are available. If the user has only the Signal Processing Toolbox installed, the following algorithms are available:

```
>>set (d, 'specification', 'Fp,Fst,Ap,Ast')  
>>designmethods(d)
```

Design Methods for class `fdesign.lowpass (Fp,Fst,Ap,Ast)`:

```
butter  
cheby1  
cheby2  
ellip  
equiripple  
kaiserwin
```

If the user additionally has the DSP System Toolbox installed, the number of available algorithms for this response and specification string increases:

```
>>set(d,'specification','Fp,Fst,Ap,Ast')  
>>designmethods(d)
```

Design Methods for class `fdesign.lowpass (Fp,Fst,Ap,Ast)`:

```
butter  
cheby1  
cheby2  
ellip  
equiripple  
ifir  
kaiserwin
```

`multistage`

The user chooses a particular algorithm and implements the filter with the `design` function.

```
>> Hd=design(d, 'butter');
```

The preceding code actually creates the filter, where `Hd` is the filter Implementation Object. This concept is discussed further in the next step.

If you do not perform this step explicitly, `design` automatically selects the optimum algorithm for the chosen response and specification.

## Customizing the Algorithm

The customization options available for any given algorithm depend not only on the algorithm itself, selected in “Selecting an Algorithm” on page 3-6, but also on the specification selected in “Selecting a Specification” on page 3-4. To explore all the available options, type the following at the MATLAB command prompt:

```
help (d, 'algorithm-name')
```

where `d` is the Filter Specification Object, and `algorithm-name` is the name of the algorithm in single quotes, such as `'butter'` or `'cheby1'`.

The application of these customization options takes place while “Designing the Filter” on page 3-8, because these options are the properties of the filter Implementation Object, not the Specification Object.

If you do not perform this step explicitly, the optimum algorithm structure is selected.

## Designing the Filter

This next task introduces a new object, the Filter Object, or `dfilt`. To create a filter, use the `design` command:

```
>> % design filter w/o specifying the algorithm  
>> Hd = design(d);
```

where Hd is the Filter Object and d is the Specifications Object. This code creates a filter without specifying the algorithm. When the algorithm is not specified, the software selects the best available one.

To apply the algorithm chosen in “Selecting an Algorithm” on page 3-6, use the same `design` command, but specify the Butterworth algorithm as follows:

```
>> Hd = design(d, 'butter');
```

where Hd is the new Filter Object, and d is the Specifications Object.

To obtain help and see all the available options, type:

```
>> help fdesign/design
```

This help command describes not only the options for the `design` command itself, but also options that pertain to the method or the algorithm. If you are customizing the algorithm, you apply these options in this step. In the following example, you design a bandpass filter, and then modify the filter structure:

```
>> Hd = design(d, 'butter', 'filterstructure', 'df2sos')
```

```
f =
```

```
    FilterStructure: 'Direct-Form II, Second-Order Sections'
           Arithmetic: 'double'
           sosMatrix: [7x6 double]
           ScaleValues: [8x1 double]
    PersistentMemory: false
```

The filter design step, just like the first task of choosing a response, must be performed explicitly. A Filter Object is created only when `design` is called.

## Design Analysis

After the filter is designed you may wish to analyze it to determine if the filter satisfies the design criteria. Filter analysis is broken into three main sections:

- Frequency domain analysis — Includes the magnitude response, group delay, and pole-zero plots.

- Time domain analysis — Includes impulse and step response
- Implementation analysis — Includes quantization noise and cost

To display help for analysis of a discrete-time filter, type:

```
>> help dfilt/analysis
```

To display help for analysis of a multirate filter, type:

```
>> help mfilt/functions
```

To display help for analysis of a farrow filter, type:

```
>> help farrow/functions
```

To analyze your filter, you must explicitly perform this step.

## Realize or Apply the Filter to Input Data

After the filter is designed and optimized, it can be used to filter actual input data. The basic filter command takes input data  $x$ , filters it through the Filter Object, and produces output  $y$ :

```
>> y = filter (FilterObj, x)
```

This step is never automatically performed for you. To filter your data, you must explicitly execute this step. To understand how the filtering commands work, type:

```
>> help dfilt/filter
```

---

**Note** If you have Simulink®, you have the option of exporting this filter to a Simulink block using the `realizemdl` command. To get help on this command, type:

```
>> help realizemdl
```

---

# Designing a Filter in the Filterbuilder GUI

---

- “Filterbuilder Design Process” on page 4-2
- “Designing a FIR Filter Using filterbuilder” on page 4-10

# Filterbuilder Design Process

In this section...
“Introduction to Filterbuilder” on page 4-2
“Design a Filter Using Filterbuilder” on page 4-2
“Select a Response” on page 4-3
“Select a Specification” on page 4-5
“Select an Algorithm” on page 4-5
“Customize the Algorithm” on page 4-6
“Analyze the Design” on page 4-8
“Realize or Apply the Filter to Input Data” on page 4-8

## Introduction to Filterbuilder

The `filterbuilder` function provides a graphical interface to the `fdesign` object-object oriented filter design paradigm and is intended to reduce development time during the filter design process. `filterbuilder` uses a specification-centered approach to find the best algorithm for the desired response.

---

**Note** `filterbuilder` requires the Signal Processing Toolbox. The functionality of `filterbuilder` is greatly expanded by the DSP System Toolbox. Many of the features described or displayed below are only available if the DSP System Toolbox is installed. You may verify your installation by typing `ver` at the command prompt.

---

## Design a Filter Using Filterbuilder

The basic workflow in using `filterbuilder` is to choose the constraints and specifications of the filter, and to use those as a starting point in the design. Postponing the choice of algorithm for the filter allows the best design method to be determined automatically, based upon the desired performance criteria. The following are the details of each of the steps for designing a filter with `filterbuilder`.



## Select a Response

When you open the filterbuilder tool by typing:

```
filterbuilder
```

at the MATLAB command prompt, the **Response Selection** dialog box appears, listing all possible filter responses available in DSP System Toolbox software.

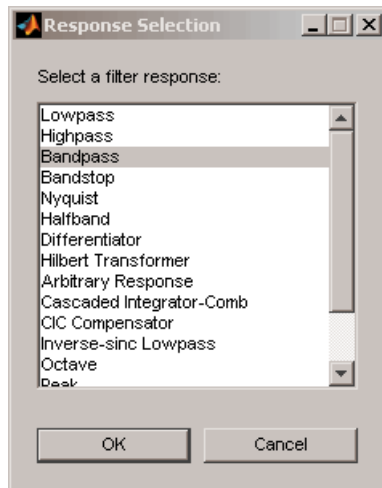

---

**Note** This step cannot be skipped because it is not automatically completed for you by the software. You must select a response to initiate the filter design process.

---

After you choose a response, say bandpass, you start the design of the Specifications Object, and the Bandpass Design dialog box appears. This dialog box contains a **Main** pane, a **Data Types** pane and a **Code Generation** pane. The specifications of your filter are generally set in the **Main** pane of the dialog box.

The **Data Types** pane provides settings for precision and data types, and the **Code Generation** pane contains options for various implementations of the completed filter design.

For the initial design of your filter, you will mostly use the **Main** pane.

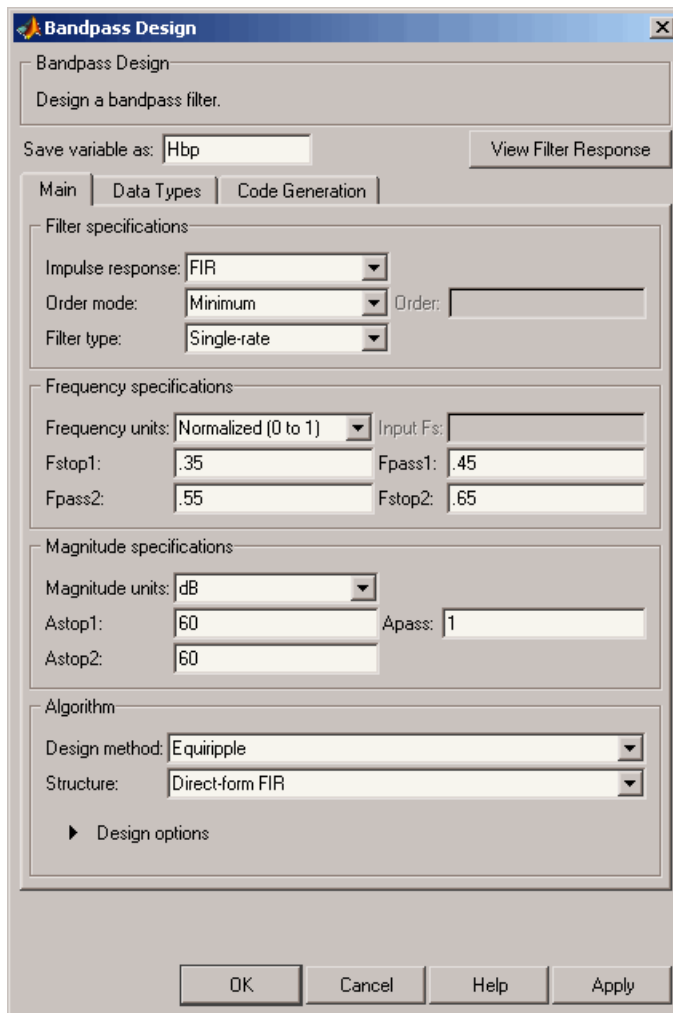

The **Bandpass Design** dialog box contains all the parameters you need to determine the specifications of a bandpass filter. The parameters listed in the **Main** pane depend upon the type of filter you are designing. However, no matter what type of filter you have chosen in the **Response Selection**

dialog box, the filter design dialog box contains the **Main**, **Data Types**, and **Code Generation** panes.

## Select a Specification

To choose the specification for the bandpass filter, you can begin by selecting an **Impulse Response**, **Order Mode**, and **Filter Type** in the **Filter Specifications** frame of the **Main Pane**. You can further specify the response of your filter by setting frequency and magnitude specifications in the appropriate frames on the **Main Pane**.

---

**Note** **Frequency**, **Magnitude**, and **Algorithm** specifications are interdependent and may change based upon your **Filter Specifications** selections. When choosing specifications for your filter, select your Filter Specifications first and work your way down the dialog box- this approach ensures that the best settings for dependent specifications display as available in the dialog box.

---

## Select an Algorithm

The algorithms available for your filter depend upon the filter response and design parameters you have selected in the previous steps. For example, in the case of a bandpass filter, if the impulse response selected is IIR and the **Order Mode** field is set to **Minimum**, the design methods available are **Butterworth**, **Chebyshev type I or II**, or **Elliptic**, whereas if the **Order Mode** field is set to **Specify**, the design method available is **IIR least p-norm**.

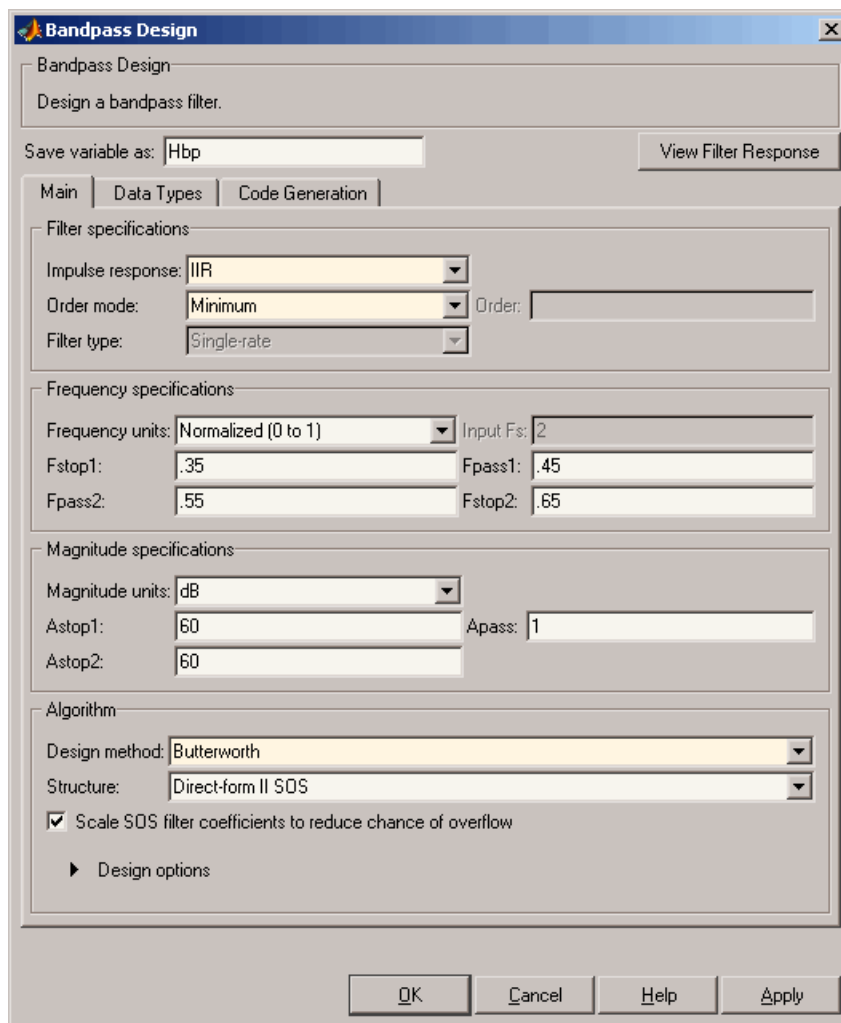

### Customize the Algorithm

By expanding the **Design options** section of the **Algorithm** frame, you can further customize the algorithm specified. The options available will depend upon the algorithm and settings that have already been selected in the dialog box. In the case of a bandpass IIR filter using the Butterworth

method, design options such as **Match Exactly** are available, as shown in the following figure.

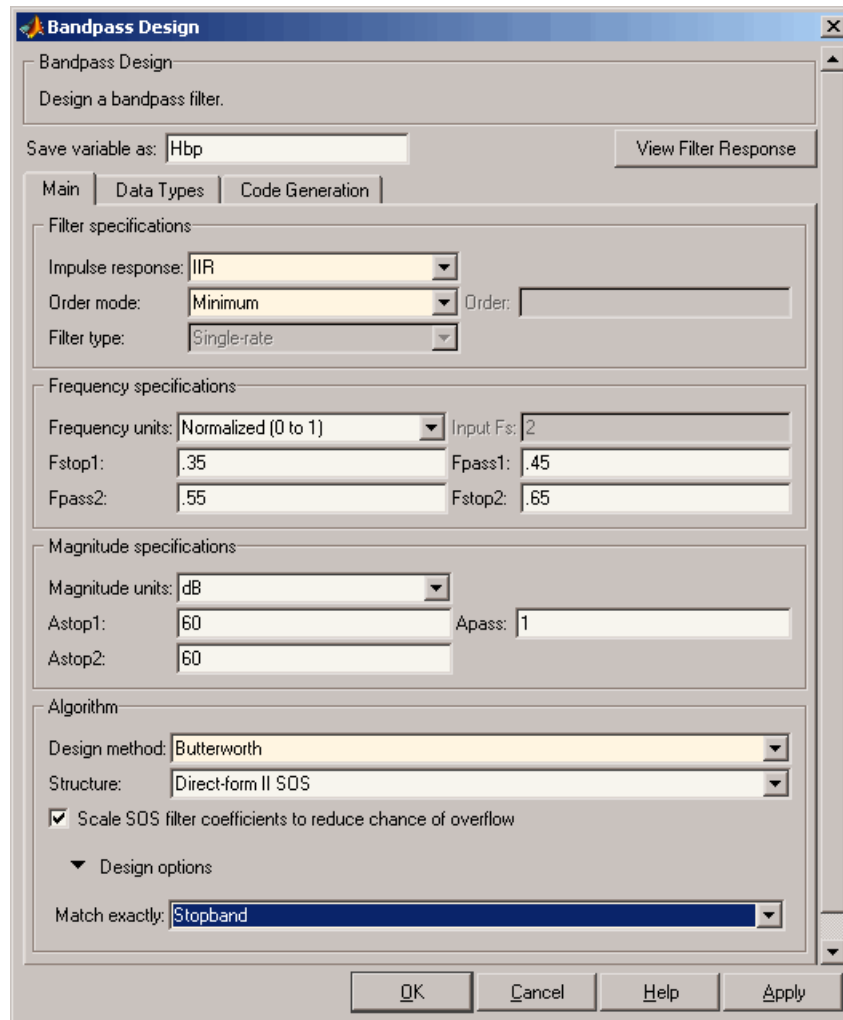

### Analyze the Design

To analyze the filter response, click on the View Filter Response button. The Filter Visualization Tool opens displaying the magnitude plot of the filter response.

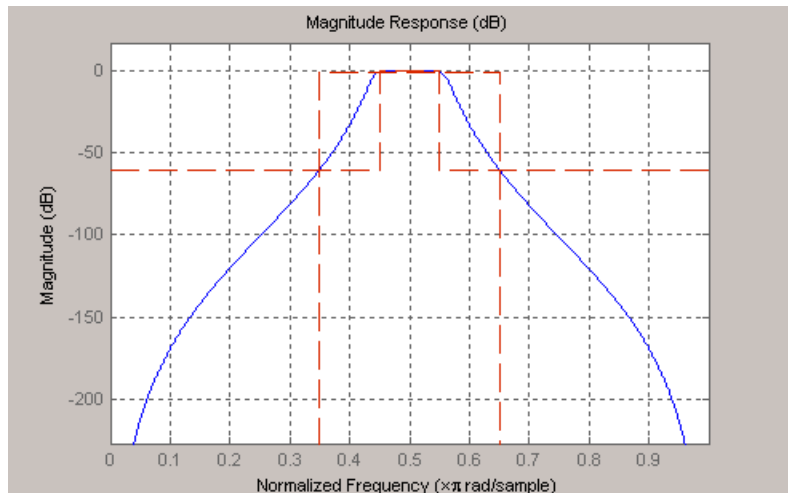

### Realize or Apply the Filter to Input Data

When you have achieved the desired filter response through design iterations and analysis using the **Filter Visualization Tool**, apply the filter to the input data. Again, this step is never automatically performed for you by the software. To filter your data, you must explicitly execute this step. In the **Filter Visualization Tool**, click OK and DSP System Toolbox software creates the filter object with the name specified in the **Save variable as** field and exports it to the MATLAB workspace.

The filter is then ready to be used to filter actual input data. The basic filter command takes input data  $x$ , filters it through the Filter Object, and produces output  $y$ :

```
>> y = filter (FilterObj, x)
```

To understand how the filtering commands work, type:

```
>> help dfilt/filter
```

---

**Tip** If you have Simulink, you have the option of exporting this filter to a Simulink block using the `realizemdl` command. To get help on this command, type:

```
>> help realizemdl
```

---

# Designing a FIR Filter Using filterbuilder

## FIR Filter Design

### Example – Using Filterbuilder to Design a Finite Impulse Response (FIR) Filter

To design a lowpass FIR filter using `filterbuilder`:

- 1 Open the Filterbuilder GUI by typing the following at the MATLAB prompt:

```
filterbuilder
```

The **Response Selection** dialog box appears. In this dialog box, you can select from a list of filter response types. Select Lowpass in the list box.

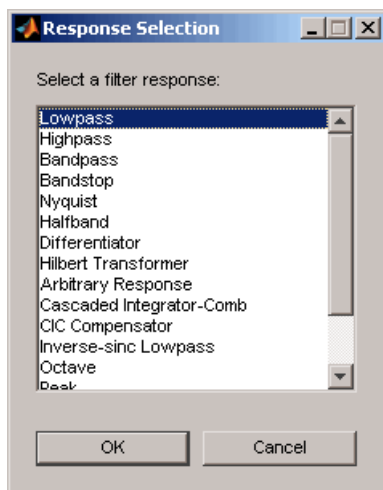

- 2 Hit the **OK** button. The **Lowpass Design** dialog box opens. Here you can specify the writable parameters of the Lowpass filter object. The components of the **Main** frame of this dialog box are described in the section titled *Lowpass Filter Design Dialog Box — Main Pane*. In the dialog box, make the following changes:
  - Enter a  $F_{pass}$  value of 0.55.
  - Enter a  $F_{stop}$  value of 0.65.



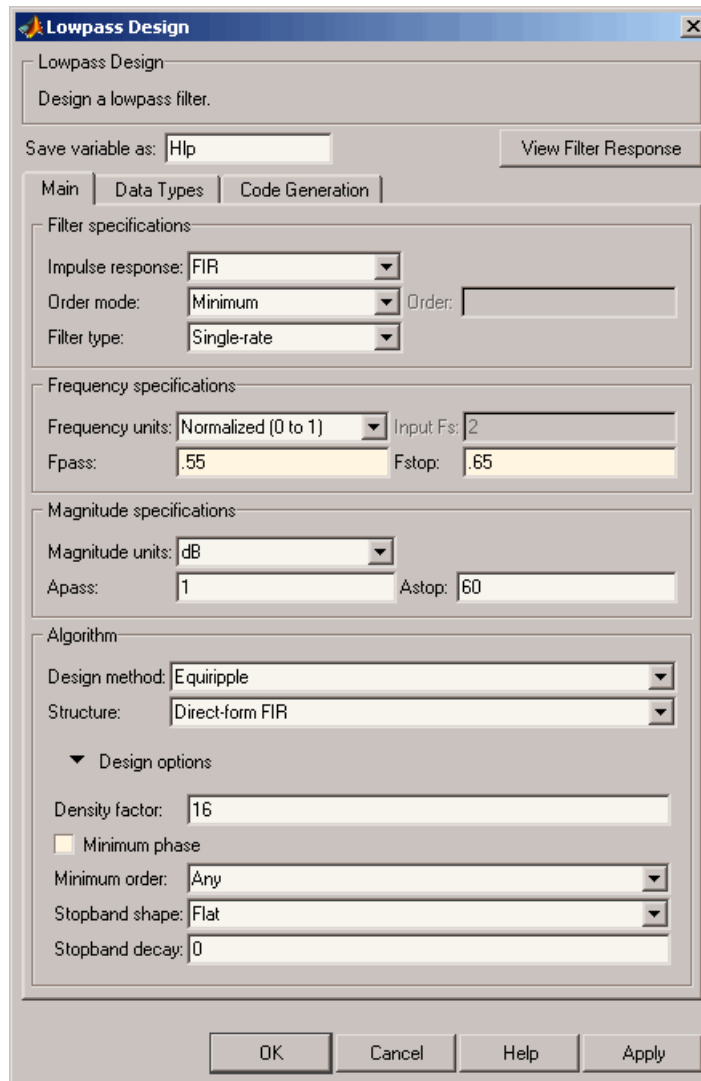

**3** Click **Apply**, and the following message appears at the MATLAB prompt:

The variable 'Hlp' has been exported to the command window.

- 4 To check your design, click **View Filter Response**. The Filter Visualization tool appears, showing a plot of the magnitude response of the filter.

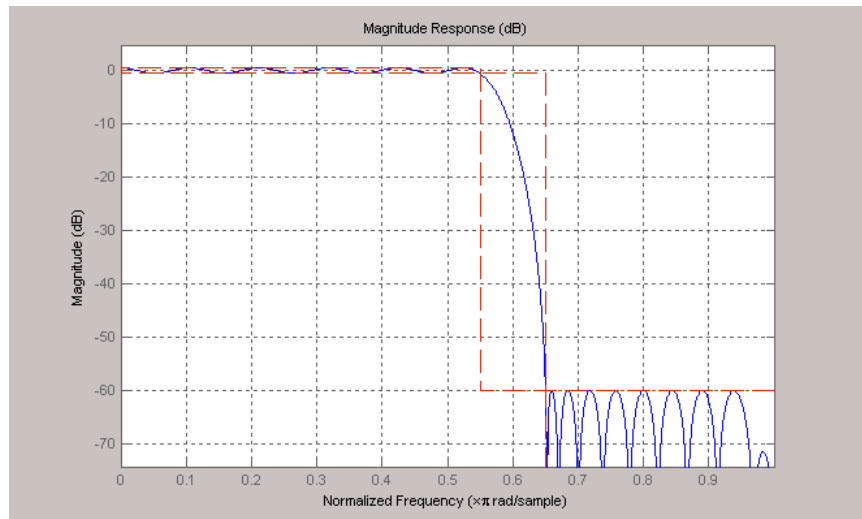

You can change the design and click **Apply**, followed by **View Filter Response**, as many times as needed until your design specifications are met.

# FDATool: A Filter Design and Analysis GUI

---

- “Overview” on page 5-2
- “Using FDATool” on page 5-6
- “Importing a Filter Design” on page 5-39

## Overview

In this section...
“FDATool” on page 5-2
“Filter Design Methods” on page 5-2
“Using the Filter Design and Analysis Tool” on page 5-4
“Analyzing Filter Responses” on page 5-4
“Filter Design and Analysis Tool Panels” on page 5-4
“Getting Help” on page 5-5

## FDATool

The Filter Design and Analysis Tool (FDATool) is a user interface for designing and analyzing filters quickly. FDATool enables you to design digital FIR or IIR filters by setting filter specifications, by importing filters from your MATLAB workspace, or by adding, moving or deleting poles and zeros. FDATool also provides tools for analyzing filters, such as magnitude and phase response and pole-zero plots.

## Filter Design Methods

FDATool gives you access to the following Signal Processing Toolbox filter design methods.

Design Method	Function
Butterworth	butter
Chebyshev Type I	cheby1
Chebyshev Type II	cheby2
Elliptic	ellip
Maximally Flat	maxflat
Equiripple	firpm
Least-squares	firls

<b>Design Method</b>	<b>Function</b>
Constrained least-squares	<code>fircls</code>
Complex equiripple	<code>cfirpm</code>
Window	<code>fir1</code>

When using the window method in FDATool, all Signal Processing Toolbox window functions are available, and you can specify a user-defined window by entering its function name and input parameter.

### Advanced Filter Design Methods

The following advanced filter design methods are available if you have DSP System Toolbox software.

<b>Design Method</b>	<b>Function</b>
Constrained equiripple FIR	<code>firceqrip</code>
Constrained-band equiripple FIR	<code>fircband</code>
Generalized remez FIR	<code>firgr</code>
Equiripple halfband FIR	<code>firhalfband</code>
Least P-norm optimal FIR	<code>firlpnorm</code>
Equiripple Nyquist FIR	<code>firnyquist</code>
Interpolated FIR	<code>ifir</code>
IIR comb notching or peaking	<code>iircomb</code>
Allpass filter (given group delay)	<code>iigrpdelay</code>
Least P-norm optimal IIR	<code>iirlpnorm</code>
Constrained least P-norm IIR	<code>iirlpnormc</code>
Second-order IIR notch	<code>iirnotch</code>
Second-order IIR peaking (resonator)	<code>iirpeak</code>

## Using the Filter Design and Analysis Tool

There are different ways that you can design filters using the Filter Design and Analysis Tool. For example:

- You can first choose a response type, such as bandpass, and then choose from the available FIR or IIR filter design methods.
- You can specify the filter by its type alone, along with certain frequency- or time-domain specifications such as passband frequencies and stopband frequencies. The filter you design is then computed using the default filter design method and filter order.

## Analyzing Filter Responses

Once you have designed your filter, you can display the filter coefficients and detailed filter information, export the coefficients to the MATLAB workspace, and create a C header file containing the coefficients, and analyze different filter responses in FDATool or in a separate Filter Visualization Tool (fvtool). The following filter responses are available:

- Magnitude response (`freqz`)
- Phase response (`phasez`)
- Group delay (`grpdelay`)
- Phase delay (`phasedelay`)
- Impulse response (`impz`)
- Step response (`stepz`)
- Pole-zero plots (`zplane`)
- Zero-phase response (`zerophase`)

## Filter Design and Analysis Tool Panels

The Filter Design and Analysis Tool has sidebar buttons that display particular panels in the lower half of the tool. The panels are

- Design Filter. See “Choosing a Filter Design Method” on page 5-8 for more information. You use this panel to
  - Design filters from scratch.

- Modify existing filters designed in FDATool.
- Analyze filters.
- Import filter. You use this panel to
  - Import previously saved filters or filter coefficients that you have stored in the MATLAB workspace.
  - Analyze imported filters.
- Pole/Zero Editor. See “Editing the Filter Using the Pole/Zero Editor” on page 5-19. You use this panel to add, delete, and move poles and zeros in your filter design.

If you also have DSP System Toolbox product installed, additional panels are available:

- Set quantization parameters — Use this panel to quantize double-precision filters that you design in FDATool, quantize double-precision filters that you import into FDATool, and analyze quantized filters.
- Transform filter — Use this panel to change a filter from one response type to another.
- Multirate filter design — Use this panel to create a multirate filter from your existing FIR design, create CIC filters, and linear and hold interpolators.

If you have Simulink installed, this panel is available:

- Realize Model — Use this panel to create a Simulink block containing the filter structure.

## Getting Help

At any time, you can right-click or click the **What's this?** button, , to get information on the different parts of the tool. You can also use the **Help** menu to see complete Help information.

## Using FDATool

To open FDATool, type

```
fdatool
```

at the MATLAB command prompt.

The Filter Design and Analysis Tool opens with the Design Filter panel displayed.

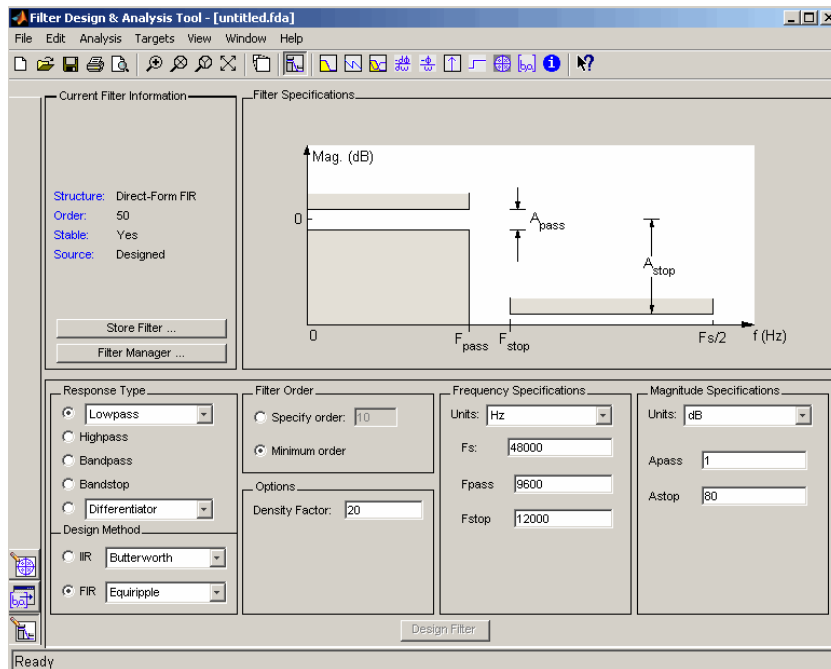

Note that when you open FDATool, **Design Filter** is not enabled. You must make a change to the default filter design in order to enable **Design Filter**. This is true each time you want to change the filter design. Changes to radio button items or drop down menu items such as those under **Response Type** or **Filter Order** enable **Design Filter** immediately. Changes to specifications in text boxes such as **F<sub>s</sub>**, **F<sub>pass</sub>**, and **F<sub>stop</sub>** require you to click outside the text box to enable **Design Filter**.



## Choosing a Response Type

You can choose from several response types:

- Lowpass
- Raised cosine
- Highpass
- Bandpass
- Bandstop
- Differentiator
- Multiband
- Hilbert transformer
- Arbitrary magnitude

Additional response types are available if you have DSP System Toolbox software installed.

To design a bandpass filter, select the radio button next to **Bandpass** in the Response Type region of the GUI.

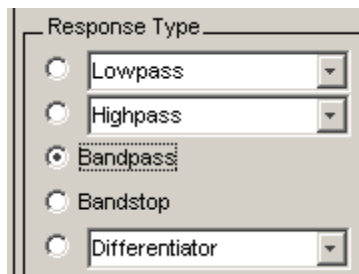

---

**Note** Not all filter design methods are available for all response types. Once you choose your response type, this may restrict the filter design methods available to you. Filter design methods that are not available for a selected response type are removed from the Design Method region of the GUI.

---

## Choosing a Filter Design Method

You can use the default filter design method for the response type that you've selected, or you can select a filter design method from the available FIR and IIR methods listed in the GUI.

To select the Remez algorithm to compute FIR filter coefficients, select the **FIR** radio button and choose Equiripple from the list of methods.

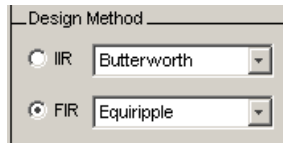

## Setting the Filter Design Specifications

- “Viewing Filter Specifications” on page 5-8
- “Filter Order” on page 5-9
- “Options” on page 5-9
- “Bandpass Filter Frequency Specifications” on page 5-10
- “Bandpass Filter Magnitude Specifications” on page 5-12

## Viewing Filter Specifications

The filter design specifications that you can set vary according to response type and design method. The display region illustrates filter specifications when you select **Analysis > Filter Specifications** or when you click the **Filter Specifications** toolbar button.

You can also view the filter specifications on the Magnitude plot of a designed filter by selecting **View > Specification Mask**.

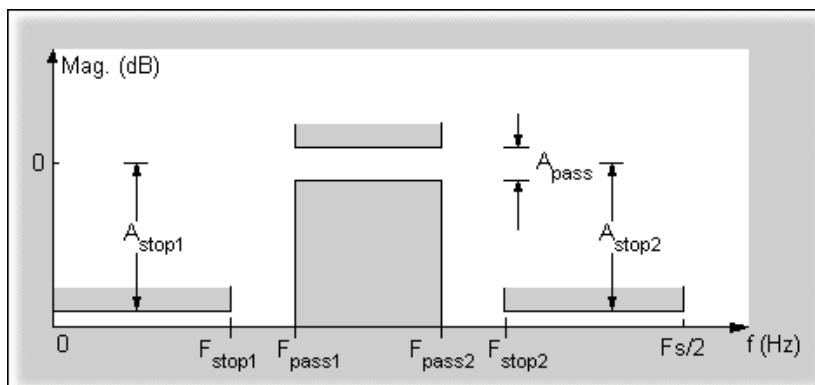

## Filter Order

You have two mutually exclusive options for determining the filter order when you design an equiripple filter:

- **Specify order:** You enter the filter order in a text box.
- **Minimum order:** The filter design method determines the minimum order filter.

Select the **Minimum order** radio button for this example.

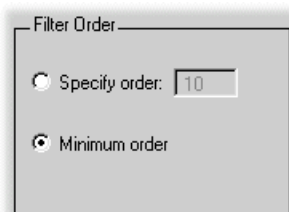

Note that filter order specification options depend on the filter design method you choose. Some filter methods may not have both options available.

## Options

The available options depend on the selected filter design method. Only the FIR Equiripple and FIR Window design methods have settable options.

For FIR Equiripple, the option is a **Density Factor**. See `firpm` for more information. For FIR Window the options are **Scale Passband**, **Window selection**, and for the following windows, a settable parameter:

Window	Parameter
Chebyshev ( <code>chebwin</code> )	Sidelobe attenuation
Gaussian ( <code>gausswin</code> )	Alpha
Kaiser ( <code>kaiser</code> )	Beta
Taylor ( <code>taylorwin</code> )	Nbar and Sidelobe level
Tukey ( <code>tukeywin</code> )	Alpha
User Defined	Function Name, Parameter

You can view the window in the Window Visualization Tool (`wvtool`) by clicking the **View** button.

For this example, set the **Density factor** to 16.

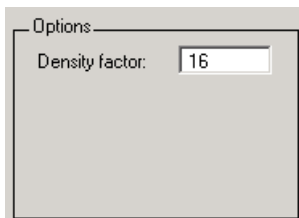

### Bandpass Filter Frequency Specifications

For a bandpass filter, you can set

- Units of frequency:
  - Hz
  - kHz
  - MHz
  - Normalized (0 to 1)

- Sampling frequency
- Passband frequencies
- Stopband frequencies

You specify the passband with two frequencies. The first frequency determines the lower edge of the passband, and the second frequency determines the upper edge of the passband.

Similarly, you specify the stopband with two frequencies. The first frequency determines the upper edge of the first stopband, and the second frequency determines the lower edge of the second stopband.

For this example:

- Keep the units in **Hz** (default).
- Set the sampling frequency (**F<sub>s</sub>**) to 2000 Hz.
- Set the end of the first stopband (**F<sub>stop1</sub>**) to 200 Hz.
- Set the beginning of the passband (**F<sub>pass1</sub>**) to 300 Hz.
- Set the end of the passband (**F<sub>pass2</sub>**) to 700 Hz.
- Set the beginning of the second stopband (**F<sub>stop2</sub>**) to 800 Hz.

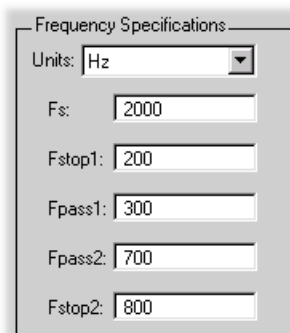

The image shows a dialog box titled "Frequency Specifications". It contains several input fields and a dropdown menu. The "Units" dropdown is set to "Hz". The "Fs" field is set to "2000". The "Fstop1" field is set to "200". The "Fpass1" field is set to "300". The "Fpass2" field is set to "700". The "Fstop2" field is set to "800".

Parameter	Value
Units	Hz
F <sub>s</sub>	2000
F <sub>stop1</sub>	200
F <sub>pass1</sub>	300
F <sub>pass2</sub>	700
F <sub>stop2</sub>	800

### Bandpass Filter Magnitude Specifications

For a bandpass filter, you can specify the following magnitude response characteristics:

- Units for the magnitude response (dB or linear)
- Passband ripple
- Stopband attenuation

For this example:

- Keep **Units** in dB (default).
- Set the passband ripple (**A<sub>pass</sub>**) to 0.1 dB.
- Set the stopband attenuation for both stopbands (**A<sub>stop1</sub>**, **A<sub>stop2</sub>**) to 75 dB.

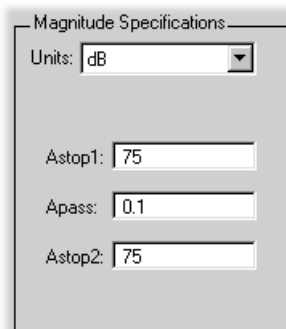

Magnitude Specifications

Units: dB

Astop1: 75

Apass: 0.1

Astop2: 75

### Computing the Filter Coefficients

Now that you've specified the filter design, click the **Design Filter** button to compute the filter coefficients.

Notice that the Design Filter button is disabled once you've computed the coefficients for your filter design. This button is enabled again once you make any changes to the filter specifications.

## Analyzing the Filter

- “Displaying Filter Responses” on page 5-13
- “Using Data Tips” on page 5-15
- “Drawing Spectral Masks” on page 5-16
- “Changing the Sampling Frequency” on page 5-17
- “Displaying the Response in FVTool” on page 5-18

## Displaying Filter Responses

You can view the following filter response characteristics in the display region or in a separate window.

- Magnitude response
- Phase response
- Magnitude and Phase responses
- Group delay response
- Phase delay response
- Impulse response
- Step response
- Pole-zero plot
- Zero-phase response — available from the *y*-axis context menu in a Magnitude or Magnitude and Phase response plot.

If you have DSP System Toolbox product installed, two other analyses are available: magnitude response estimate and round-off noise power. These two analyses are the only ones that use filter internals.

For descriptions of the above responses and their associated toolbar buttons and other FDATool toolbar buttons, see `fvtool`.

You can display two responses in the same plot by selecting **Analysis > Overlay Analysis** and selecting an available response. A second

y-axis is added to the right side of the response plot. (Note that not all responses can be overlaid on each other.)

You can also display the filter coefficients and detailed filter information in this region.

For all the analysis methods, except zero-phase response, you can access them from the **Analysis** menu, the Analysis Parameters dialog box from the context menu, or by using the toolbar buttons. For zero-phase, right-click the y-axis of the plot and select **Zero-phase** from the context menu.



For example, to look at the filter's magnitude response, select the **Magnitude Response** button  on the toolbar.

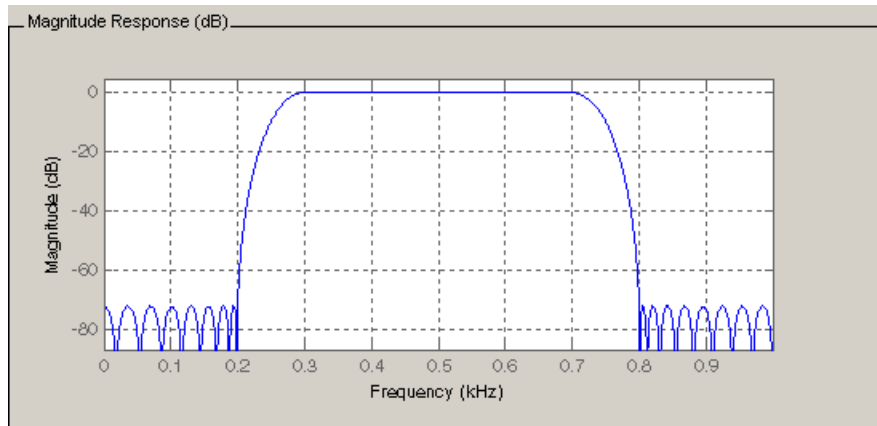

You can also overlay the filter specifications on the Magnitude plot by selecting **View > Specification Mask**.

---

**Note** You can use specification masks in FVTool only if FVTool was launched from FDATool.

---



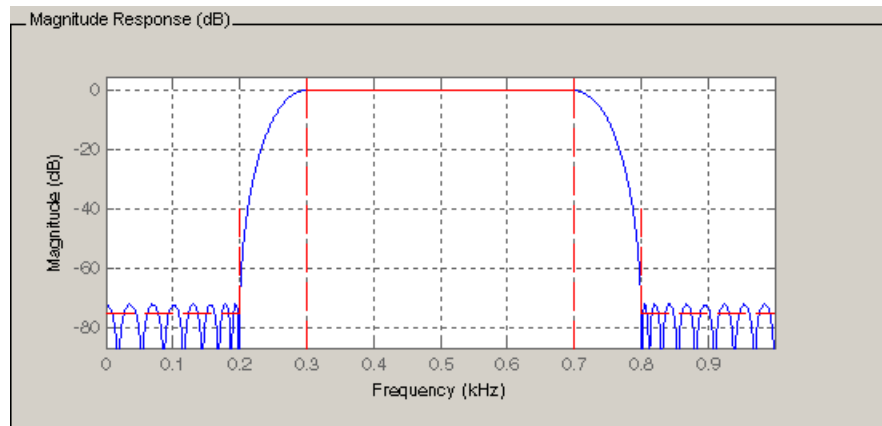

### Using Data Tips

You can click the response to add plot data tips that display information about particular points on the response.

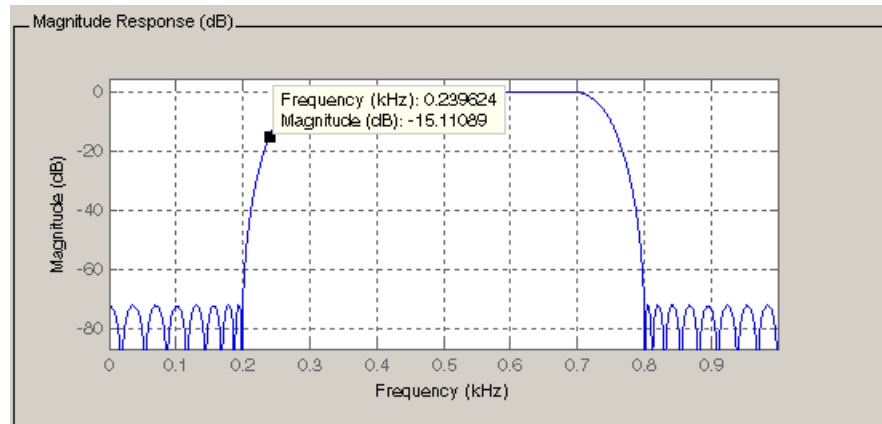

For information on using data tips, see “Data Cursor — Displaying Data Values Interactively” in the MATLAB documentation.

## Drawing Spectral Masks

To add spectral masks or rejection area lines to your magnitude plot, click **View > User-defined Spectral Mask**.

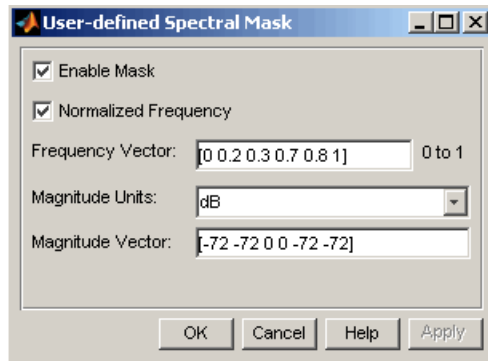

The mask is defined by a frequency vector and a magnitude vector. These vectors must be the same length.

- **Enable Mask** — Select to turn on the mask display.
- **Normalized Frequency** — Select to normalize the frequency between 0 and 1 across the displayed frequency range.
- **Frequency Vector** — Enter a vector of  $x$ -axis frequency values.
- **Magnitude Units** — Select the desired magnitude units. These units should match the units used in the magnitude plot.
- **Magnitude Vector** — Enter a vector of  $y$ -axis magnitude values.

The magnitude response below shows a spectral mask.

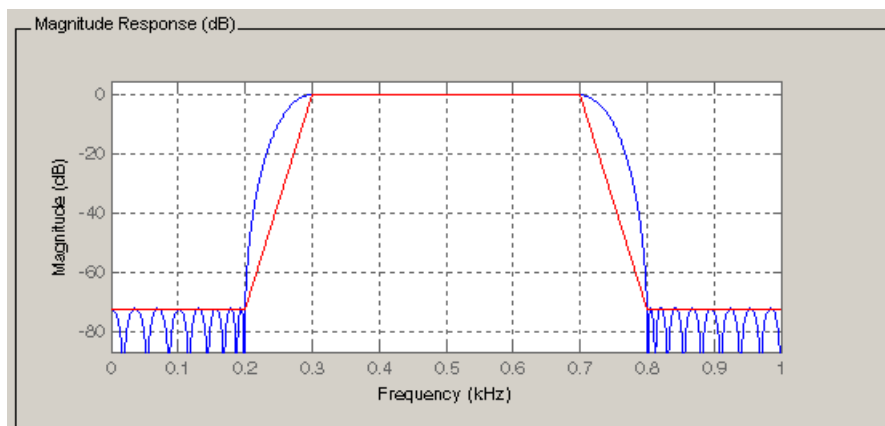

## Changing the Sampling Frequency

To change the sampling frequency of your filter, right-click any filter response plot and select **Sampling Frequency** from the context menu.

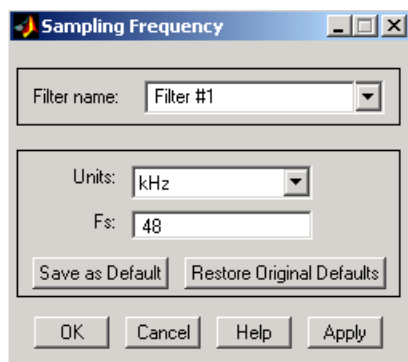

To change the filter name, type the new name in **Filter name**. (In `fvtool`, if you have multiple filters, select the desired filter and then enter the new name.)

To change the sampling frequency, select the desired unit from **Units** and enter the sampling frequency in **Fs**. (For each filter in `fvtool`, you can specify a different sampling frequency or you can apply the sampling frequency to all filters.)

To save the displayed parameters as the default values to use when FDATool or FVTool is opened, click **Save as Default**.

To restore the default values, click **Restore Original Defaults**.

### Displaying the Response in FVTool

To display the filter response characteristics in a separate window, select **View > Filter Visualization Tool** (available if any analysis, except the filter specifications, is in the display region) or click the **Full View Analysis**

button: 

This launches the Filter Visualization Tool (fvtool).

---

**Note** If Filter Specifications are shown in the display region, clicking the **Full View Analysis** toolbar button launches a MATLAB figure window instead of FVTool. The associated menu item is **Print to figure**, which is enabled only if the filter specifications are displayed.

---

You can use this tool to annotate your design, view other filter characteristics, and print your filter response. You can link FDATool and FVTool so that changes made in FDATool are immediately reflected in FVTool. See fvtool for more information.

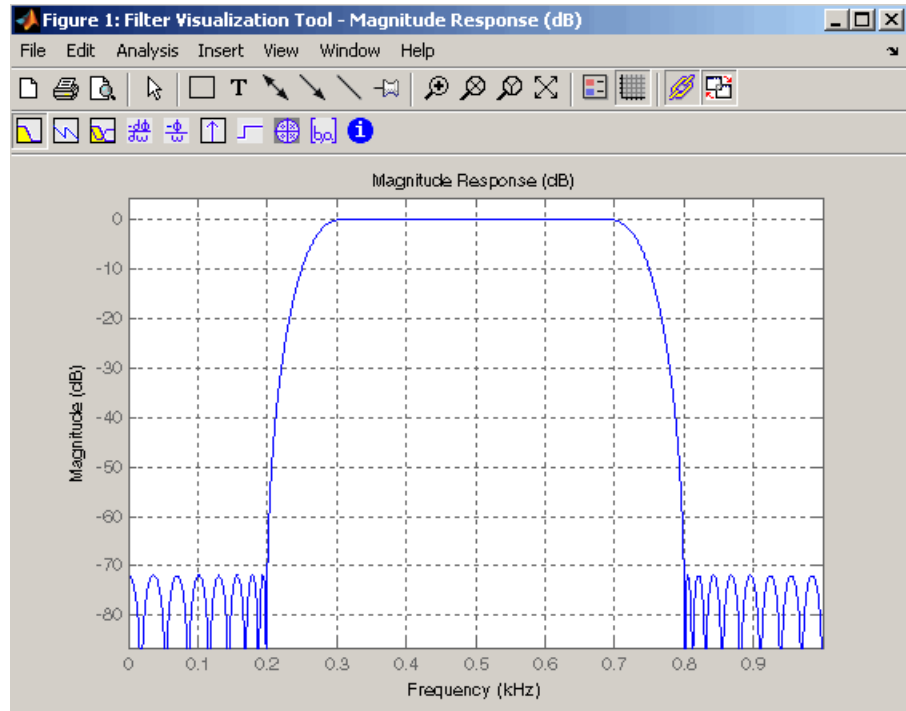

## Editing the Filter Using the Pole/Zero Editor

- “Displaying the Pole-Zero Plot” on page 5-19
- “Changing the Pole-Zero Plot” on page 5-20

### Displaying the Pole-Zero Plot

You can edit a designed or imported filter’s coefficients by moving, deleting, or adding poles and/or zeros using the Pole/Zero Editor panel.

**Note** You cannot generate MATLAB code (**File > Generate MATLAB code**) if your filter was designed or edited with the Pole/Zero Editor.

You cannot move quantized poles and zeros. You can only move the reference poles and zeros.

Click the **Pole/Zero Editor** button in the sidebar or select **Edit > Pole/Zero Editor** to display this panel.

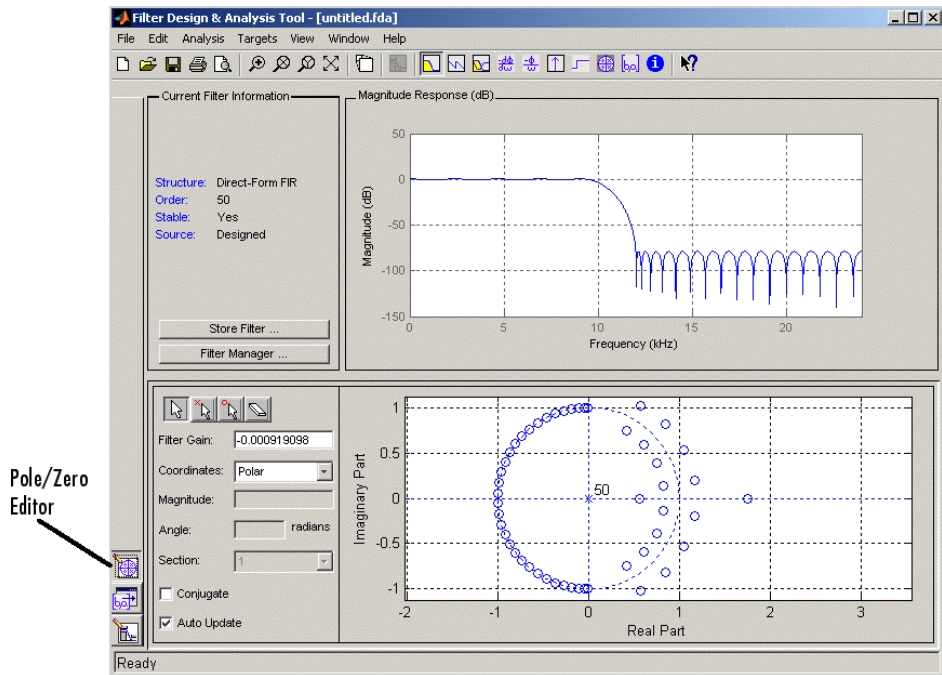

Poles are shown using x symbols and zeros are shown using o symbols.

### Changing the Pole-Zero Plot

Plot mode buttons are located to the left of the pole/zero plot. Select one of the buttons to change the mode of the pole/zero plot. The Pole/Zero Editor has

these buttons from left to right: move pole, add pole, add zero, and delete pole or zero.

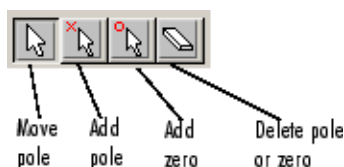

The following plot parameters and controls are located to the left of the pole/zero plot and below the plot mode buttons.

- **Filter gain** — factor to compensate for the filter's pole(s) and zero(s) gains
- **Coordinates** — units (Polar or Rectangular) of the selected pole or zero
- **Magnitude** — if polar coordinates is selected, magnitude of the selected pole or zero
- **Angle** — if polar coordinates is selected, angle of selected pole(s) or zero(s)
- **Real** — if rectangular coordinates is selected, real component of selected pole(s) or zero(s)
- **Imaginary** — if rectangular coordinates is selected, imaginary component of selected pole or zero
- **Section** — for multisection filters, number of the current section
- **Conjugate** — creates a corresponding conjugate pole or zero or automatically selects the conjugate pole or zero if it already exists.
- **Auto update** — immediately updates the displayed magnitude response when poles or zeros are added, moved, or deleted.

The **Edit > Pole/Zero Editor** has items for selecting multiple poles/zeros, for inverting and mirroring poles/zeros, and for deleting, scaling and rotating poles/zeros.

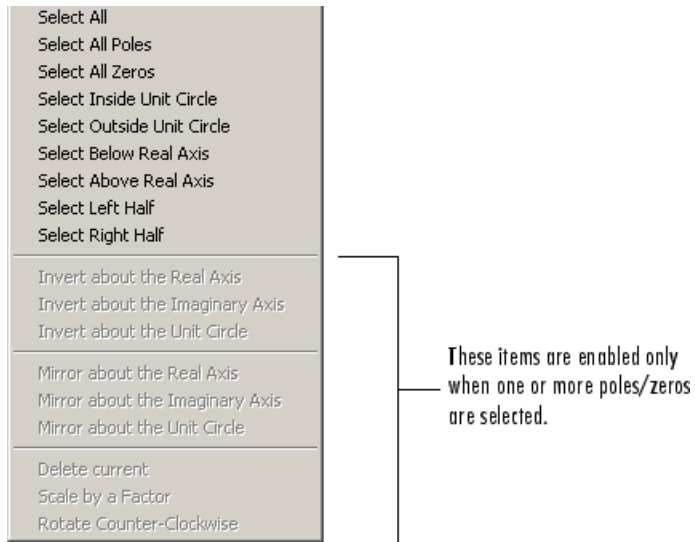

Moving one of the zeros on the vertical axis produces the following result:



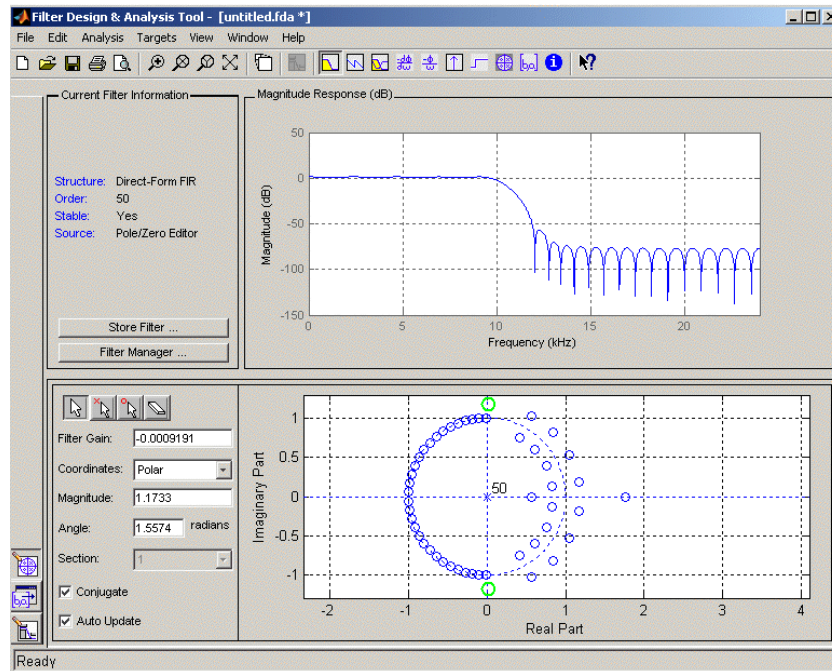

- The selected zero pair is shown in green.
- When you select one of the zeros from a conjugate pair, the Conjugate check box and the conjugate are automatically selected.
- The Magnitude Response plot updates immediately because **Auto update** is active.

## Converting the Filter Structure

- “Converting to a New Structure” on page 5-23
- “Converting to Second-Order Sections” on page 5-25

## Converting to a New Structure

You can use **Edit > Convert Structure** to convert the current filter to a new structure. All filters can be converted to the following representations:

- Direct-form I
- Direct-form II
- Direct-form I transposed
- Direct-form II transposed
- Lattice ARMA

---

**Note** If you have DSP System Toolbox product installed, you will see additional structures in the Convert structure dialog box.

---

In addition, the following conversions are available for particular classes of filters:

- Minimum phase FIR filters can be converted to Lattice minimum phase
- Maximum phase FIR filters can be converted to Lattice maximum phase
- Allpass filters can be converted to Lattice allpass
- IIR filters can be converted to Lattice ARMA

---

**Note** Converting from one filter structure to another may produce a result with different characteristics than the original. This is due to the computer's finite-precision arithmetic and the variations in the conversion's roundoff computations.

---

For example:

- Select **Edit > Convert Structure** to open the Convert structure dialog box.
- Select `Direct-form I` in the list of filter structures.

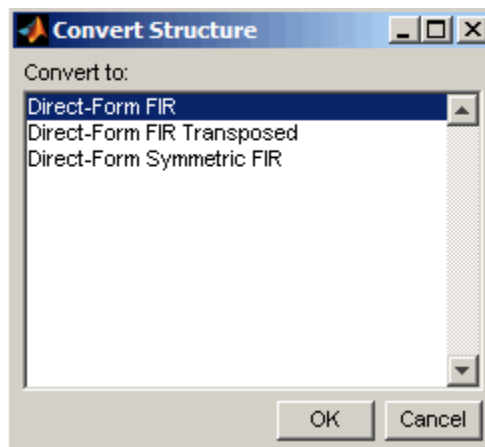

### Converting to Second-Order Sections

You can use **Edit > Convert to Second-Order Sections** to store the converted filter structure as a collection of second-order sections rather than as a monolithic higher-order structure.

---

**Note** The following options are also used for **Edit > Reorder and Scale Second-Order Sections**, which you use to modify an SOS filter structure.

---

The following **Scale** options are available when converting a direct-form II structure only:

- None (default)
- L-2 ( $L^2$  norm)
- L-infinity ( $L^\infty$  norm)

The **Direction** (Up or Down) determines the ordering of the second-order sections. The optimal ordering changes depending on the **Scale** option selected.

For example:

- Select **Edit > Convert to Second-Order Sections** to open the Convert to SOS dialog box.
- Select L-infinity from the **Scale** menu for  $L^\infty$  norm scaling.
- Leave Up as the **Direction** option.

---

**Note** To convert from second-order sections back to a single section, use **Edit > Convert to Single Section**.

---

### Exporting a Filter Design

- “Exporting Coefficients or Objects to the Workspace” on page 5-26
- “Exporting Coefficients to an ASCII File” on page 5-27
- “Exporting Coefficients or Objects to a MAT-File” on page 5-28
- “Exporting to SPTool” on page 5-29
- “Exporting to a Simulink Model” on page 5-29
- “Other Ways to Export a Filter” on page 5-32

### Exporting Coefficients or Objects to the Workspace

You can save the filter either as filter coefficients variables or as a `dfilt` or `mfilt` filter object variable. (Note that you must have DSP System Toolbox product installed to save as an `mfilt`.) To save the filter to the MATLAB workspace:

- 1** Select **File > Export**. The Export dialog box appears.
- 2** Select Workspace from the **Export To** menu.
- 3** Select **Coefficients** from the **Export As** menu to save the filter coefficients or select **Objects** to save the filter in a filter object.
- 4** For coefficients, assign variable names using the **Numerator** (for FIR filters) or **Numerator** and **Denominator** (for IIR filters), or **SOS Matrix** and **Scale Values** (for IIR filters in second-order section form) text boxes in the Variable Names region.

For objects, assign the variable name in the **Discrete Filter** (or **Quantized Filter**) text box. If you have variables with the same names in your workspace and you want to overwrite them, select the **Overwrite Variables** check box.

- 5 Click the **Export** button.

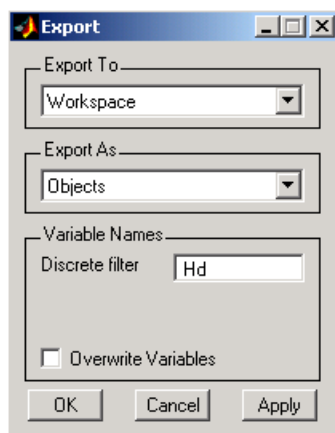
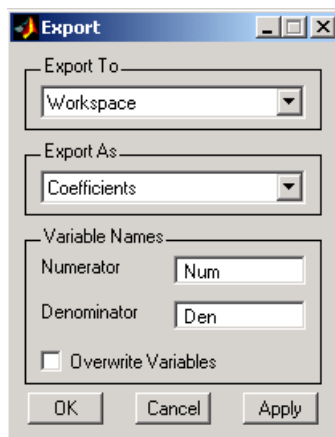

## Exporting Coefficients to an ASCII File

To save filter coefficients to a text file,

- 1 Select **File > Export**. The Export dialog box appears.
- 2 Select **Coefficients File (ASCII)** from the **Export To** menu.
- 3 Click the **Export** button. The Export Filter Coefficients to .FCF File dialog box appears.
- 4 Choose or enter a filename and click the **Save** button.

The coefficients are saved in the text file that you specified, and the MATLAB Editor opens to display the file. The text file also contains comments with the MATLAB version number, the Signal Processing Toolbox version number, and filter information.

### **Exporting Coefficients or Objects to a MAT-File**

To save filter coefficients or a filter object as variables in a MAT-file:

- 1 Select **File > Export**. The Export dialog box appears.
- 2 Select **MAT-file** from the **Export To** menu.
- 3 Select **Coefficients** from the **Export As** menu to save the filter coefficients or select **Objects** to save the filter in a filter object.
- 4 For coefficients, assign variable names using the **Numerator** (for FIR filters) or **Numerator** and **Denominator** (for IIR filters), or **SOS Matrix** and **Scale Values** (for IIR filters in second-order section form) text boxes in the Variable Names region.

For objects, assign the variable name in the **Discrete Filter (or Quantized Filter)** text box. If you have variables with the same names in your workspace and you want to overwrite them, select the **Overwrite Variables** check box.

- 5 Click the **Export** button. The Export to a MAT-File dialog box appears.
- 6 Choose or enter a filename and click the **Save** button.

## Exporting to SPTool

You may want to use your designed filter in SPTool to do signal processing and analysis.

- 1 Select **File > Export**. The Export dialog box appears.
- 2 Select SPTool from the **Export To** menu.
- 3 Assign the variable name in the **Discrete Filter (or Quantized Filter)** text box. If you have variables with the same names in your workspace and you want to overwrite them, select the **Overwrite Variables** check box.
- 4 Click the **Export** button.

SPTool opens and the current FDATool filter appears in the Filter area list as the specified variable name followed by (Imported).

---

**Note** If you are using the DSP System Toolbox software and export a quantized filter, only the values of its quantized coefficients are exported. The reference coefficients are not exported. SPTool does not restrict the coefficient values, so if you edit them in SPTool by moving poles or zeros, the filter will no longer be in quantized form.

---

## Exporting to a Simulink Model

If you have the Simulink product installed, you can export a Simulink block of your filter design and insert it into a new or existing Simulink model.

You can export a filter designed using any filter design method available in FDATool.

---

**Note** If you have the DSP System Toolbox and Fixed-Point Toolbox™ installed, you can export a CIC filter to a Simulink model.

---

- 1 After designing your filter, click the **Realize Model** sidebar button or select **File > Export to Simulink Model**. The Realize Model panel is displayed.

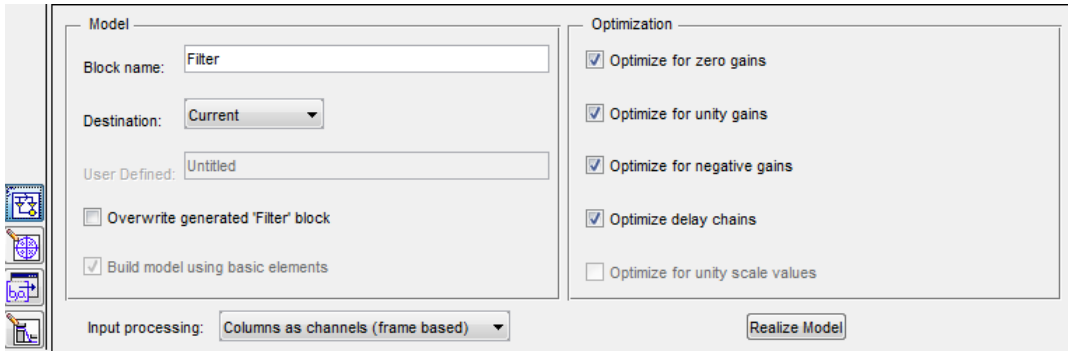

- 2 Specify the name to use for your block in **Block name**.
- 3 To insert the block into the current (most recently selected) Simulink model, set the **Destination** to Current. To inset the block into a new model, select New. To insert the block into a user-defined subsystem, select User defined.
- 4 If you want to overwrite a block previously created from this panel, check **Overwrite generated 'Filter' block**.
- 5 If you select the **Build model using basic elements** check box, your filter is created as a subsystem block, which uses separate sub-elements. In this mode, the following optimization(s) are available:
  - Optimize for zero gains — Removes zero-valued gain paths from the filter structure.
  - Optimize for unity gains — Substitutes a wire (short circuit) for gains equal to 1 in the filter structure.
  - Optimize for negative gains — Substitutes a wire (short circuit) for gains equal to -1 and changes corresponding additions to subtractions in the filter structure.
  - Optimize delay chains — Substitutes delay chains composed of n unit delays with a single delay of n.
  - Optimize for unity scale values — Removes multiplications for scale values equal to 1 from the filter structure.

The following illustration shows the effects of some of the optimizations:



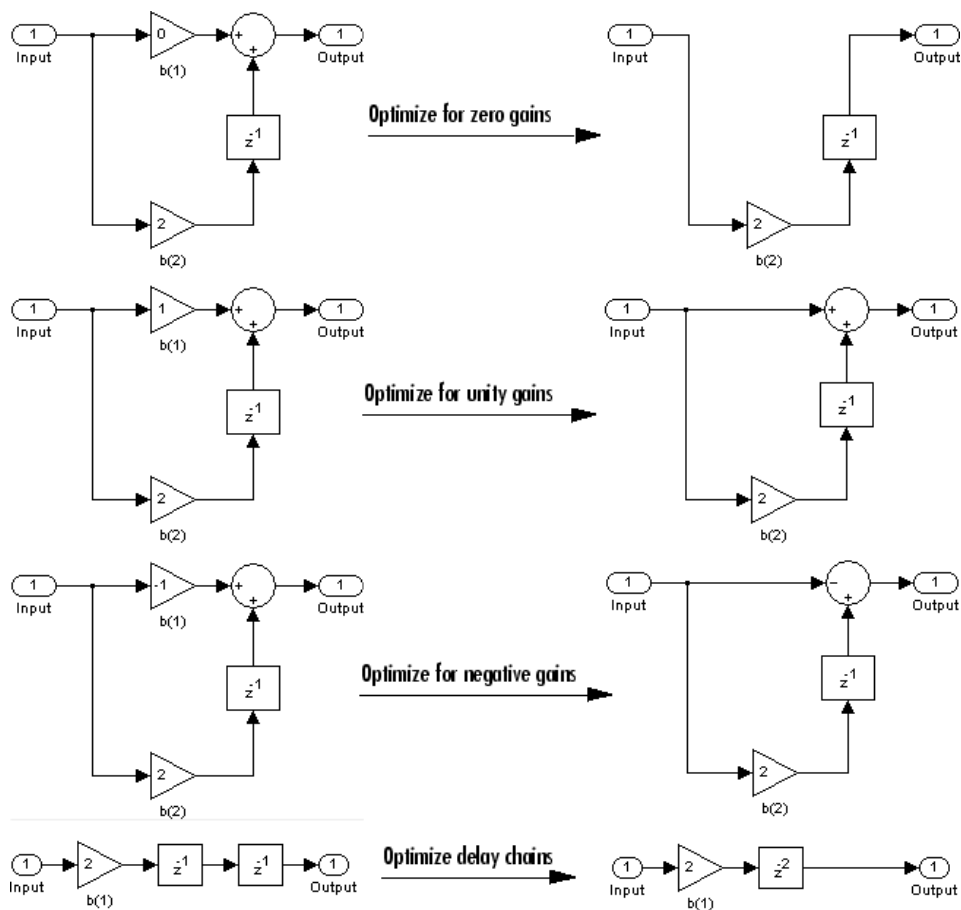

### Optimization Effects

**Note** The **Build model using basic elements** check box is enabled only when you have a DSP System Toolbox license and your filter can be designed using a Digital Filter block. For more information, see the Filter Realization Wizard topic in the DSP System Toolbox documentation.

- 6 Set the **Input processing** parameter to specify whether the generated filter performs sample- or frame-based processing on the input. Depending

on the type of filter you design, one or both of the following options may be available:

- **Columns as channels (frame based)** — When you select this option, the block treats each column of the input as a separate channel.
- **Elements as channels (sample based)** — When you select this option, the block treats each element of the input as a separate channel.

**7** Click the **Realize Model** button to create the filter block. When the **Build model using basic elements** check box is selected, FDATool implements the filter as a subsystem block using Sum, Gain, and Delay blocks.

If you double-click the Simulink Filter block, the filter structure is displayed.

### Other Ways to Export a Filter

You can also send your filter to a C header file or generate MATLAB code to construct your filter from the command line. For detailed instructions, see the following sections:

- “Generating a C Header File” on page 5-32
- “Generating MATLAB Code” on page 5-34

### Generating a C Header File

You may want to include filter information in an external C program. To create a C header file with variables that contain filter parameter data, follow this procedure:

- 1** Select **Targets > Generate C Header**. The Generate C Header dialog box appears.

- 2 Enter the variable names to be used in the C header file. The particular filter structure determines the variables that are created in the file

Filter Structure	Variable Parameter
Direct-form I Direct-form II Direct-form I transposed Direct-form II transposed	Numerator, Numerator length*, Denominator, Denominator length*, and Number of sections (inactive if filter has only one section)
Lattice ARMA	Lattice coeffs, Lattice coeffs length*, Ladder coeffs, Ladder coeffs length*, Number of sections (inactive if filter has only one section)
Lattice MA	Lattice coeffs, Lattice coeffs length*, and Number of sections (inactive if filter has only one section)
Direct-form FIR Direct-form FIR transposed	Numerator, Numerator length*, and Number of sections (inactive if filter has only one section)

\***length** variables contain the total number of coefficients of that type.

---

**Note** Variable names cannot be C language reserved words, such as “for.”

---

- 3** Select **Export Suggested** to use the suggested data type or select **Export As** and select the desired data type from the pull-down.

---

**Note** If you do not have DSP System Toolbox software installed, selecting any data type other than double-precision floating point results in a filter that does not exactly match the one you designed in the FDATool. This is due to rounding and truncating differences.

---

- 4** Click **OK** to save the file and close the dialog box or click **Apply** to save the file, but leave the dialog box open for additional C header file definitions.

### Generating MATLAB Code

You can generate MATLAB code that constructs the filter you designed in FDATool from the command line. Select **File > Generate MATLAB Code > Filter Design Function** and specify the filename in the Generate MATLAB code dialog box.

---

**Note** You cannot generate MATLAB code (**File > Generate MATLAB Code > Filter Design Function**) if your filter was designed or edited with the Pole/Zero Editor.

---

The following is generated MATLAB code for the default lowpass filter in FDATool.

```
function Hd = ExFilter
%EXFILTER Returns a discrete-time filter object.

%
% MATLAB Code
% Generated by MATLAB(R) 7.11 and the Signal Processing Toolbox 6.14.
%
% Generated on: 17-Feb-2010 14:15:37
```

```
%  
  
% Equiripple Lowpass filter designed using the FIRPM function.  
  
% All frequency values are in Hz.  
Fs = 48000; % Sampling Frequency  
  
Fpass = 9600; % Passband Frequency  
Fstop = 12000; % Stopband Frequency  
Dpass = 0.057501127785; % Passband Ripple  
Dstop = 0.0001; % Stopband Attenuation  
dens = 20; % Density Factor  
  
% Calculate the order from the parameters using FIRPMORD.  
[N, Fo, Ao, W] = firpmord([Fpass, Fstop]/(Fs/2), [1 0], [Dpass, Dstop]);  
  
% Calculate the coefficients using the FIRPM function.  
b = firpm(N, Fo, Ao, W, {dens});  
Hd = dfilt.dffir(b);  
  
% [EOF]
```

## Managing Filters in the Current Session

You can store filters designed in the current FDATool session for cascading together, exporting to FVTool or for recalling later in the same or future FDATool sessions.

You store and access saved filters with the **Store filter** and **Filter Manager** buttons, respectively, in the Current Filter Information pane.

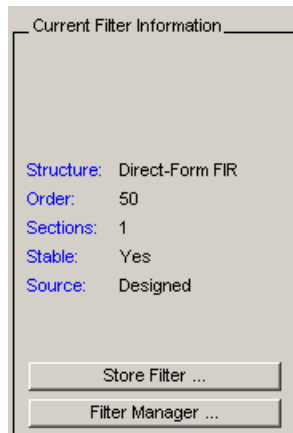

**Store Filter** — Displays the Store Filter dialog box in which you specify the filter name to use when storing the filter in the Filter Manager. The default name is the type of the filter.

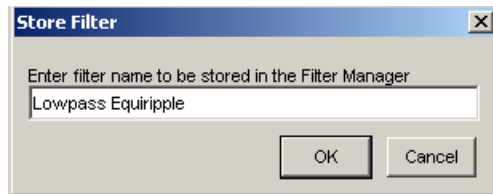

**Filter Manager** — Opens the Filter Manager.

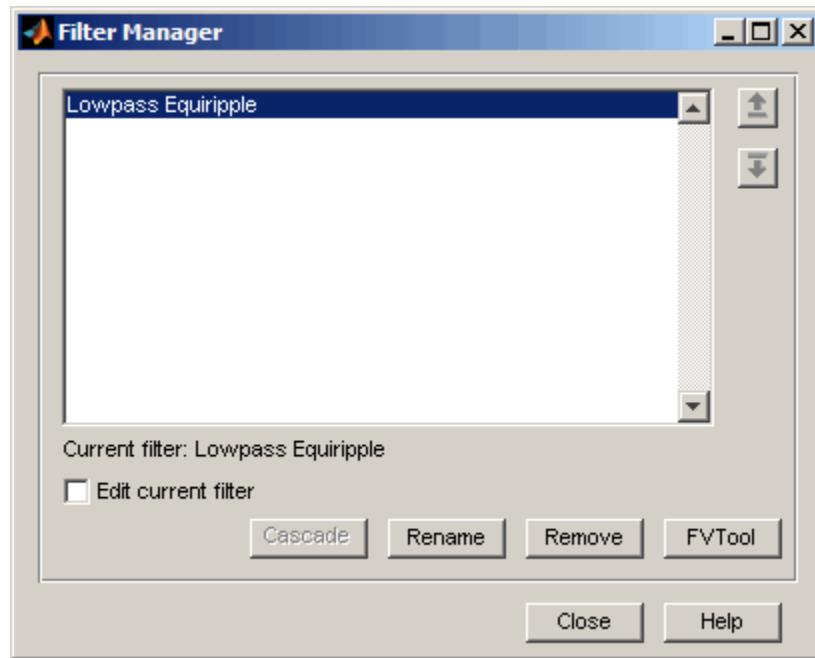

The current filter is listed below the listbox. To change the current filter, highlight the desired filter. If you select **Edit current filter**, FDATool displays the currently selected filter specifications. If you make any changes to the specifications, the stored filter is updated immediately.

To cascade two or more filters, highlight the desired filters and press **Cascade**. A new cascaded filter is added to the Filter Manager.

To change the name of a stored filter, press **Rename**. The Rename filter dialog box is displayed.

To remove a stored filter from the Filter Manager, press **Delete**.

To export one or more filters to FVTool, highlight the filter(s) and press **FVTool**.

## Saving and Opening Filter Design Sessions

You can save your filter design session as a MAT-file and return to the same session another time.

Select the **Save session** button  to save your session as a MAT-file. The first time you save a session, a Save Filter Design File browser opens, prompting you for a session name.

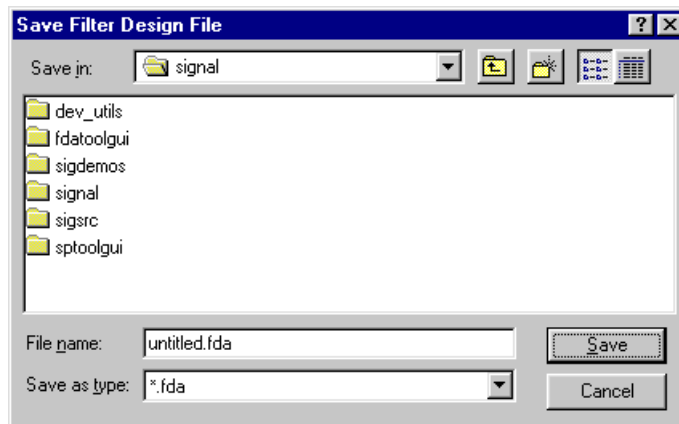

For example, save this design session as `TestFilter.fda` in your current working directory by typing `TestFilter` in the **File name** field.

The `.fda` extension is added automatically to all filter design sessions you save.

---

**Note** You can also use the **File > Save session** and **File > Save session as** to save a session.

---

You can load existing sessions into the Filter Design and Analysis Tool by selecting the **Open session** button,  or **File > Open session** . A Load Filter Design File browser opens that allows you to select from your previously saved filter design sessions.



## Importing a Filter Design

### In this section...

“Import Filter Panel” on page 5-39

“Filter Structures” on page 5-40

### Import Filter Panel

The Import Filter panel allows you to import a filter. You can access this region by clicking the **Import Filter** button in the sidebar.

The imported filter can be in any of the representations listed in the **Filter Structure** pull-down menu. You can import a filter as second-order sections by selecting the check box.

Specify the filter coefficients in **Numerator** and **Denominator**, either by entering them explicitly or by referring to variables in the MATLAB workspace.

Select the frequency units from the following options in the **Units** menu, and for any frequency unit other than Normalized, specify the value or MATLAB workspace variable of the sampling frequency in the **F<sub>s</sub>** field.

To import the filter, click the **Import Filter** button. The display region is automatically updated when the new filter has been imported.

You can edit the imported filter using the Pole/Zero Editor panel.

## Filter Structures

The available filter structures are:

- Direct Form, which includes direct-form I, direct-form II, direct-form I transposed, direct-form II transposed, and direct-form FIR
- Lattice, which includes lattice allpass, lattice MA min phase, lattice MA max phase, and lattice ARMA
- Discrete-time Filter (`dfilt` object)

The structure that you choose determines the type of coefficients that you need to specify in the text fields to the right.

### Direct-form

For direct-form I, direct-form II, direct-form I transposed, and direct-form II transposed, specify the filter by its transfer function representation

$$H(z) = \frac{b(1) + b(2)z^{-1} + b(3)z^{-2} + \dots + b(m+1)z^{-m}}{a(1) + a(2)z^{-1} + a(3)z^{-2} + \dots + a(n+1)z^{-n}}$$

- The **Numerator** field specifies a variable name or value for the numerator coefficient vector **b**, which contains  $m+1$  coefficients in descending powers of  $z$ .
- The **Denominator** field specifies a variable name or value for the denominator coefficient vector **a**, which contains  $n+1$  coefficients in descending powers of  $z$ . For FIR filters, the **Denominator** is 1.

Filters in transfer function form can be produced by all of the Signal Processing Toolbox filter design functions (such as `fir1`, `fir2`, `firpm`, `butter`, `yulewalk`). See “Transfer Function” on page 1-23 for more information.

**Importing as second-order sections.** For all direct-form structures, except direct-form FIR, you can import the filter in its second-order section representation:

$$H(z) = G \prod_{k=1}^L \frac{b_{0k} + b_{1k}z^{-1} + b_{2k}z^{-2}}{a_{0k} + a_{1k}z^{-1} + a_{2k}z^{-2}}$$

The **Gain** field specifies a variable name or a value for the gain  $G$ , and the **SOS Matrix** field specifies a variable name or a value for the  $L$ -by-6 SOS matrix

$$SOS = \begin{pmatrix} b_{01} & b_{11} & b_{21} & 1 & a_{11} & a_{21} \\ b_{02} & b_{12} & b_{22} & 1 & a_{12} & a_{22} \\ \cdot & \cdot & \cdot & \cdot & \cdot & \cdot \\ \cdot & \cdot & \cdot & \cdot & \cdot & \cdot \\ b_{0L} & b_{1L} & b_{2L} & 1 & a_{1L} & a_{2L} \end{pmatrix}$$

whose rows contain the numerator and denominator coefficients  $b_{ik}$  and  $a_{ik}$  of the second-order sections of  $H(z)$ .

Filters in second-order section form can be produced by functions such as `tf2sos`, `zp2sos`, `ss2sos`, and `sosfilt`. See “Second-Order Sections (SOS)” on page 1-27 for more information.

## Lattice

For lattice allpass, lattice minimum and maximum phase, and lattice ARMA filters, specify the filter by its lattice representation:

- For lattice allpass, the **Lattice coeff** field specifies the lattice (reflection) coefficients,  $k(1)$  to  $k(N)$ , where  $N$  is the filter order.
- For lattice MA (minimum or maximum phase), the **Lattice coeff** field specifies the lattice (reflection) coefficients,  $k(1)$  to  $k(N)$ , where  $N$  is the filter order.
- For lattice ARMA, the **Lattice coeff** field specifies the lattice (reflection) coefficients,  $k(1)$  to  $k(N)$ , and the **Ladder coeff** field specifies the ladder coefficients,  $v(1)$  to  $v(N+1)$ , where  $N$  is the filter order.

Filters in lattice form can be produced by `tf2latc`. See “Lattice Structure” on page 1-28 for more information.

**Discrete-time Filter (dfilt object)**

For Discrete-time filter, specify the name of the `dfilt` object. See `dfilt` for more information.

**Multirate Filter (mfilt object)**

For Multirate filter, specify the name of the `mfilt` object. See `mfilt` in the DSP System Toolbox product for more information.

# Statistical Signal Processing

---

The following chapter discusses statistical signal processing tools and applications, including correlations, covariance, and spectral estimation.

- “Correlation and Covariance” on page 6-2
- “Spectral Analysis” on page 6-5
- “Selected Bibliography” on page 6-46

## Correlation and Covariance

### In this section...

“Background Information” on page 6-2

“Using xcorr and xcov Functions” on page 6-3

“Bias and Normalization” on page 6-3

“Multiple Channels” on page 6-4

### Background Information

The cross-correlation sequence for two wide-sense stationary random process,  $x(n)$  and  $y(n)$  is:

$$R_{xy}(m) = E\{x(n+m)y^*(n)\}$$

where  $*$  denotes the complex conjugate and the expectation is over the ensemble of realizations that constitute the random processes.

Note that cross-correlation is not commutative, but a Hermitian (conjugate) symmetry property holds such that:

$$R_{xy}(m) = R_{yx}^*(-m)$$

The cross-covariance between  $x(n)$  and  $y(n)$  is:

$$C_{xy}(m) = E\{(x(n+m) - \mu_x)(y(n) - \mu_y)^*\} = R_{xy}(m) - \mu_x\mu_y^*$$

For zero-mean wide-sense stationary random processes, the cross-correlation and cross-covariance are equivalent.

In practice, you must estimate these sequences, because it is possible to access only a finite segment of the infinite-length random processes. Further, it is often necessary to estimate ensemble moments based on time averages because only a single realization of the random processes are available. A common estimate based on  $N$  samples of  $x_n$  and  $y_n$  is the deterministic cross-correlation sequence (also called the time-ambiguity function)

$$\hat{R}_{xy}(m) = \begin{cases} \sum_{n=0}^{N-m-1} x(n+m)y^*(n) & m \geq 0 \\ \hat{R}_{xy}^*(-m) & m < 0 \end{cases}$$

where we assume for this discussion that  $x_n$  and  $y_n$  are indexed from 0 to  $N-1$ , and  $\hat{R}_{xy}(m)$  from  $-(N-1)$  to  $N-1$ .

## Using `xcorr` and `xcov` Functions

The functions `xcorr` and `xcov` estimate the cross-correlation and cross-covariance sequences of random processes. They also handle autocorrelation and autocovariance as special cases. The `xcorr` function evaluates the sum shown above with an efficient FFT-based algorithm, given inputs  $x_n$  and  $y_n$  stored in length  $N$  vectors `x` and `y`. Its operation is equivalent to convolution with one of the two subsequences reversed in time.

For example:

```
x = [1 1 1 1 1]';
y = x;
xyc = xcorr(x,y)
```

Notice that the resulting sequence length is one less than twice the length of the input sequence. Thus, the  $N$ th element is the correlation at lag 0. Also notice the triangular pulse of the output that results when convolving two square pulses.

The `xcov` function estimates autocovariance and cross-covariance sequences. This function has the same options and evaluates the same sum as `xcorr`, but first removes the means of `x` and `y`.

## Bias and Normalization

An estimate of a quantity is *biased* if its expected value is not equal to the quantity it estimates. The expected value of the output of `xcorr` is

$$E\{R_{xy}(m)\} = (N - |m|)R_{xy}(m)$$

`xcorr` provides the unbiased estimate, dividing by  $N - |m|$ , when you specify an 'unbiased' flag after the input sequences.

```
xcorr(x,y,'unbiased')
```

Although this estimate is unbiased, the end points (near  $-(N-1)$  and  $N-1$ ) suffer from large variance because `xcorr` computes them using only a few data points. A possible trade-off is to simply divide by  $N$  using the 'biased' flag:

```
xcorr(x,y,'biased')
```

With this scheme, only the sample of the correlation at zero lag (the  $N$ th output element) is unbiased. This estimate is often more desirable than the unbiased one because it avoids random large variations at the end points of the correlation sequence.

`xcorr` provides one other normalization scheme. The syntax

```
xcorr(x,y,'coeff')
```

divides the output by  $\text{norm}(x) * \text{norm}(y)$  so that, for autocorrelations, the sample at zero lag is 1.

## Multiple Channels

For a multichannel signal, `xcorr` and `xcov` estimate the autocorrelation and cross-correlation and covariance sequences for all of the channels at once. If  $S$  is an  $M$ -by- $N$  signal matrix representing  $N$  channels in its columns, `xcorr(S)` returns a  $(2M-1)$ -by- $N^2$  matrix with the autocorrelations and cross-correlations of the channels of  $S$  in its  $N^2$  columns. If  $S$  is a three-channel signal

```
S = [s1 s2 s3]
```

then the result of `xcorr(S)` is organized as

```
R = [Rs1s1 Rs1s2 Rs1s3 Rs2s1 Rs2s2 Rs2s3 Rs3s1 Rs3s2 Rs3s3]
```

Two related functions, `cov` and `corrcoef`, are available in the standard MATLAB environment. They estimate covariance and normalized covariance respectively between the different channels at lag 0 and arrange them in a square matrix.



# Spectral Analysis

## In this section...

“Background Information” on page 6-5

“Spectral Estimation Method” on page 6-7

“Nonparametric Methods” on page 6-9

“Parametric Methods” on page 6-32

## Background Information

The goal of *spectral estimation* is to describe the distribution (over frequency) of the power contained in a signal, based on a finite set of data. Estimation of power spectra is useful in a variety of applications, including the detection of signals buried in wideband noise.

The *power spectral density* (PSD) of a stationary random process  $x_n$  is mathematically related to the autocorrelation sequence by the discrete-time Fourier transform. In terms of normalized frequency, this is given by

$$P_{xx}(\omega) = \frac{1}{2\pi} \sum_{m=-\infty}^{\infty} R_{xx}(m) e^{-j\omega m}$$

This can be written as a function of physical frequency  $f$  (e.g., in hertz) by using the relation  $\omega = 2\pi f/f_s$ , where  $f_s$  is the sampling frequency.

$$P_{xx}(f) = \frac{1}{f_s} \sum_{m=-\infty}^{\infty} R_{xx}(m) e^{-j2\pi m f/f_s}$$

The correlation sequence can be derived from the PSD by use of the inverse discrete-time Fourier transform:

$$R_{xx}(m) = \int_{-\pi}^{\pi} P_{xx}(\omega) e^{j\omega m} d\omega = \int_{-f_s/2}^{f_s/2} P_{xx}(f) e^{j2\pi m f/f_s} df$$

The average power of the sequence  $x_n$  over the entire Nyquist interval is represented by

$$R_{xx}(0) = \int_{-\pi}^{\pi} P_{xx}(\omega) d\omega = \int_{-f_s/2}^{f_s/2} P_{xx}(f) df$$

The average power of a signal over a particular frequency band  $[\omega_1, \omega_2]$ ,  $0 \leq \omega_1 \leq \omega_2 \leq \pi$ , can be found by integrating the PSD over that band:

$$\bar{P}_{[\omega_1, \omega_2]} = \int_{\omega_1}^{\omega_2} P_{xx}(\omega) d\omega = \int_{-\omega_2}^{-\omega_1} P_{xx}(\omega) d\omega$$

You can see from the above expression that  $P_{xx}(\omega)$  represents the power content of a signal in an *infinitesimal* frequency band, which is why it is called the power spectral *density*.

The units of the PSD are power (e.g., watts) per unit of frequency. In the case of  $P_{xx}(\omega)$ , this is watts/radian/sample or simply watts/radian. In the case of  $P_{xx}(f)$ , the units are watts/hertz. Integration of the PSD with respect to frequency yields units of watts, as expected for the average power.

For real-valued signals, the PSD is symmetric about DC, and thus  $P_{xx}(\omega)$  for  $0 \leq \omega \leq \pi$  is sufficient to completely characterize the PSD. However, to obtain the average power over the entire Nyquist interval, it is necessary to introduce the concept of the *one-sided* PSD.

The one-sided PSD is given by

$$P_{\text{onesided}}(\omega) = \begin{cases} 0 & -\pi \leq \omega < 0 \\ 2P_{xx}(\omega) & 0 \leq \omega \leq \pi \end{cases}$$

The average power of a signal over the frequency band,  $[\omega_1, \omega_2]$  with  $0 \leq \omega_1 \leq \omega_2 \leq \pi$ , can be computed using the one-sided PSD as

$$\bar{P}_{[\omega_1, \omega_2]} = \int_{\omega_1}^{\omega_2} P_{\text{onesided}}(\omega) d\omega$$

## Spectral Estimation Method

The various methods of spectrum estimation available in the toolbox are categorized as follows:

- Nonparametric methods
- Parametric methods
- Subspace methods

*Nonparametric methods* are those in which the PSD is estimated directly from the signal itself. The simplest such method is the *periodogram*. Other nonparametric techniques such as *Welch's method* [8], the *multitaper method (MTM)* reduce the variance of the periodogram.

*Parametric methods* are those in which the PSD is estimated from a signal that is assumed to be output of a linear system driven by white noise. Examples are the *Yule-Walker autoregressive (AR) method* and the *Burg method*. These methods estimate the PSD by first estimating the parameters (coefficients) of the linear system that hypothetically generates the signal. They tend to produce better results than classical nonparametric methods when the data length of the available signal is relatively short. Parametric methods also produce smoother estimates of the PSD than nonparametric methods, but are subject to error from model misspecification.

*Subspace methods*, also known as *high-resolution methods* or *super-resolution methods*, generate frequency component estimates for a signal based on an eigenanalysis or eigendecomposition of the autocorrelation matrix. Examples are the *multiple signal classification (MUSIC) method* or the *eigenvector (EV) method*. These methods are best suited for line spectra — that is, spectra of sinusoidal signals — and are effective in the detection of sinusoids buried in noise, especially when the signal to noise ratios are low. The subspace methods do not yield true PSD estimates: they do not preserve process power between the time and frequency domains, and the autocorrelation sequence cannot be recovered by taking the inverse Fourier transform of the frequency estimate.

All three categories of methods are listed in the table below with the corresponding toolbox function and spectrum object names. More information about each function is on the corresponding function reference page.

See “Parametric Modeling” on page 7-13 for details about `lpc` and other parametric estimation functions.

### Spectral Estimation Methods/Functions

Method	Description	Functions
Periodogram	Power spectral density estimate	<code>spectrum.periodogram</code> , <code>periodogram</code>
Welch	Averaged periodograms of overlapped, windowed signal sections	<code>spectrum.welch</code> , <code>pwelch</code> , <code>cpsd</code> , <code>tffestimate</code> , <code>mscohere</code>
Multitaper	Spectral estimate from combination of multiple orthogonal windows (or “tapers”)	<code>spectrum.mtm</code> , <code>pmtm</code>
Yule-Walker AR	Autoregressive (AR) spectral estimate of a time-series from its estimated autocorrelation function	<code>spectrum.yulear</code> , <code>pyulear</code>
Burg	Autoregressive (AR) spectral estimation of a time-series by minimization of linear prediction errors	<code>spectrum.burg</code> , <code>pburg</code>
Covariance	Autoregressive (AR) spectral estimation of a time-series by minimization of the forward prediction errors	<code>spectrum.cov</code> , <code>pcov</code>
Modified Covariance	Autoregressive (AR) spectral estimation of a time-series by minimization of the forward and backward prediction errors	<code>spectrum.mcov</code> , <code>pmcov</code>

### Spectral Estimation Methods/Functions (Continued)

Method	Description	Functions
MUSIC	Multiple signal classification	spectrum.music, pmusic
Eigenvector	Pseudospectrum estimate	spectrum.eigenvector, peig

### Nonparametric Methods

The following sections discuss the periodogram, modified periodogram, Welch, and multitaper methods of nonparametric estimation, along with the related CPSD function, transfer function estimate, and coherence function.

#### Periodogram

In general terms, one way of estimating the PSD of a process is to simply find the discrete-time Fourier transform of the samples of the process (usually done on a grid with an FFT) and appropriately scale the magnitude squared of the result. This estimate is called the *periodogram*.

The periodogram estimate of the PSD of a length- $L$  signal  $x_L[n]$  is

$$P_{xx}(f) = \frac{1}{LF_s} \left| \sum_{n=0}^{L-1} x_L(n) e^{-j2\pi fn/F_s} \right|^2$$

where  $F_s$  is the sampling frequency.

In practice, the actual computation of  $P_{xx}(f)$  can be performed only at a finite number of frequency points, and usually employs an FFT. Most implementations of the periodogram method compute the  $N$ -point PSD estimate at the frequencies

$$f_k = \frac{kF_s}{N} \quad k = 0, 1, \dots, N-1$$

In some cases, the computation of the periodogram via an FFT algorithm is more efficient if the number of frequencies is a power of two. Therefore it is not uncommon to pad the input signal with zeros to extend its length to a power of two.

As an example of the periodogram, consider the following 1001-element signal  $x_n$ , which consists of two sinusoids plus noise:

```
fs = 1000;           % Sampling frequency
t = (0:fs)/fs;      % One second worth of samples
A = [1 2];         % Sinusoid amplitudes (row vector)
f = [150;140];     % Sinusoid frequencies (column vector)
xn = A*sin(2*pi*f*t) + 0.1*randn(size(t));
```

---

**Note** The three last lines illustrate a convenient and general way to express the sum of sinusoids.

Together they are equivalent to  $x_n = \sin(2\pi*150*t) + 2*\sin(2\pi*140*t) + 0.1*\text{randn}(\text{size}(t))$ ;

---

The periodogram estimate of the PSD can be computed by creating a periodogram object. In this case, the data vector is multiplied by a Hamming window.

```
Hs = spectrum.periodogram('Hamming');
```

and a plot of the PSD estimate can be displayed with the `psd` method:

```
psd(Hs,xn,'Fs',fs,'NFFT',1024,'SpectrumType','onesided')
```

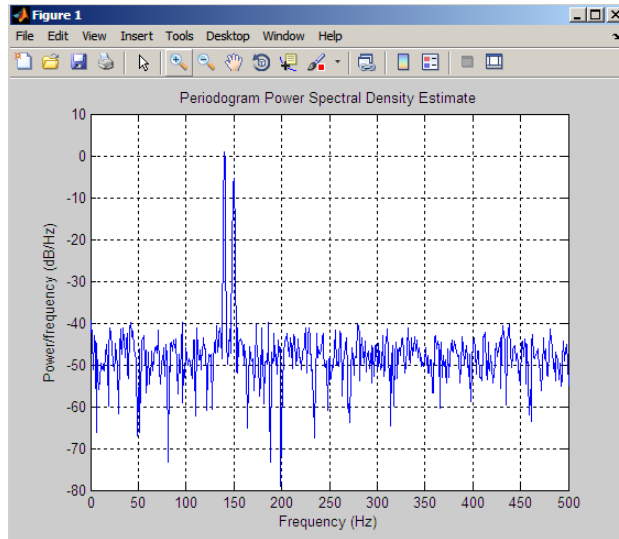

The average power can be computed by approximating the integral with the following sum:

```
Hdsp2= psd(Hs,xn,'Fs',fs,'NFFT',1024,'SpectrumType','twosided');
Pow = avgpower(Hdsp2)
```

You can also compute the average power from the one-sided PSD estimate:

```
Hdsp3= psd(Hs,xn,'Fs',fs,'NFFT',1024,'SpectrumType','onesided');
Pow = avgpower(Hdsp3)
```

**Algorithm.** `Spectrum.periodogram` computes and scales the output of the FFT to produce the power vs. frequency plot as follows. For a detailed example, see “Power Spectral Density Estimates Using FFT” on page 12-2.

- 1 For rapid and efficient processing, make the input signal length (`nfft`) equal to a power of 2 by padding it with zeros.

- 2 If the input signal is real-valued, the magnitude of the resulting FFT is symmetric with respect to zero frequency (DC). For an even-length FFT, only the first  $(1+nfft/2)$  points are unique. Determine the number of unique values and keep only those unique points.
- 3 Take the squared magnitudes of the unique FFT values. Scale the squared magnitudes (except for DC) by  $2F_s/N$ , where  $N$  is the length of signal *prior* to any zero padding. Scale the DC value by  $F_s/N$ .
- 4 Create a frequency vector from the number of unique points, the *nfft* and the sampling frequency.
- 5 Plot the resulting magnitude squared FFT vs. the frequency.

### Performance of the Periodogram

The following sections discuss the performance of the periodogram with regard to the issues of leakage, resolution, bias, and variance.

**Spectral Leakage.** Consider the PSD of a finite-length (length  $L$ ) signal  $x_L[n]$ , as discussed in the “Periodogram” on page 6-9 section. It is frequently useful to interpret  $x_L[n]$  as the result of multiplying an infinite signal,  $x[n]$ , by a finite-length rectangular window,  $w_R[n]$ :

$$x_L[n] = x[n]w_R[n].$$

Because multiplication in the time domain corresponds to convolution in the frequency domain, the expected value of the periodogram in the frequency domain is:

$$E\{P_{xx}(f)\} = \frac{1}{F_s} \int_{-F_s/2}^{F_s/2} \frac{\sin^2(L\pi(f-f')/F_s)}{L \sin^2(\pi(f-f')/F_s)} P_{xx}(f') df',$$

showing that the expected value of the periodogram is the convolution of the true PSD with the square of the Dirichlet kernel.

The effect of the convolution is best understood for sinusoidal data. Suppose that  $x[n]$  is composed of a sum of  $M$  complex sinusoids:



$$x(n) = \sum_{k=1}^N A_k e^{j\omega_k n}$$

Its spectrum is

$$X(\omega) = \sum_{k=1}^N A_k \delta(\omega - \omega_k)$$

which for a finite-length sequence becomes

$$X(\omega) = \int_{-\pi}^{\pi} \left( \sum_{k=1}^N A_k \delta(\omega - \omega_k) \right) W_R(\omega - \omega_k) d\omega = \sum_{k=1}^N A_k W_R(\omega - \omega_k)$$

The preceding equation is equal to:

$$X(\omega) = \sum_{k=1}^N A_k W_R(\omega - \omega_k)$$

So in the spectrum of the finite-length signal, the Dirac deltas have been replaced by terms of the form  $W_R(\omega - \omega_k)$ , which corresponds to the frequency response of a rectangular window centered on the frequency  $\omega_k$ .

The frequency response of a rectangular window has the shape of a sinc signal, as shown below.

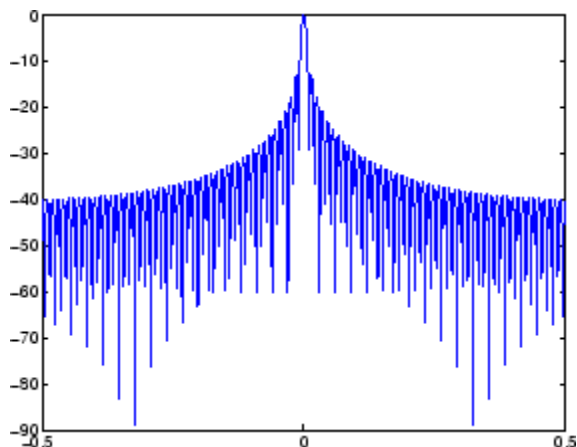

The plot displays a main lobe and several side lobes, the largest of which is approximately 13.5 dB below the mainlobe peak. These lobes account for the effect known as *spectral leakage*. While the infinite-length signal has its power concentrated exactly at the discrete frequency points  $f_k$ , the windowed (or truncated) signal has a continuum of power “leaked” around the discrete frequency points  $f_k$ .

Because the frequency response of a short rectangular window is a much poorer approximation to the Dirac delta function than that of a longer window, spectral leakage is especially evident when data records are short. Consider the following sequence of 100 samples:

```
fs = 1000;                % Sampling frequency
t = (0:fs/10)/fs;        % One-tenth second worth of samples
A = [1 2];               % Sinusoid amplitudes
f = [150;140];           % Sinusoid frequencies
xn = A*sin(2*pi*f*t) + 0.1*randn(size(t));
Hs = spectrum.periodogram;
psd(Hs,xn,'Fs',fs,'NFFT',1024)
```

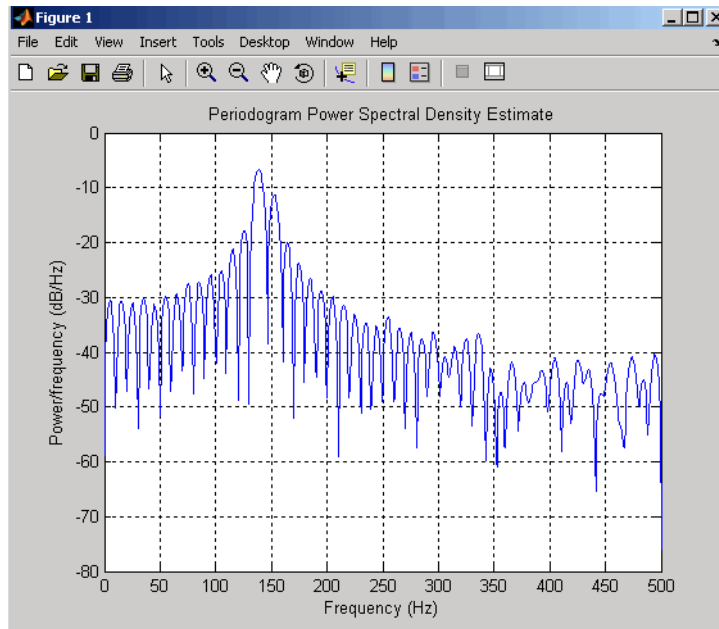

It is important to note that the effect of spectral leakage is contingent solely on the length of the data record. It is *not* a consequence of the fact that the periodogram is computed at a finite number of frequency samples.

**Resolution.** *Resolution* refers to the ability to discriminate spectral features, and is a key concept on the analysis of spectral estimator performance.

In order to resolve two sinusoids that are relatively close together in frequency, it is necessary for the difference between the two frequencies to be greater than the width of the mainlobe of the leaked spectra for either one of these sinusoids. The mainlobe width is defined to be the width of the mainlobe at the point where the power is half the peak mainlobe power (i.e., 3 dB width). This width is approximately equal to  $f_s / L$ .

In other words, for two sinusoids of frequencies  $f_1$  and  $f_2$ , the resolvability condition requires that

$$(f_2 - f_1) > \frac{f_s}{L}$$

In the example above, where two sinusoids are separated by only 10 Hz, the data record must be greater than 100 samples to allow resolution of two distinct sinusoids by a periodogram.

Consider a case where this criterion is not met, as for the sequence of 67 samples below:

```
fs = 1000; % Sampling frequency
t = (0:fs/15)./fs; % 67 samples
A = [1 2]; % Sinusoid amplitudes
f = [150;140]; % Sinusoid frequencies
xn = A*sin(2*pi*f*t) + 0.1*randn(size(t));
Hs=spectrum.periodogram;
psd(Hs,xn,'Fs',fs,'NFFT',1024)
```

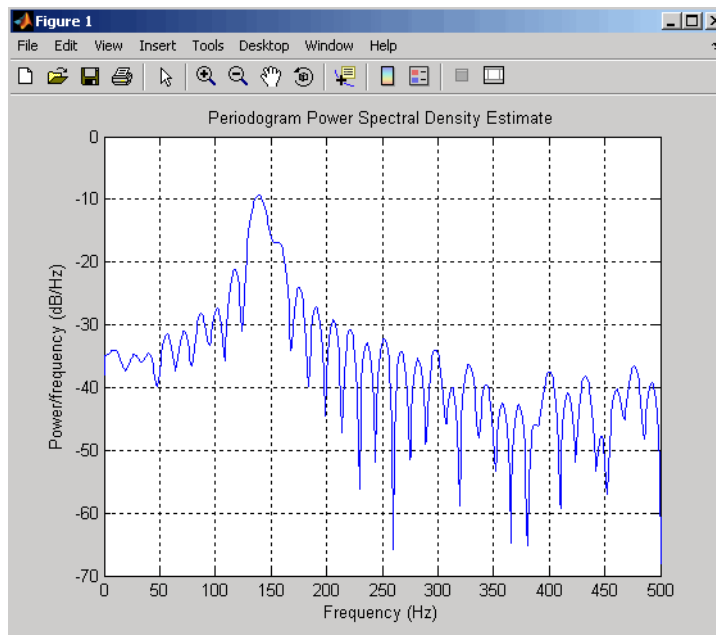

The above discussion about resolution did not consider the effects of noise since the signal-to-noise ratio (SNR) has been relatively high thus far. When the SNR is low, true spectral features are much harder to distinguish, and

noise artifacts appear in spectral estimates based on the periodogram. The example below illustrates this:

```
fs = 1000; % Sampling frequency
t = (0:fs/10)./fs; % One-tenth second worth of samples
A = [1 2]; % Sinusoid amplitudes
f = [150;140]; % Sinusoid frequencies
xn = A*sin(2*pi*f*t) + 2*randn(size(t));
Hs=spectrum.periodogram;
psd(Hs,xn,'Fs',fs,'NFFT',1024)
```

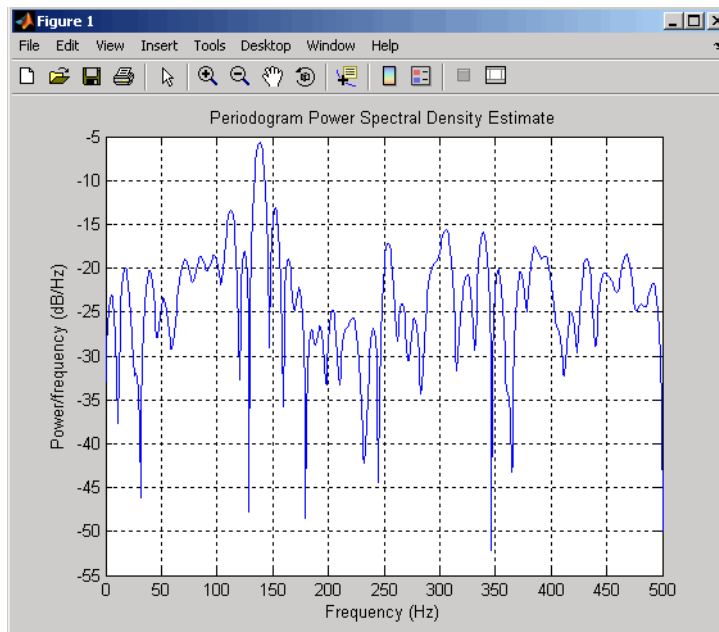

**Bias of the Periodogram.** The periodogram is a biased estimator of the PSD. Its expected value was previously shown to be:

$$E\{P_{xx}(f)\} = \frac{1}{F_s} \int_{-F_s/2}^{F_s/2} \frac{\sin^2(L\pi(f-f')/F_s)}{L \sin^2(\pi(f-f')/F_s)} P_{xx}(f') df',$$

The periodogram is asymptotically unbiased, which is evident from the earlier observation that as the data record length tends to infinity, the frequency response of the rectangular window more closely approximates the Dirac delta function. However, in some cases the periodogram is a poor estimator of the PSD even when the data record is long. This is due to the variance of the periodogram, as explained below.

**Variance of the Periodogram.** The variance of the periodogram can be shown to be:

$$\text{Var}(P_{xx}(f)) = \begin{cases} P_{xx}^2(f) & 0 < f < F_s / 2 \\ 2P_{xx}^2(f) & f = 0 \text{ or } f = F_s / 2 \end{cases}$$

which indicates that the variance does not tend to zero as the data length  $L$  tends to infinity. In statistical terms, the periodogram is not a consistent estimator of the PSD. Nevertheless, the periodogram can be a useful tool for spectral estimation in situations where the SNR is high, and especially if the data record is long.

### The Modified Periodogram

The *modified periodogram* windows the time-domain signal prior to computing the DFT in order to smooth the edges of the signal. This has the effect of reducing the height of the sidelobes or spectral leakage. This phenomenon gives rise to the interpretation of sidelobes as spurious frequencies introduced into the signal by the abrupt truncation that occurs when a rectangular window is used. For nonrectangular windows, the end points of the truncated signal are attenuated smoothly, and hence the spurious frequencies introduced are much less severe. On the other hand, nonrectangular windows also broaden the mainlobe, which results in a reduction of resolution.

`spectrum.periodogram` allows you to compute a modified periodogram by specifying the window to be used on the data. For example, compare a default rectangular window and a Hamming window:

```
fs = 1000;           % Sampling frequency
t = (0:fs/10)./fs;  % One-tenth second worth of samples
A = [1 2];          % Sinusoid amplitudes
```

```
f = [150;140]; % Sinusoid frequencies
xn = A*sin(2*pi*f*t) + 0.1*randn(size(t));
Hrect = spectrum.periodogram;
psd(Hrect,xn,'Fs',fs,'NFFT',1024);
```

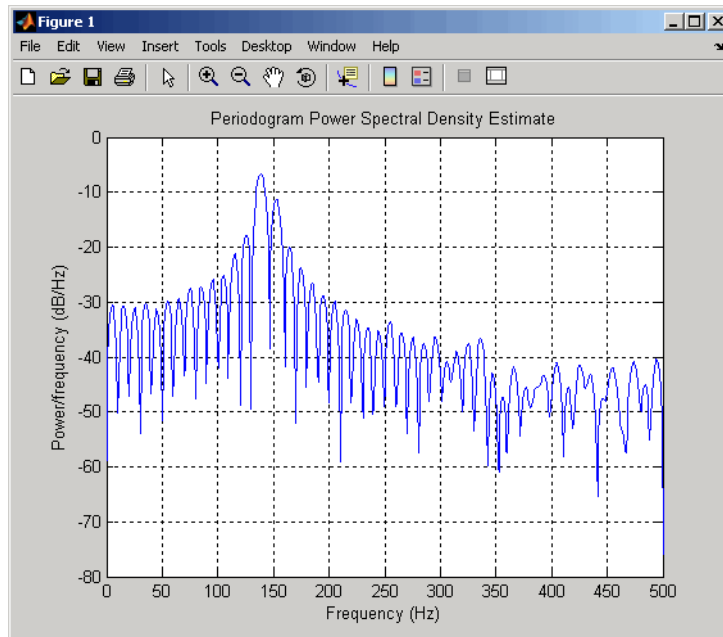

```
Hhamm = spectrum.periodogram('Hamming');
psd(Hhamm,xn,'Fs',fs,'NFFT',1024);
```

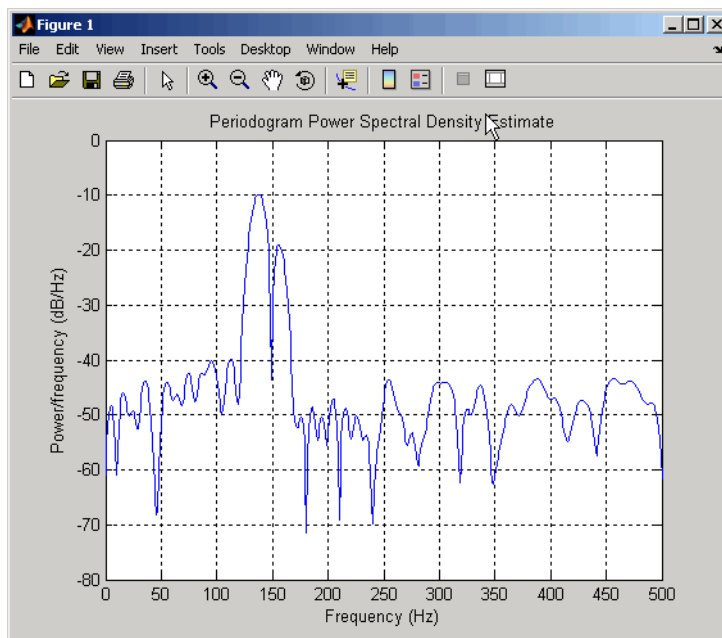

You can verify that although the sidelobes are much less evident in the Hamming-windowed periodogram, the two main peaks are wider. In fact, the 3 dB width of the mainlobe corresponding to a Hamming window is approximately twice that of a rectangular window. Hence, for a fixed data length, the PSD resolution attainable with a Hamming window is approximately half that attainable with a rectangular window. The competing interests of mainlobe width and sidelobe height can be resolved to some extent by using variable windows such as the Kaiser window.

Nonrectangular windowing affects the average power of a signal because some of the time samples are attenuated when multiplied by the window. To compensate for this, `spectrum.periodogram` and `spectrum.welch` normalize the window to have an average power of unity. This ensures that the measured average power is generally independent of window choice. If the frequency components are not well resolved by the PSD estimators, the window choice does affect the average power.



The modified periodogram estimate of the PSD is

$$\hat{P}_{xx}(f) = \frac{|X(f)|^2}{FsLU}$$

where  $U$  is the window normalization constant.

$$U = \frac{1}{L} \sum_{n=0}^{N-1} |w(n)|^2.$$

For large values of  $L$ ,  $U$  tends to become independent of window length. The addition of  $U$  as a normalization constant ensures that the modified periodogram is asymptotically unbiased.

### Welch's Method

An improved estimator of the PSD is the one proposed by Welch [8]. The method consists of dividing the time series data into (possibly overlapping) segments, computing a modified periodogram of each segment, and then averaging the PSD estimates. The result is Welch's PSD estimate. Welch's method is implemented in the toolbox by the `spectrum.welch` object or `pwelch` function

The averaging of modified periodograms tends to decrease the variance of the estimate relative to a single periodogram estimate of the entire data record. Although overlap between segments introduces redundant information, this effect is diminished by the use of a nonrectangular window, which reduces the importance or *weight* given to the end samples of segments (the samples that overlap).

However, as mentioned above, the combined use of short data records and nonrectangular windows results in reduced resolution of the estimator. In summary, there is a trade-off between variance reduction and resolution. One can manipulate the parameters in Welch's method to obtain improved estimates relative to the periodogram, especially when the SNR is low. This is illustrated in the following example.

Consider an original signal consisting of 301 samples:

```
fs = 1000;           % Sampling frequency
t = (0:0.3*fs)./fs; % 301 samples
A = [2 8];          % Sinusoid amplitudes (row vector)
f = [150;140];      % Sinusoid frequencies (column vector)
xn = A*sin(2*pi*f*t) + 5*randn(size(t));
Hs = spectrum.periodogram('rectangular');
psd(Hs,xn,'Fs',fs,'NFFT',1024);
```

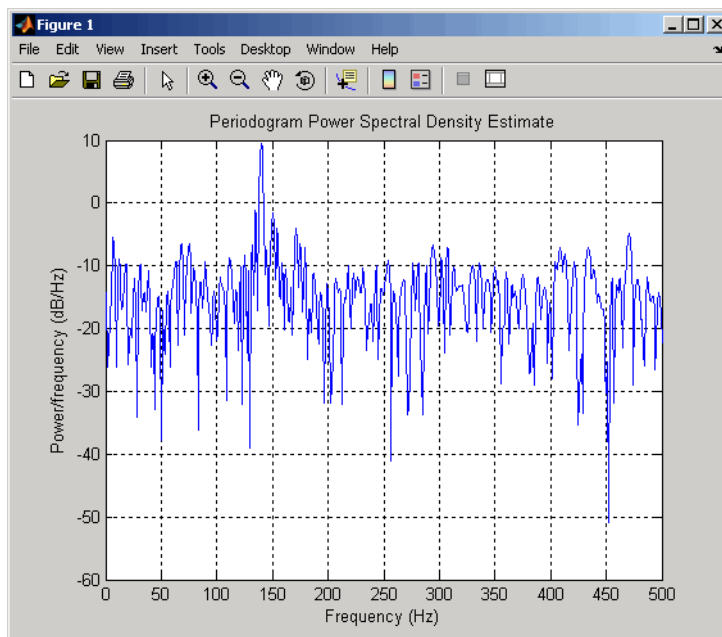

We can obtain Welch's spectral estimate for 3 segments with 50% overlap with

```
Hs = spectrum.welch('rectangular',150,50);
psd(Hs,xn,'Fs',fs,'NFFT',512);
```

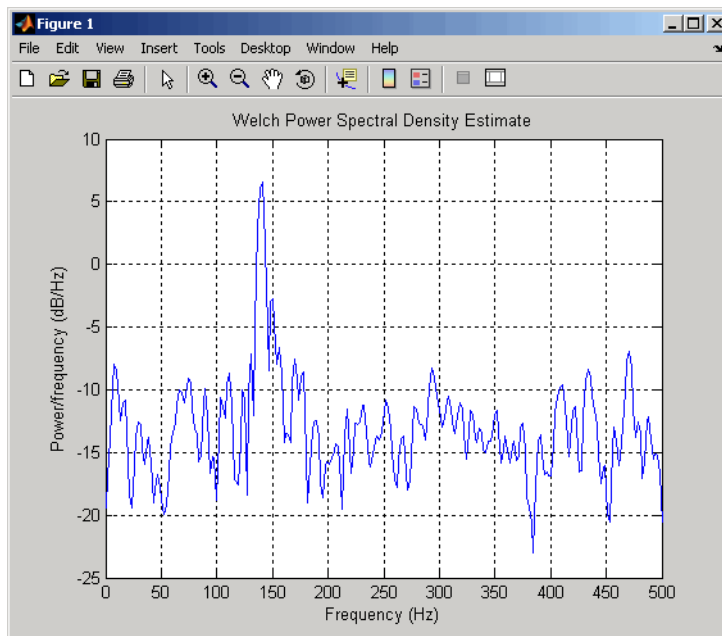

In the periodogram above, noise and the leakage make one of the sinusoids essentially indistinguishable from the artificial peaks. In contrast, although the PSD produced by Welch's method has wider peaks, you can still distinguish the two sinusoids, which stand out from the "noise floor."

However, if we try to reduce the variance further, the loss of resolution causes one of the sinusoids to be lost altogether:

```
Hs = spectrum.welch('rectangular',100,75);
psd(Hs,xn,'Fs','fs','NFFT',512);
```

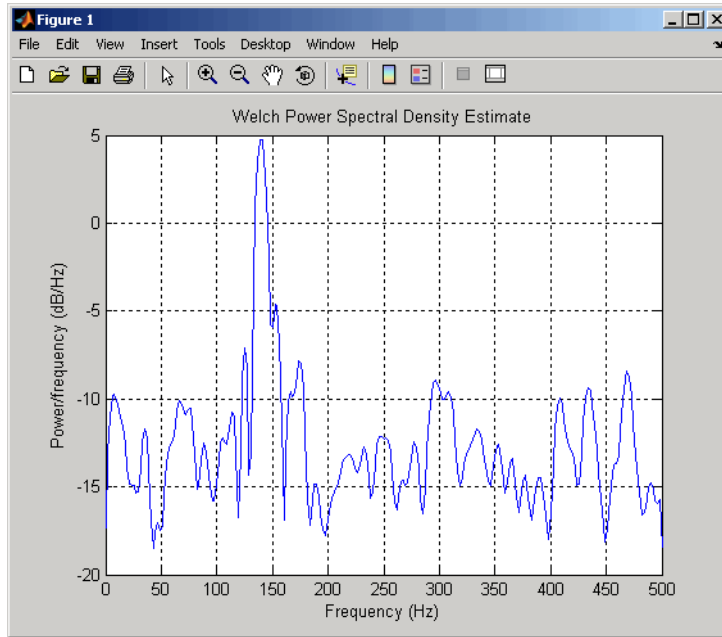

For a more detailed discussion of Welch's method of PSD estimation, see Kay [2] and Welch [8].

### Bias and Normalization in Welch's Method

Welch's method yields a biased estimator of the PSD. The expected value of the PSD estimate is:

$$E\{P_{\text{Welch}}(f)\} = \frac{1}{F_s L U} \int_{-F_s/2}^{F_s/2} |W(f-f')|^2 P_{xx}(f') df'$$

where  $L$  is the length of the data segments,  $U$  is the same normalization constant present in the definition of the modified periodogram, and  $W(f)$  is the Fourier transform of the window function. As is the case for all periodograms, Welch's estimator is asymptotically unbiased. For a fixed length data record,

the bias of Welch's estimate is larger than that of the periodogram because the length of the segments is less than the length of the entire data sample.

The variance of Welch's estimator is difficult to compute because it depends on both the window used and the amount of overlap between segments. Basically, the variance is inversely proportional to the number of segments whose modified periodograms are being averaged.

### **Multitaper Method**

The periodogram can be interpreted as filtering a length  $L$  signal,  $x_L[n]$ , through a filter bank (a set of filters in parallel) of  $L$  FIR bandpass filters. The 3 dB bandwidth of each of these bandpass filters can be shown to be approximately equal to  $f_s / L$ . The magnitude response of each one of these bandpass filters resembles that of the rectangular window discussed in "Spectral Leakage" on page 6-12. The periodogram can thus be viewed as a computation of the power of each filtered signal (i.e., the output of each bandpass filter) that uses just one sample of each filtered signal and assumes that the PSD of  $x_L[n]$  is constant over the bandwidth of each bandpass filter.

As the length of the signal increases, the bandwidth of each bandpass filter decreases, making it a more selective filter, and improving the approximation of constant PSD over the bandwidth of the filter. This provides another interpretation of why the PSD estimate of the periodogram improves as the length of the signal increases. However, there are two factors apparent from this standpoint that compromise the accuracy of the periodogram estimate. First, the rectangular window yields a poor bandpass filter. Second, the computation of the power at the output of each bandpass filter relies on a single sample of the output signal, producing a very crude approximation.

Welch's method can be given a similar interpretation in terms of a filter bank. In Welch's implementation, several samples are used to compute the output power, resulting in reduced variance of the estimate. On the other hand, the bandwidth of each bandpass filter is larger than that corresponding to the periodogram method, which results in a loss of resolution. The filter bank model thus provides a new interpretation of the compromise between variance and resolution.

Thompson's *multitaper method* (MTM) builds on these results to provide an improved PSD estimate. Instead of using bandpass filters that are essentially

rectangular windows (as in the periodogram method), the MTM method uses a bank of optimal bandpass filters to compute the estimate. These optimal FIR filters are derived from a set of sequences known as *discrete prolate spheroidal sequences* (DPSSs, also known as *Slepian sequences*).

In addition, the MTM method provides a time-bandwidth parameter with which to balance the variance and resolution. This parameter is given by the time-bandwidth product,  $NW$  and it is directly related to the number of tapers used to compute the spectrum. There are always  $2*NW-1$  tapers used to form the estimate. This means that, as  $NW$  increases, there are more estimates of the power spectrum, and the variance of the estimate decreases. However, the bandwidth of each taper is also proportional to  $NW$ , so as  $NW$  increases, each estimate exhibits more spectral leakage (i.e., wider peaks) and the overall spectral estimate is more biased. For each data set, there is usually a value for  $NW$  that allows an optimal trade-off between bias and variance.

The Signal Processing Toolbox function that implements the MTM method is `pmtm` and the object that implements it is `spectrum.mtm`. Use `spectrum.mtm` to compute the PSD of  $x_n$  from the previous examples:

```
fs = 1000;           % Sampling frequency
t = (0:fs)/fs;      % One second worth of samples
A = [1 2];          % Sinusoid amplitudes
f = [150;140];      % Sinusoid frequencies
xn = A*sin(2*pi*f*t) + 0.1*randn(size(t));
Hs1 = spectrum.mtm(4, 'adapt');
psd(Hs1, xn, 'Fs', fs, 'NFFT', 1024)
```

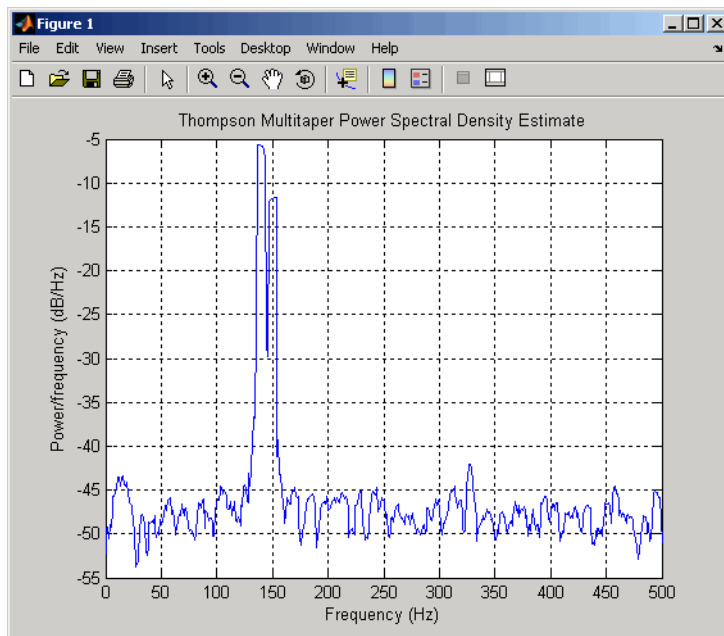

By lowering the time-bandwidth product, you can increase the resolution at the expense of larger variance:

```
Hs2 = spectrum.mtm(3/2, 'adapt');
psd(Hs2, xn, 'Fs', fs, 'NFFT', 1024)
```

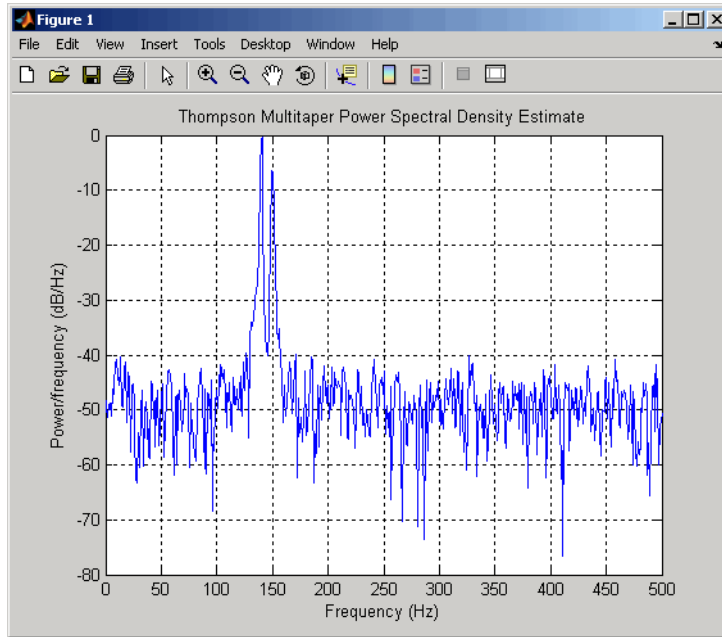

Note that the average power is conserved in both cases:

```
Hs1p = psd(Hs1, xn, 'Fs', fs, 'NFFT', 1024);
Pow1 = avgpower(Hs1p)
Hs2p = psd(Hs2, xn, 'Fs', fs, 'NFFT', 1024);
Pow2 = avgpower(Hs2p)
```

This method is more computationally expensive than Welch's method due to the cost of computing the discrete prolate spheroidal sequences. For long data series (10,000 points or more), it is useful to compute the DPSSs once and save them in a MAT-file. `dpsssave`, `dpssload`, `dpssdir`, and `dpsscld` are provided to keep a database of saved DPSSs in the MAT-file `dpss.mat`.



## Cross-Spectral Density Function

The PSD is a special case of the *cross spectral density (CPSD)* function, defined between two signals  $x_n$  and  $y_n$  as

$$P_{xy}(\omega) = \frac{1}{2\pi} \sum_{m=-\infty}^{\infty} R_{xy}(m)e^{-j\omega m}$$

As is the case for the correlation and covariance sequences, the toolbox *estimates* the PSD and CPSD because signal lengths are finite.

To estimate the cross-spectral density of two equal length signals  $x$  and  $y$  using Welch's method, the `cpsd` function forms the periodogram as the product of the FFT of  $x$  and the conjugate of the FFT of  $y$ . Unlike the real-valued PSD, the CPSD is a complex function. `cpsd` handles the sectioning and windowing of  $x$  and  $y$  in the same way as the `pwelch` function:

```
Sxy = cpsd(x,y,nwin,noverlap,nfft,fs)
```

## Transfer Function Estimate

One application of Welch's method is nonparametric system identification. Assume that  $H$  is a linear, time invariant system, and  $x(n)$  and  $y(n)$  are the input to and output of  $H$ , respectively. Then the power spectrum of  $x(n)$  is related to the CPSD of  $x(n)$  and  $y(n)$  by

$$P_{yx}(\omega) = H(\omega)P_{xx}(\omega)$$

An estimate of the transfer function between  $x(n)$  and  $y(n)$  is

$$\hat{H}(\omega) = \frac{\hat{P}_{yx}(\omega)}{\hat{P}_{xx}(\omega)}$$

This method estimates both magnitude and phase information. The `tfestimate` function uses Welch's method to compute the CPSD and power spectrum, and then forms their quotient for the transfer function estimate. Use `tfestimate` the same way that you use the `cpsd` function.

Filter the signal  $x_n$  with an FIR filter, then plot the actual magnitude response and the estimated response:

```
h = ones(1,10)/10;           % Moving-average filter
yn = filter(h,1,xn);
[HEST,f] = tfestimate(xn,yn,256,128,256,fs);
H = freqz(h,1,f,fs);
subplot(2,1,1); plot(f,abs(H));
title('Actual Transfer Function Magnitude');
subplot(2,1,2); plot(f,abs(HEST));
title('Transfer Function Magnitude Estimate');
xlabel('Frequency (Hz)');
```

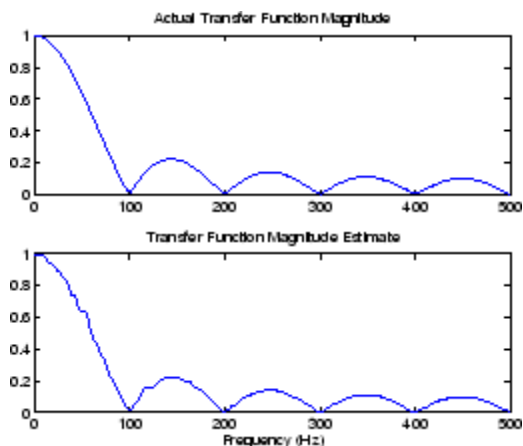

## Coherence Function

The magnitude-squared coherence between two signals  $x(n)$  and  $y(n)$  is

$$C_{xy}(\omega) = \frac{|P_{xy}(\omega)|^2}{P_{xx}(\omega)P_{yy}(\omega)}$$

This quotient is a real number between 0 and 1 that measures the correlation between  $x(n)$  and  $y(n)$  at the frequency  $\omega$ .

The `mscohere` function takes sequences `x` and `y`, computes their power spectra and CPSD, and returns the quotient of the magnitude squared of the CPSD and the product of the power spectra. Its options and operation are similar to the `cpsd` and `tfestimate` functions.

The coherence function of `xn` and the filter output `yn` versus frequency is

```
mscohere(xn, yn, 256, 128, 256, fs)
```

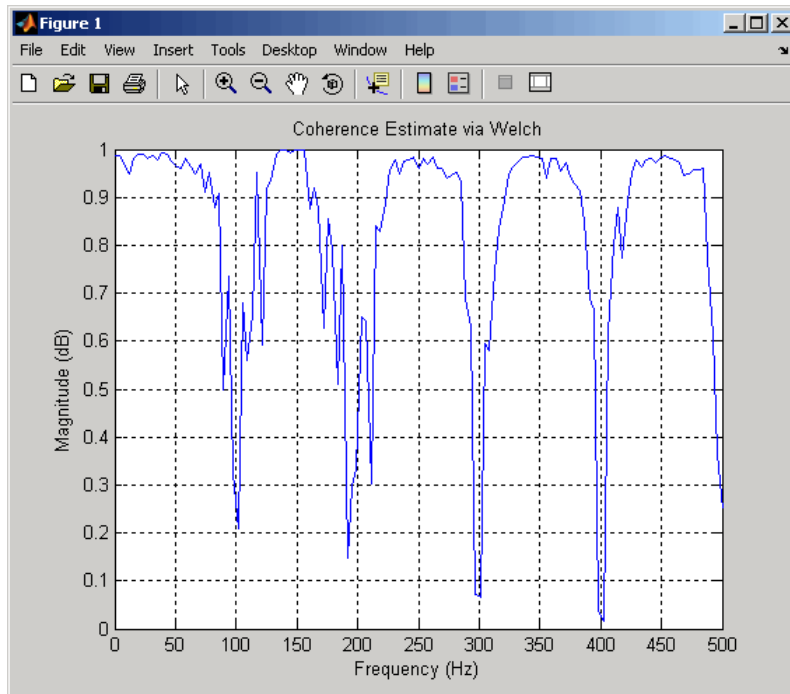

If the input sequence length `nfft`, window length `window`, and the number of overlapping data points in a window `numoverlap`, are such that `mscohere` operates on only a single record, the function returns all ones. This is because the coherence function for linearly dependent data is one.

## Parametric Methods

Parametric methods can yield higher resolutions than nonparametric methods in cases when the signal length is short. These methods use a different approach to spectral estimation; instead of trying to estimate the PSD directly from the data, they *model* the data as the output of a linear system driven by white noise, and then attempt to estimate the parameters of that linear system.

The most commonly used linear system model is the *all-pole model*, a filter with all of its zeroes at the origin in the  $z$ -plane. The output of such a filter for white noise input is an autoregressive (AR) process. For this reason, these methods are sometimes referred to as *AR methods* of spectral estimation.

The AR methods tend to adequately describe spectra of data that is “peaky,” that is, data whose PSD is large at certain frequencies. The data in many practical applications (such as speech) tends to have “peaky spectra” so that AR models are often useful. In addition, the AR models lead to a system of linear equations which is relatively simple to solve.

Signal Processing Toolbox AR methods for spectral estimation include:

- Yule-Walker AR method (autocorrelation method)
- Burg method
- Covariance method
- Modified covariance method

All AR methods yield a PSD estimate given by

$$\hat{P}(f) = \frac{1}{F_s} \frac{p}{\left| 1 - \sum_{k=1}^p \hat{a}_p(k) e^{-j2\pi k f / F_s} \right|^2}$$

The different AR methods estimate the parameters slightly differently, yielding different PSD estimates. The following table provides a summary of the different AR methods.

**AR Methods**

	<b>Burg</b>	<b>Covariance</b>	<b>Modified Covariance</b>	<b>Yule-Walker</b>
<b>Characteristics</b>	Does not apply window to data	Does not apply window to data	Does not apply window to data	Applies window to data
	Minimizes the forward and backward prediction errors in the least squares sense, with the AR coefficients constrained to satisfy the L-D recursion	Minimizes the forward prediction error in the least squares sense	Minimizes the forward and backward prediction errors in the least squares sense	Minimizes the forward prediction error in the least squares sense (also called “Autocorrelation method”)
<b>Advantages</b>	High resolution for short data records	Better resolution than Y-W for short data records (more accurate estimates)	High resolution for short data records	Performs as well as other methods for large data records
	Always produces a stable model	Able to extract frequencies from data consisting of $p$ or more pure sinusoids	Able to extract frequencies from data consisting of $p$ or more pure sinusoids Does not suffer spectral line-splitting	Always produces a stable model

**AR Methods (Continued)**

	<b>Burg</b>	<b>Covariance</b>	<b>Modified Covariance</b>	<b>Yule-Walker</b>
<b>Disadvantages</b>	Peak locations highly dependent on initial phase	May produce unstable models	May produce unstable models	Performs relatively poorly for short data records
	May suffer spectral line-splitting for sinusoids in noise, or when order is very large	Frequency bias for estimates of sinusoids in noise	Peak locations slightly dependent on initial phase	Frequency bias for estimates of sinusoids in noise
	Frequency bias for estimates of sinusoids in noise		Minor frequency bias for estimates of sinusoids in noise	
<b>Conditions for Nonsingularity</b>		Order must be less than or equal to half the input frame size	Order must be less than or equal to 2/3 the input frame size	Because of the biased estimate, the autocorrelation matrix is guaranteed to positive-definite, hence nonsingular

**Yule-Walker AR Method**

The *Yule-Walker AR method* of spectral estimation computes the AR parameters by solving the following linear system, which give the Yule-Walker equations in matrix form:

$$\begin{pmatrix} r(0) & r^*(1) & \dots & r^*(p-1) \\ r(1) & r(0) & \dots & r^*(p-2) \\ \vdots & \vdots & \ddots & \vdots \\ r(p-1) & r(p-2) & \dots & r(0) \end{pmatrix} \begin{pmatrix} a(1) \\ a(2) \\ \dots \\ a(p) \end{pmatrix} = \begin{pmatrix} r(1) \\ r(2) \\ \dots \\ r(p) \end{pmatrix}$$

In practice, the biased estimate of the autocorrelation is used for the unknown true autocorrelation. The Yule-Walker AR method produces the same results as a maximum entropy estimator. For more information, see page 155 of item [2] in the “Selected Bibliography” on page 6-46.

The use of a biased estimate of the autocorrelation function ensures that the autocorrelation matrix above is positive definite. Hence, the matrix is invertible and a solution is guaranteed to exist. Moreover, the AR parameters thus computed always result in a stable all-pole model. The Yule-Walker equations can be solved efficiently via Levinson’s algorithm, which takes advantage of the Hermitian Toeplitz structure of the autocorrelation matrix.

The toolbox object `spectrum.yulear` and function `pyulear` implement the Yule-Walker AR method.

For example, compare the spectrum of a speech signal using Welch’s method and the Yule-Walker AR method:

```
load mtlb
Hwelch = spectrum.welch('hamming',256,50);
psd(Hwelch,mtlb,'Fs',Fs,'NFFT',1024)
```

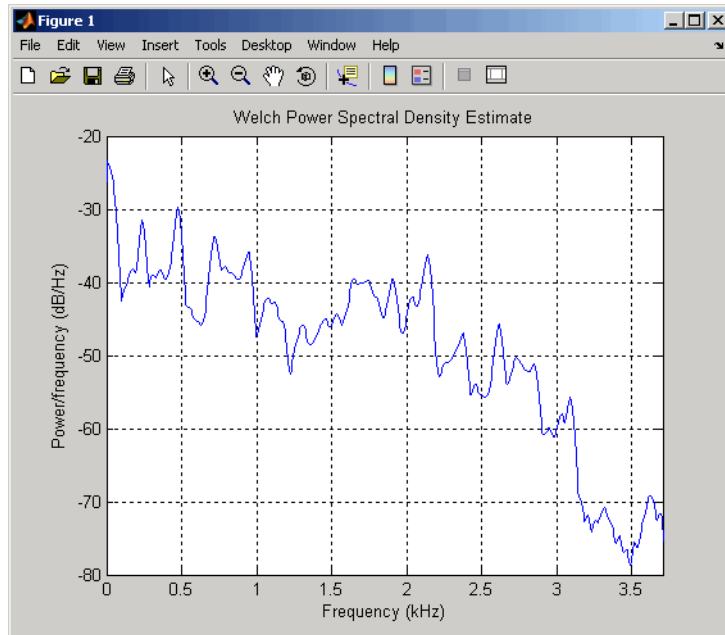



```
Hyulear = spectrum.yulear(14);
psd(Hyulear,mtlb,'Fs',Fs,'NFFT',1024)
```

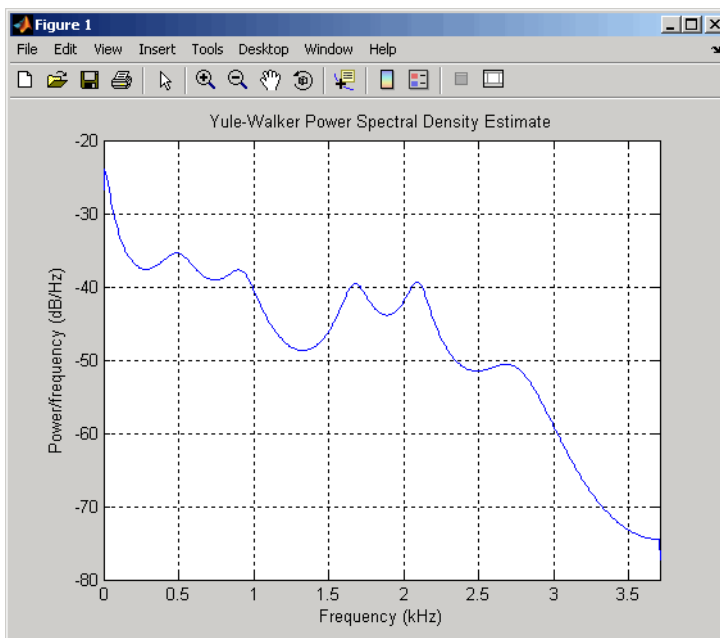

The Yule-Walker AR spectrum is smoother than the periodogram because of the simple underlying all-pole model.

### Burg Method

The Burg method for AR spectral estimation is based on minimizing the forward and backward prediction errors while satisfying the Levinson-Durbin recursion (see Marple [3], Chapter 7, and Proakis [6], Section 12.3.3). In contrast to other AR estimation methods, the Burg method avoids calculating the autocorrelation function, and instead estimates the reflection coefficients directly.

The primary advantages of the Burg method are resolving closely spaced sinusoids in signals with low noise levels, and estimating short data records, in which case the AR power spectral density estimates are very close to the

true values. In addition, the Burg method ensures a stable AR model and is computationally efficient.

The accuracy of the Burg method is lower for high-order models, long data records, and high signal-to-noise ratios (which can cause *line splitting*, or the generation of extraneous peaks in the spectrum estimate). The spectral density estimate computed by the Burg method is also susceptible to frequency shifts (relative to the true frequency) resulting from the initial phase of noisy sinusoidal signals. This effect is magnified when analyzing short data sequences.

The toolbox object `spectrum.burg` and function `pburg` implement the Burg method. Compare the spectrum of the speech signal generated by both the Burg method and the Yule-Walker AR method. They are very similar for large signal lengths:

```
load mtlb
Hburg = spectrum.burg(14);      % 14th order model
psd(Hburg,mtlb(1:512), 'Fs',Fs, 'NFFT',1024)
```

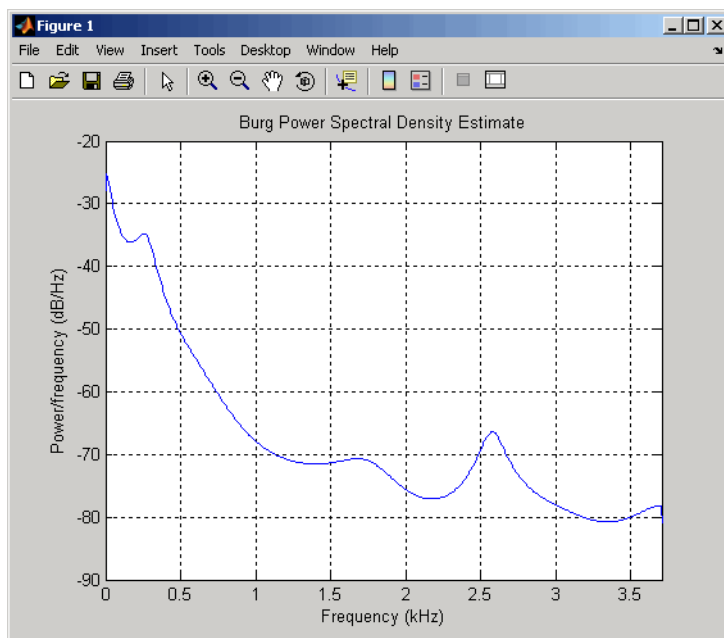

```
Hyulear = spectrum.yulear(14);           % 14th order model
psd(Hyulear,mtlb(1:512),'Fs',Fs,'NFFT',1024)
```

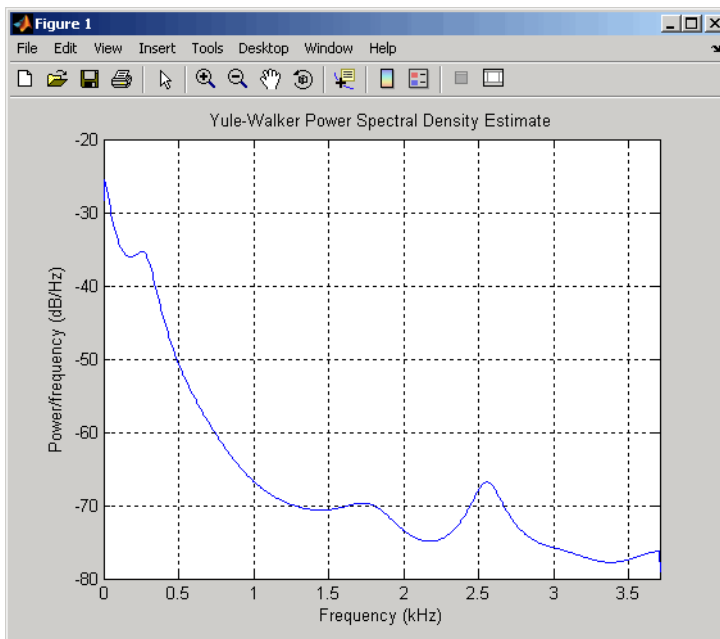

Compare the spectrum of a noisy signal computed using the Burg method and the Welch method:

```
fs = 1000;           % Sampling frequency
t = (0:fs)/fs;      % One second worth of samples
A = [1 2];          % Sinusoid amplitudes
f = [150;140];      % Sinusoid frequencies
xn = A*sin(2*pi*f*t) + 0.1*randn(size(t));
Hwelch = spectrum.welch('hamming',256,50);
psd(Hwelch,xn,'Fs',fs,'NFFT',1024)
```

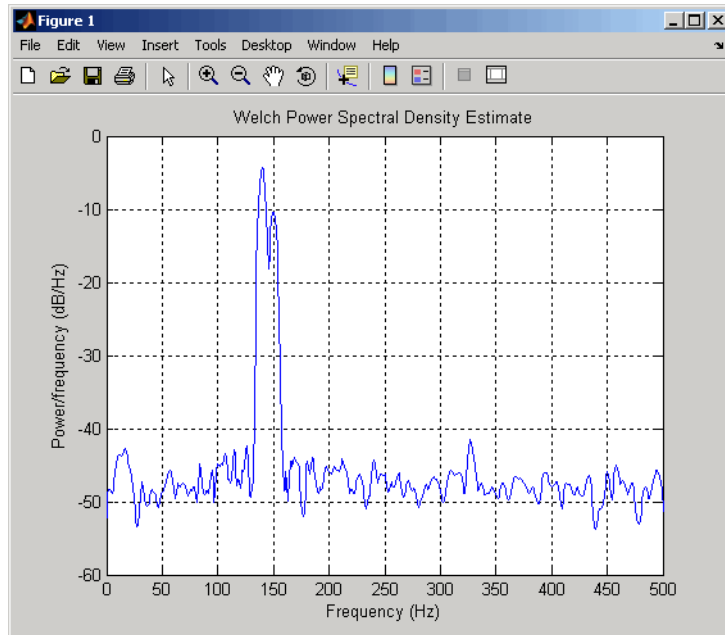

```
Hburg = spectrum.burg(14);
psd(Hburg,xn,'Fs',fs,'NFFT',1024)
```

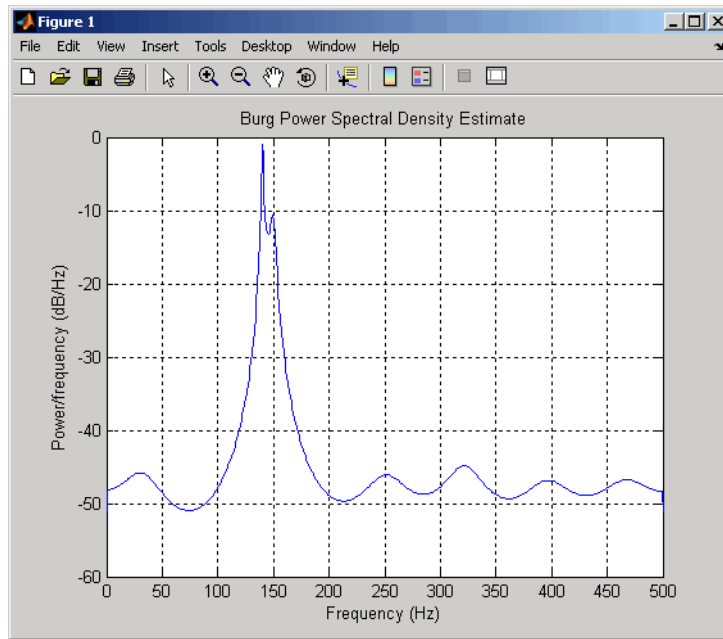

Note that, as the model order for the Burg method is reduced, a frequency shift due to the initial phase of the sinusoids will become apparent.

### Covariance and Modified Covariance Methods

The covariance method for AR spectral estimation is based on minimizing the forward prediction error. The modified covariance method is based on minimizing the forward and backward prediction errors. The toolbox object `spectrum.cov` and function `pcov`, and object `spectrum.mcov` and function `pmcov` implement the respective methods.

Compare the spectrum of the speech signal generated by both the covariance method and the modified covariance method. They are nearly identical, even for a short signal length:

```
load mtlb
Hcov = spectrum.cov(14);           % 14th order model
psd(Hcov,mtlb(1:64),'Fs',Fs,'NFFT',1024)
```

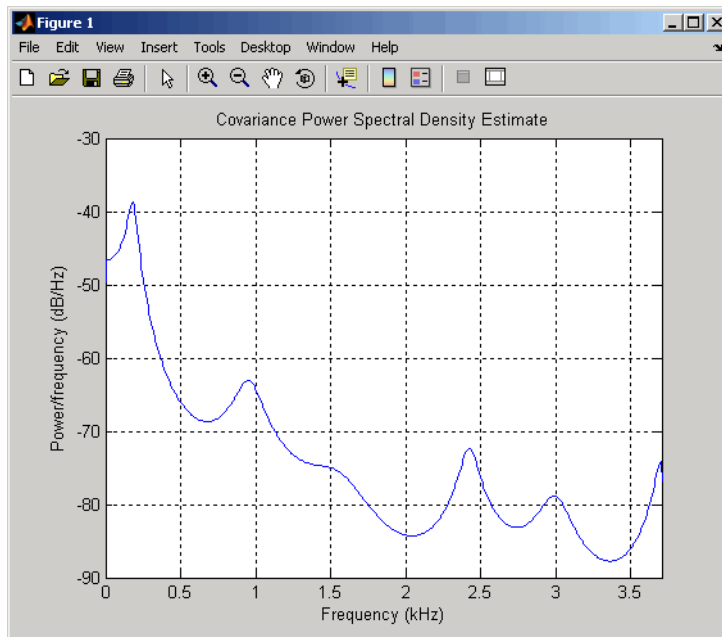

```
Hmcov = spectrum.mcov(14);           % 14th order model
psd(Hmcov,mtlb(1:64),'Fs',Fs,'NFFT',1024)
```

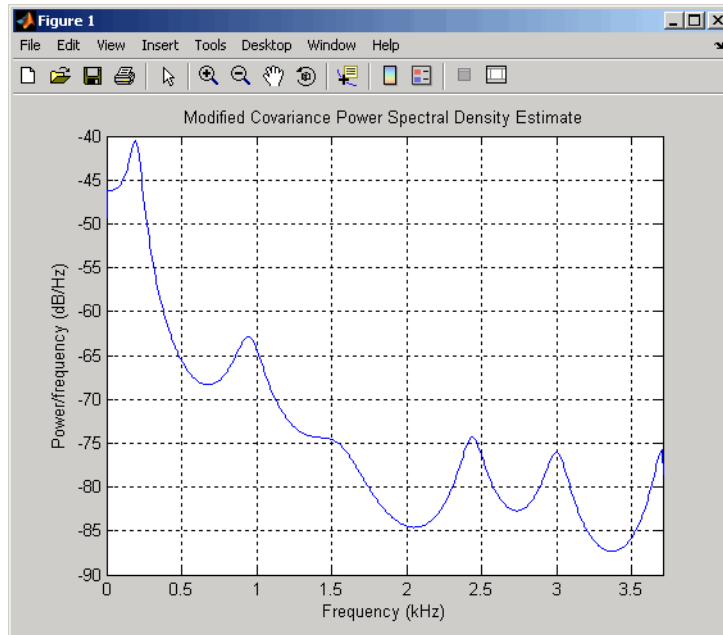

## MUSIC and Eigenvector Analysis Methods

The `spectrum.music` object and `pmusic` function, and `spectrum.eigenvector` object and `peig` function provide two related spectral analysis methods:

- `spectrum.music` and `pmusic` provide the multiple signal classification (MUSIC) method developed by Schmidt
- `spectrum.eigenvector` and `peig` provides the eigenvector (EV) method developed by Johnson

See Marple [3] (pgs. 373-378) for a summary of these methods.

Both of these methods are frequency estimator techniques based on eigenanalysis of the autocorrelation matrix. This type of spectral analysis categorizes the information in a correlation or data matrix, assigning information to either a signal subspace or a noise subspace.

## Eigenanalysis Overview

Consider a number of complex sinusoids embedded in white noise. You can write the autocorrelation matrix  $R$  for this system as the sum of the signal autocorrelation matrix ( $S$ ) and the noise autocorrelation matrix ( $W$ ):

$R = S + W$ . There is a close relationship between the eigenvectors of the signal autocorrelation matrix and the signal and noise subspaces. The eigenvectors  $v$  of  $S$  span the same signal subspace as the signal vectors. If the system contains  $M$  complex sinusoids and the order of the autocorrelation matrix is  $p$ , eigenvectors  $v_{M+1}$  through  $v_{p+1}$  span the noise subspace of the autocorrelation matrix.

**Frequency Estimator Functions.** To generate their frequency estimates, eigenanalysis methods calculate functions of the vectors in the signal and noise subspaces. Both the MUSIC and EV techniques choose a function that goes to infinity (denominator goes to zero) at one of the sinusoidal frequencies in the input signal. Using digital technology, the resulting estimate has sharp peaks at the frequencies of interest; this means that there might not be infinity values in the vectors.

The MUSIC estimate is given by the formula

$$\hat{P}_{\text{MUSIC}}(f) = \frac{1}{\sum_{k=p+1}^M |e(f)^H v_k|^2}$$

where the  $v_k$  are the eigenvectors of the noise subspace and  $e(f)$  is a vector of complex sinusoids.

$$e(f) = [1 \quad e^{j2\pi f} \quad e^{j4\pi f} \quad \dots \quad e^{j2(M-1)\pi f}]^T$$

$v$  represents the eigenvectors of the input signal's correlation matrix;  $v_k$  is the  $k^{\text{th}}$  eigenvector.  $H$  is the conjugate transpose operator. The eigenvectors used in the sum correspond to the smallest eigenvalues and span the noise subspace ( $p$  is the size of the signal subspace).

The expression  $e(f)^H v_k$  is equivalent to a Fourier transform (the vector  $e(f)$  consists of complex exponentials). This form is useful for numeric



computation because the FFT can be computed for each  $v_k$  and then the squared magnitudes can be summed.

The EV method weights the summation by the eigenvalues of the correlation matrix:

$$\hat{P}_{\text{EV}}(f) = \frac{\lambda_k}{\sum_{k=p+1}^M |e^H(f)v_k|^2}$$

The `pmusic` and `peig` functions in this toolbox interpret their first input either as a signal matrix or as a correlation matrix (if the 'corr' input flag is set). In the former case, the singular value decomposition of the signal matrix is used to determine the signal and noise subspaces. In the latter case, the eigenvalue decomposition of the correlation matrix is used to determine the signal and noise subspaces.

## Selected Bibliography

- [1] Hayes, M.H. *Statistical Digital Signal Processing and Modeling*. New York: John Wiley & Sons, 1996.
  
- [2] Kay, S.M. *Modern Spectral Estimation*. Englewood Cliffs, NJ: Prentice Hall, 1988.
  
- [3] Marple, S.L. *Digital Spectral Analysis*. Englewood Cliffs, NJ: Prentice Hall, 1987.
  
- [4] Orfanidis, S.J. *Introduction to Signal Processing*. Upper Saddle River, NJ: Prentice Hall, 1996.
  
- [5] Percival, D.B., and A.T. Walden. *Spectral Analysis for Physical Applications: Multitaper and Conventional Univariate Techniques*. Cambridge: Cambridge University Press, 1993.
  
- [6] Proakis, J.G., and D.G. Manolakis. *Digital Signal Processing: Principles, Algorithms, and Applications*. Englewood Cliffs, NJ: Prentice Hall, 1996.
  
- [7] Stoica, P., and R. Moses. *Introduction to Spectral Analysis*. Upper Saddle River, NJ: Prentice Hall, 1997.
  
- [8] Welch, P.D. "The Use of Fast Fourier Transform for the Estimation of Power Spectra: A Method Based on Time Averaging Over Short, Modified Periodograms." *IEEE Trans. Audio Electroacoust.* Vol. AU-15 (June 1967). Pgs. 70-73.

# Special Topics

---

- “Windows” on page 7-2
- “Parametric Modeling” on page 7-13
- “Resampling” on page 7-21
- “Cepstrum Analysis” on page 7-24
- “FFT-Based Time-Frequency Analysis” on page 7-28
- “Median Filtering” on page 7-29
- “Communications Applications” on page 7-30
- “Deconvolution” on page 7-35
- “Specialized Transforms” on page 7-36
- “Selected Bibliography” on page 7-47

## Windows

In this section...
“Why Use Windows?” on page 7-2
“Available Window Functions” on page 7-2
“Graphical User Interface Tools” on page 7-3
“Basic Shapes” on page 7-3
“Generalized Cosine Windows” on page 7-6
“Kaiser Window” on page 7-8
“Chebyshev Window” on page 7-12

### Why Use Windows?

In both digital filter design and spectral estimation, the choice of a windowing function can play an important role in determining the quality of overall results. The main role of the window is to damp out the effects of the Gibbs phenomenon that results from truncation of an infinite series.

### Available Window Functions

Window	Function
Bartlett-Hann window	barthannwin
Bartlett window	bartlett
Blackman window	blackman
Blackman-Harris window	blackmanharris
Bohman window	bohmanwin
Chebyshev window	chebwin
Flat Top window	flattopwin
Gaussian window	gausswin
Hamming window	hamming

Window	Function
Hann window	<code>hann</code>
Kaiser window	<code>kaiser</code>
Nuttall's Blackman-Harris window	<code>nuttallwin</code>
Parzen (de la Valle-Poussin) window	<code>parzenwin</code>
Rectangular window	<code>rectwin</code>
Tapered cosine window	<code>tukeywin</code>
Triangular window	<code>triang</code>

## Graphical User Interface Tools

Two graphical user interface tools are provided for working with windows in the Signal Processing Toolbox product:

- Window Design and Analysis Tool (`wintool`)
- Window Visualization Tool (`wvtool`)

Refer to the reference pages for these tools for detailed information.

## Basic Shapes

The basic window is the *rectangular window*, a vector of ones of the appropriate length. A rectangular window of length 50 is

```
n = 50;
w = rectwin(n);
```

This toolbox stores windows in column vectors by convention, so an equivalent expression is

```
w = ones(50,1);
```

To use the Window Design and Analysis Tool to create this window, type

```
wintool
```

wintool opens with a default Hamming window. In the Current Window Information panel, set **Type = Rectangular** and **Length = 50** and then press **Apply**.

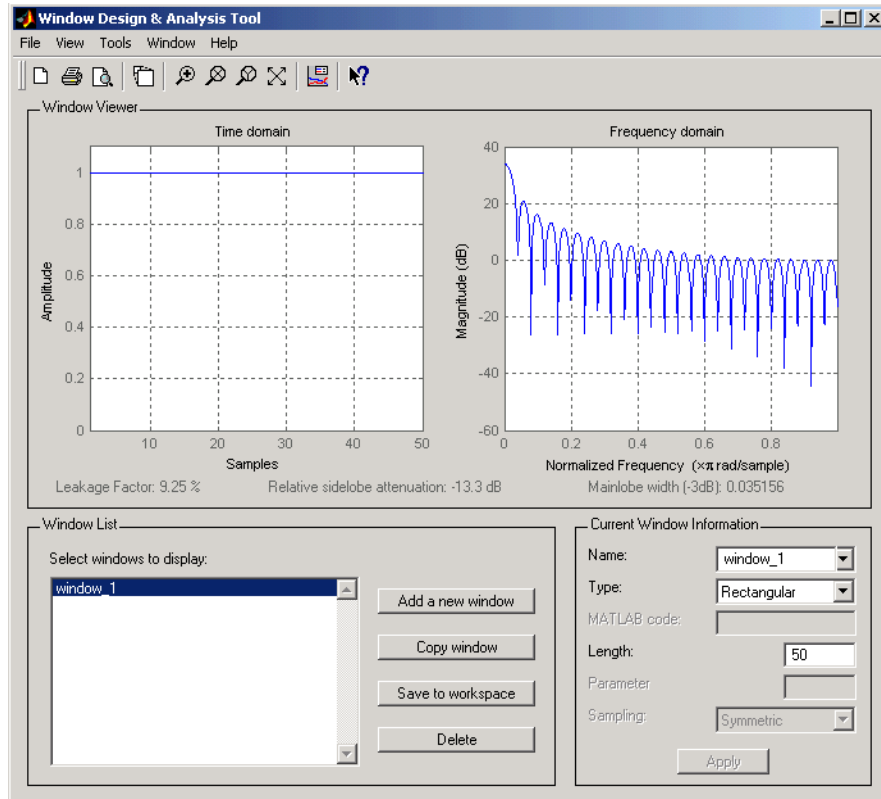

The *Bartlett* (or triangular) *window* is the convolution of two rectangular windows. The functions `bartlett` and `triang` compute similar triangular windows, with three important differences. The `bartlett` function always returns a window with two zeros on the ends of the sequence, so that for  $n$  odd, the center section of `bartlett(n+2)` is equivalent to `triang(n)`:

```
Bartlett = bartlett(7);
isequal(Bartlett(2:end-1),triang(5))
% Returns a 1
```

For  $n$  even, `bartlett` is still the convolution of two rectangular sequences. There is no standard definition for the triangular window for  $n$  even; the slopes of the line segments of the `triang` result are slightly steeper than those of `bartlett` in this case:

```
w = bartlett(8);
[w(2:7) triang(6)]
```

You can see the difference between odd and even Bartlett windows in WinTool.

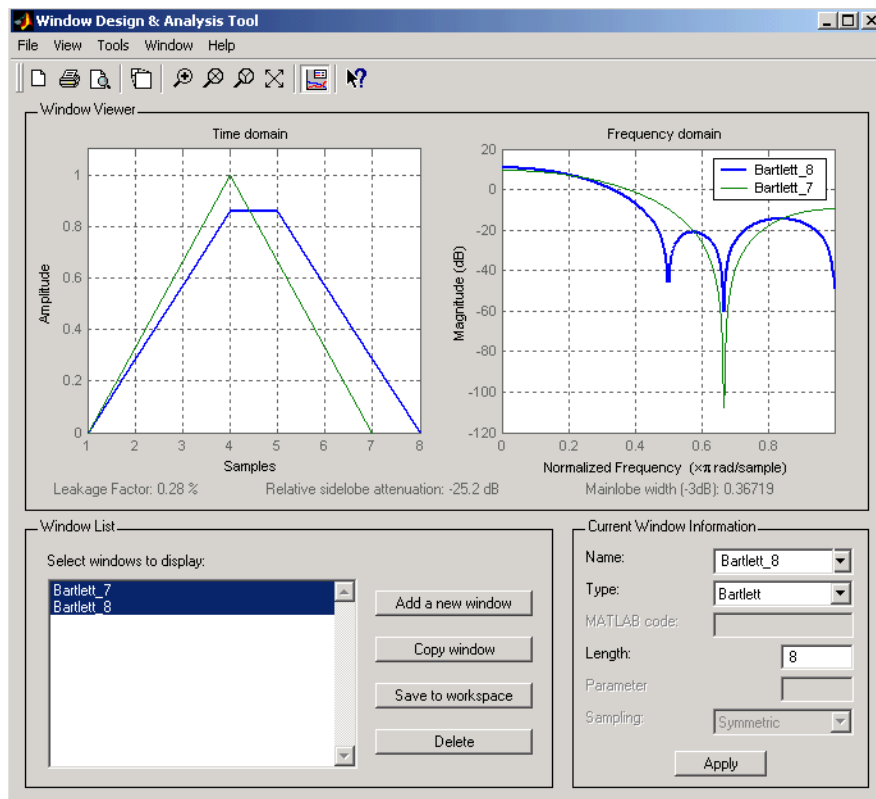

The final difference between the Bartlett and triangular windows is evident in the Fourier transforms of these functions. The Fourier transform of a Bartlett window is negative for  $n$  even. The Fourier transform of a triangular window, however, is always nonnegative.

The following figure, which is a zoomed version of the Frequency domain plot of 8-point Bartlett and Triangular windows with the  $y$ -axis set to Zero-Phase, illustrates this difference.

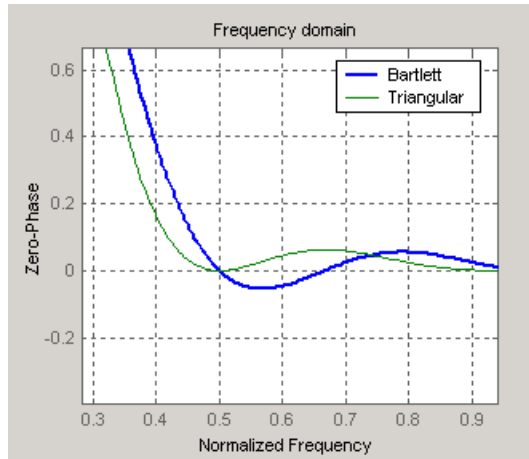

This difference can be important when choosing a window for some spectral estimation techniques, such as the Blackman-Tukey method. Blackman-Tukey forms the spectral estimate by calculating the Fourier transform of the autocorrelation sequence. The resulting estimate might be negative at some frequencies if the window's Fourier transform is negative (see Kay [1], pg. 80).

## Generalized Cosine Windows

Blackman, flat top, Hamming, Hann, and rectangular windows are all special cases of the *generalized cosine window*. These windows are combinations of sinusoidal sequences with frequencies that are multiples of  $2\pi/(N-1)$ , where  $N$  is the window length. One special case is the Blackman window:

```
N = 128;
A = 0.42; B = 0.5; C = 0.08;
ind = (0:N-1)'*2*pi/(N-1);
w = A - B*cos(ind) + C*cos(2*ind);
```

Changing the values of the constants  $A$ ,  $B$ , and  $C$  in the previous expression generates different generalized cosine windows like the Hamming and Hann



windows. Adding additional cosine terms of higher frequency generates the flat top window. The concept behind these windows is that by summing the individual terms to form the window, the low frequency peaks in the frequency domain combine in such a way as to decrease sidelobe height. This has the side effect of increasing the mainlobe width.

The Hamming and Hann windows are two-term generalized cosine windows, given by  $A = 0.54$ ,  $B = 0.46$  for the Hamming and  $A = 0.5$ ,  $B = 0.5$  for the Hann.

Note that the definition of the generalized cosine window shown in the earlier MATLAB code yields zeros at samples 1 and  $n$  for  $A = 0.5$  and  $B = 0.5$ .

This WinTool compares Blackman, Hamming, Hann, and Flat Top windows.

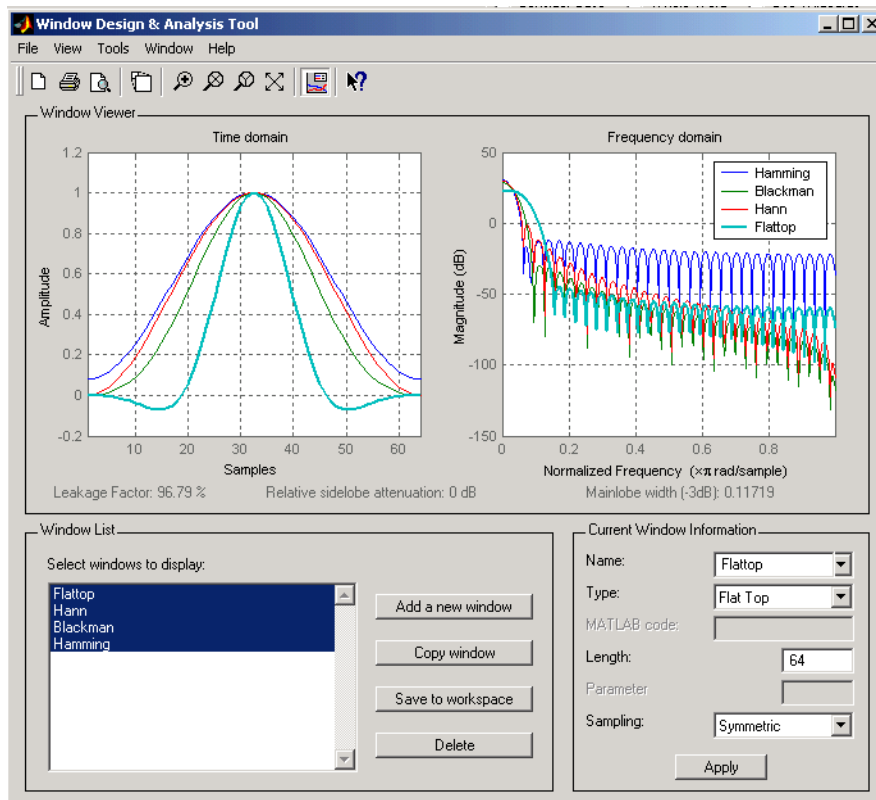

## Kaiser Window

The *Kaiser window* is an approximation to the prolate-spheroidal window, for which the ratio of the mainlobe energy to the sidelobe energy is maximized. For a Kaiser window of a particular length, the parameter  $\beta$  controls the sidelobe height. For a given  $\beta$ , the sidelobe height is fixed with respect to window length. The statement `kaiser(n,beta)` computes a length  $n$  Kaiser window with parameter  $\beta$ .

Examples of Kaiser windows with length 50 and beta parameters of 1, 4, and 9 are shown in this wintool example.

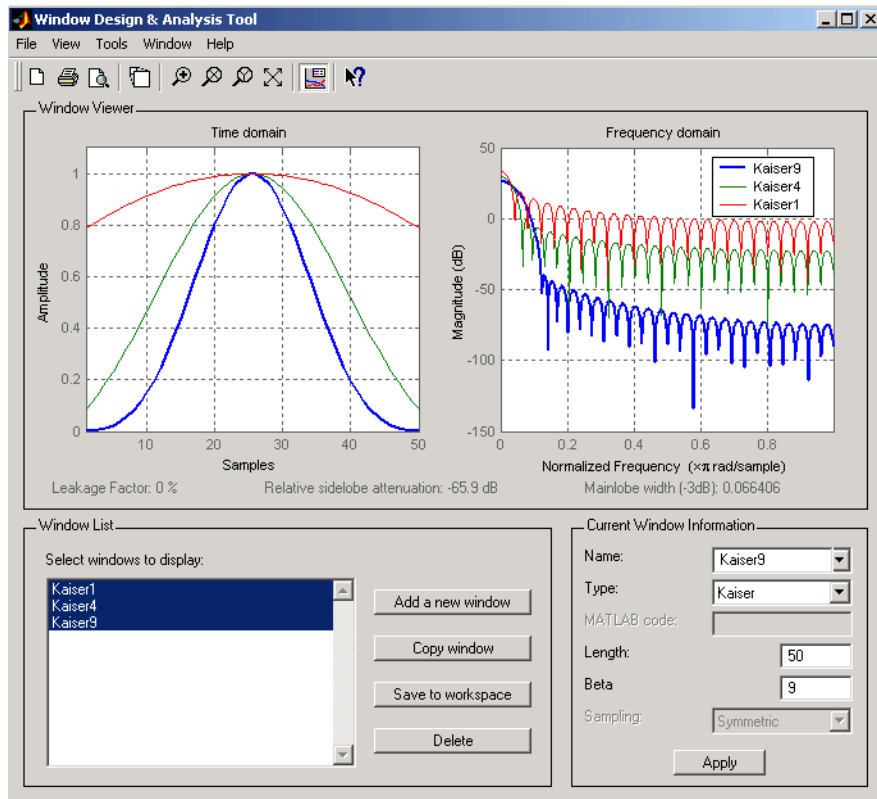

To create these Kaiser windows using the MATLAB command line,

```
n = 50;
```

```

w1 = kaiser(n,1);
w2 = kaiser(n,4);
w3 = kaiser(n,9);
[W1,f] = freqz(w1/sum(w1),1,512,2);
[W2,f] = freqz(w2/sum(w2),1,512,2);
[W3,f] = freqz(w3/sum(w3),1,512,2);
plot(f,20*log10(abs([W1 W2 W3]))); grid;
legend('beta = 1','beta = 4','beta = 9',3)

```

As  $\beta$  increases, the sidelobe height decreases and the mainlobe width increases. This wintool shows how the sidelobe height stays the same for a fixed  $\beta$  parameter as the length is varied.

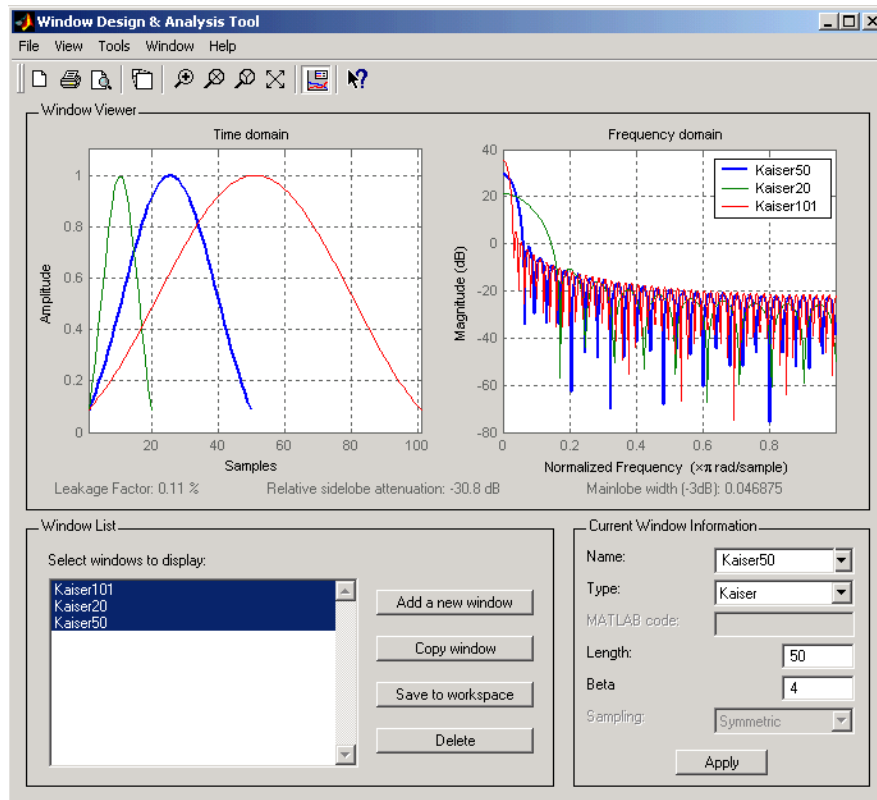

To create these Kaiser windows using the MATLAB command line:

```

w1 = kaiser(50,4);
w2 = kaiser(20,4);
w3 = kaiser(101,4);
[W1,f] = freqz(w1/sum(w1),1,512,2);
[W2,f] = freqz(w2/sum(w2),1,512,2);
[W3,f] = freqz(w3/sum(w3),1,512,2);
plot(f,20*log10(abs([W1 W2 W3]))); grid;
legend('length = 50','length = 20','length = 101')

```

### Kaiser Windows in FIR Design

There are two design formulas that can help you design FIR filters to meet a set of filter specifications using a Kaiser window. To achieve a sidelobe height of  $-\alpha$  dB, the beta parameter is

$$\beta = \begin{cases} 0.1102(\alpha - 8.7), & \alpha > 50 \\ 0.5842(\alpha - 21)^{0.4} + 0.07886(\alpha - 21), & 50 \geq \alpha \geq 21 \\ 0, & \alpha < 21 \end{cases}$$

For a transition width of  $\Delta\omega$  rad/s, use the length

$$n = \frac{\alpha - 8}{2.285\Delta\omega} + 1$$

Filters designed using these heuristics will meet the specifications approximately, but you should verify this. To design a lowpass filter with cutoff frequency  $0.5\pi$  rad/s, transition width  $0.2\pi$  rad/s, and 40 dB of attenuation in the stopband, try

```

[n,wn,beta] = kaiserord([0.4 0.6]*pi,[1 0],[0.01 0.01],2*pi);
h = fir1(n,wn,kaiser(n+1,beta),'noscale');

```

The `kaiserord` function estimates the filter order, cutoff frequency, and Kaiser window beta parameter needed to meet a given set of frequency domain specifications.

The ripple in the passband is roughly the same as the ripple in the stopband. As you can see from the frequency response, this filter nearly meets the specifications:

```
fvtool(h,1);
```

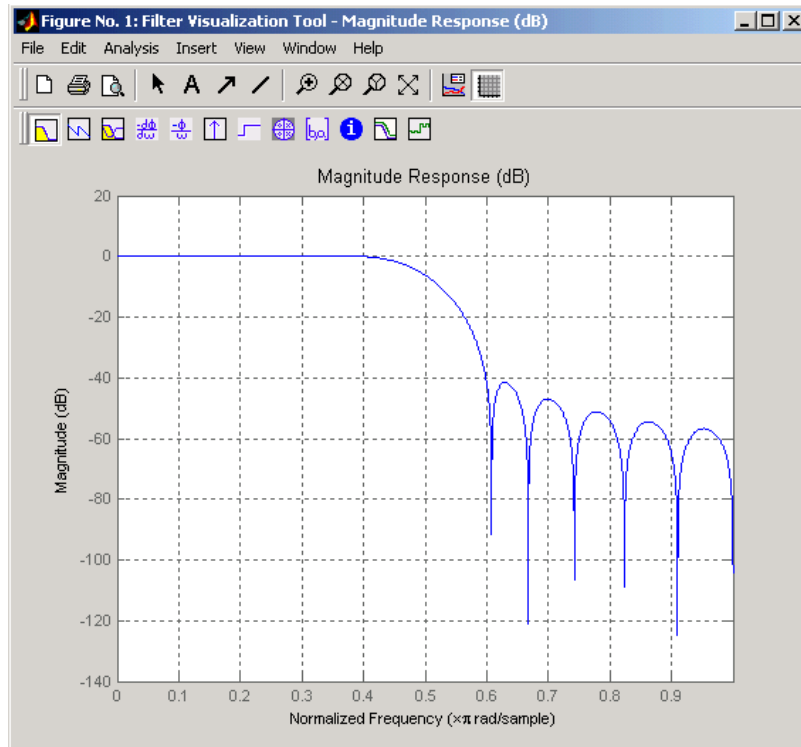

## Chebyshev Window

The Chebyshev window minimizes the mainlobe width, given a particular sidelobe height. It is characterized by an equiripple behavior, that is, its sidelobes all have the same height.

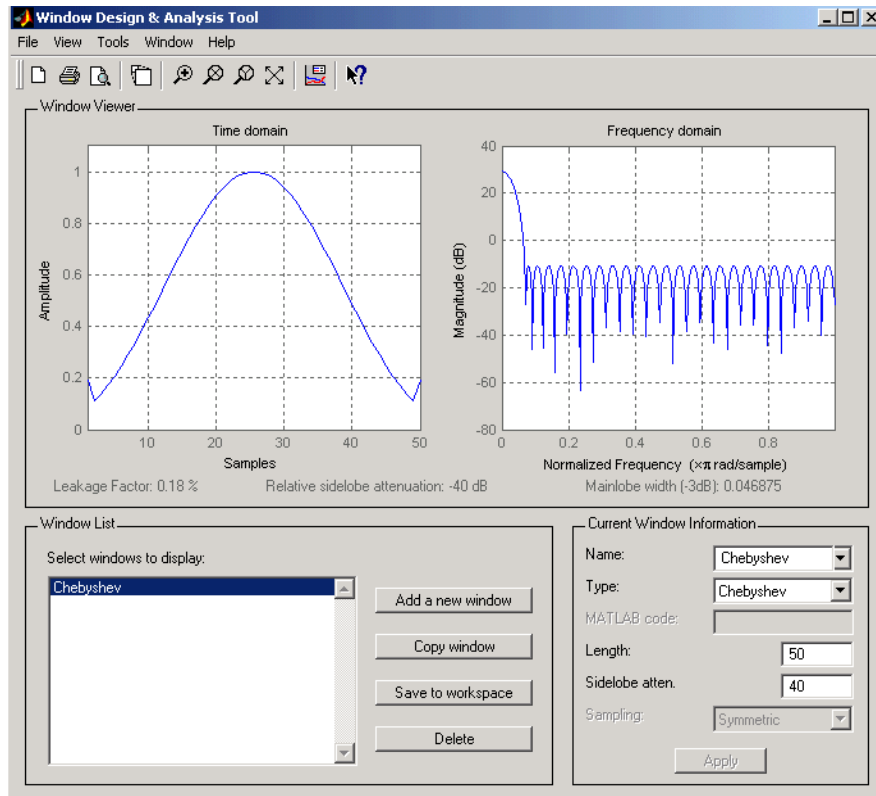

As shown in the Time Domain plot, the Chebyshev window has large spikes at its outer samples.

For a detailed discussion of the characteristics and applications of the various window types, see Oppenheim and Schaffer [3], pgs. 444-462, and Parks and Burrus [4], pgs. 71-73.

# Parametric Modeling

**In this section...**

“What is Parametric Modeling” on page 7-13

“Available Parametric Modeling Functions” on page 7-13

“Time-Domain Based Modeling” on page 7-14

“Frequency-Domain Based Modeling” on page 7-18

## What is Parametric Modeling

Parametric modeling techniques find the parameters for a mathematical model describing a signal, system, or process. These techniques use known information about the system to determine the model. Applications for parametric modeling include speech and music synthesis, data compression, high-resolution spectral estimation, communications, manufacturing, and simulation.

## Available Parametric Modeling Functions

The toolbox parametric modeling functions operate with the rational transfer function model. Given appropriate information about an unknown system (impulse or frequency response data, or input and output sequences), these functions find the coefficients of a linear system that models the system.

One important application of the parametric modeling functions is in the design of filters that have a prescribed time or frequency response.

Here is a summary of the parametric modeling functions in this toolbox.

Domain	Functions	Description
Time	arburg	Generate all-pole filter coefficients that model an input data sequence using the Levinson-Durbin algorithm.
	arcov	Generate all-pole filter coefficients that model an input data sequence by minimizing the forward prediction error.
	armcov	Generate all-pole filter coefficients that model an input data sequence by minimizing the forward and backward prediction errors.
	aryule	Generate all-pole filter coefficients that model an input data sequence using an estimate of the autocorrelation function.
	lpc, levinson	Linear Predictive Coding. Generate all-pole recursive filter whose impulse response matches a given sequence.
	prony	Generate IIR filter whose impulse response matches a given sequence.
	stmcb	Find IIR filter whose output, given a specified input sequence, matches a given output sequence.
Frequency	invfreqz, invfreqs	Generate digital or analog filter coefficients given complex frequency response data.

## Time-Domain Based Modeling

The `lpc`, `prony`, and `stmcb` functions find the coefficients of a digital rational transfer function that approximates a given time-domain impulse response. The algorithms differ in complexity and accuracy of the resulting model.

### Linear Prediction

Linear prediction modeling assumes that each output sample of a signal,  $x(k)$ , is a linear combination of the past  $n$  outputs (that is, it can be linearly



predicted from these outputs), and that the coefficients are constant from sample to sample:

$$x(k) = -a(2)x(k-1) - a(3)x(k-2) - \dots - a(n+1)x(k-n)$$

An  $n$ th-order all-pole model of a signal  $x$  is

```
a = lpc(x,n)
```

To illustrate `lpc`, create a sample signal that is the impulse response of an all-pole filter with additive white noise:

```
x = impz(1,[1 0.1 0.1 0.1 0.1],10) + randn(10,1)/10;
```

The coefficients for a fourth-order all-pole filter that models the system are

```
a = lpc(x,4)
```

`lpc` first calls `xcorr` to find a biased estimate of the correlation function of  $x$ , and then uses the Levinson-Durbin recursion, implemented in the `levinson` function, to find the model coefficients  $a$ . The Levinson-Durbin recursion is a fast algorithm for solving a system of symmetric Toeplitz linear equations. `lpc`'s entire algorithm for  $n = 4$  is

```
r = xcorr(x);
r(1:length(x)-1) = [];      % Remove corr. at negative lags
a = levinson(r,4)
```

You could form the linear prediction coefficients with other assumptions by passing a different correlation estimate to `levinson`, such as the biased correlation estimate:

```
r = xcorr(x,'biased');
r(1:length(x)-1) = [];      % Remove corr. at negative lags
a = levinson(r,4)
```

### **Prony's Method (ARMA Modeling)**

The prony function models a signal using a specified number of poles and zeros. Given a sequence  $x$  and numerator and denominator orders  $n$  and  $m$ , respectively, the statement

```
[b,a] = prony(x,n,m)
```

finds the numerator and denominator coefficients of an IIR filter whose impulse response approximates the sequence  $x$ .

The prony function implements the method described in [4] Parks and Burrus (pgs. 226-228). This method uses a variation of the covariance method of AR modeling to find the denominator coefficients  $a$ , and then finds the numerator coefficients  $b$  for which the resulting filter's impulse response matches exactly the first  $n + 1$  samples of  $x$ . The filter is not necessarily stable, but it can potentially recover the coefficients exactly if the data sequence is truly an autoregressive moving-average (ARMA) process of the correct order.

---

**Note** The functions `prony` and `stmcb` (described next) are more accurately described as ARX models in system identification terminology. ARMA modeling assumes noise only at the inputs, while ARX assumes an external input. `prony` and `stmcb` know the input signal: it is an impulse for `prony` and is arbitrary for `stmcb`.

---

A model for the test sequence  $x$  (from the earlier `lpc` example) using a third-order IIR filter is

```
[b,a] = prony(x,3,3)
```

The `impz` command shows how well this filter's impulse response matches the original sequence:

```
format long  
[x impz(b,a,10)]
```

Notice that the first four samples match exactly. For an example of exact recovery, recover the coefficients of a Butterworth filter from its impulse response:

```
[b,a] = butter(4,.2);
h = impz(b,a,26);
[bb,aa] = prony(h,4,4);
```

Try this example; you'll see that `bb` and `aa` match the original filter coefficients to within a tolerance of  $10^{-13}$ .

### Steiglitz-McBride Method (ARMA Modeling)

The `stmcb` function determines the coefficients for the system  $b(z)/a(z)$  given an approximate impulse response `x`, as well as the desired number of zeros and poles. This function identifies an unknown system based on both input and output sequences that describe the system's behavior, or just the impulse response of the system. In its default mode, `stmcb` works like `prony`.

```
[b,a] = stmcb(x,3,3)
```

`stmcb` also finds systems that match given input and output sequences:

```
y = filter(1,[1 1],x);    % Create an output signal.
[b,a] = stmcb(y,x,0,1)
```

In this example, `stmcb` correctly identifies the system used to create `y` from `x`.

The Steiglitz-McBride method is a fast iterative algorithm that solves for the numerator and denominator coefficients simultaneously in an attempt to minimize the signal error between the filter output and the given output signal. This algorithm usually converges rapidly, but might not converge if the model order is too large. As for `prony`, `stmcb`'s resulting filter is not necessarily stable due to its exact modeling approach.

`stmcb` provides control over several important algorithmic parameters; modify these parameters if you are having trouble modeling the data. To change the number of iterations from the default of five and provide an initial estimate for the denominator coefficients:

```
n = 10;                % Number of iterations
a = lpc(x,3);         % Initial estimates for denominator
[b,a] = stmcb(x,3,3,n,a);
```

The function uses an all-pole model created with `prony` as an initial estimate when you do not provide one of your own.

To compare the functions `lpc`, `prony`, and `stmcb`, compute the signal error in each case:

```
a1 = lpc(x,3);  
[b2,a2] = prony(x,3,3);  
[b3,a3] = stmcb(x,3,3);  
[x-impz(1,a1,10) x-impz(b2,a2,10) x-impz(b3,a3,10)]
```

In comparing modeling capabilities for a given order IIR model, the last result shows that for this example, `stmcb` performs best, followed by `prony`, then `lpc`. This relative performance is typical of the modeling functions.

## Frequency-Domain Based Modeling

The `invfreqs` and `invfreqz` functions implement the inverse operations of `freqs` and `freqz`; they find an analog or digital transfer function of a specified order that matches a given complex frequency response. Though the following examples demonstrate `invfreqz`, the discussion also applies to `invfreqs`.

To recover the original filter coefficients from the frequency response of a simple digital filter:

```
[b,a] = butter(4,0.4)           % Design Butterworth lowpass  
  
[h,w] = freqz(b,a,64);         % Compute frequency response  
[b4,a4] = invfreqz(h,w,4,4)    % Model: n = 4, m = 4
```

The vector of frequencies `w` has the units in rad/sample, and the frequencies need not be equally spaced. `invfreqz` finds a filter of any order to fit the frequency data; a third-order example is

```
[b4,a4] = invfreqz(h,w,3,3)    % Find third-order IIR
```

Both `invfreqs` and `invfreqz` design filters with real coefficients; for a data point at positive frequency `f`, the functions fit the frequency response at both `f` and `-f`.

By default `invfreqz` uses an equation error method to identify the best model from the data. This finds  $b$  and  $a$  in

$$\min_{b, a} \sum_{k=1}^n wt(k) |h(k)A(\omega(k)) - B(\omega(k))|^2$$

by creating a system of linear equations and solving them with the MATLAB `\` operator. Here  $A(\omega(k))$  and  $B(\omega(k))$  are the Fourier transforms of the polynomials  $a$  and  $b$  respectively at the frequency  $\omega(k)$ , and  $n$  is the number of frequency points (the length of  $h$  and  $w$ ).  $wt(k)$  weights the error relative to the error at different frequencies. The syntax

```
invfreqz(h,w,n,m,wt)
```

includes a weighting vector. In this mode, the filter resulting from `invfreqz` is not guaranteed to be stable.

`invfreqz` provides a superior (“output-error”) algorithm that solves the direct problem of minimizing the weighted sum of the squared error between the actual frequency response points and the desired response

$$\min_{b, a} \sum_{k=1}^n wt(k) \left| h(k) - \frac{B(\omega(k))}{A(\omega(k))} \right|^2$$

To use this algorithm, specify a parameter for the iteration count after the weight vector parameter:

```
wt = ones(size(w)); % Create unity weighting vector
[b30,a30] = invfreqz(h,w,3,3,wt,30) % 30 iterations
```

The resulting filter is always stable.

Graphically compare the results of the first and second algorithms to the original Butterworth filter with FVTool (and select the Magnitude and Phase Responses):

```
fvtool(b, a, b4, a4, b30, a30)
```

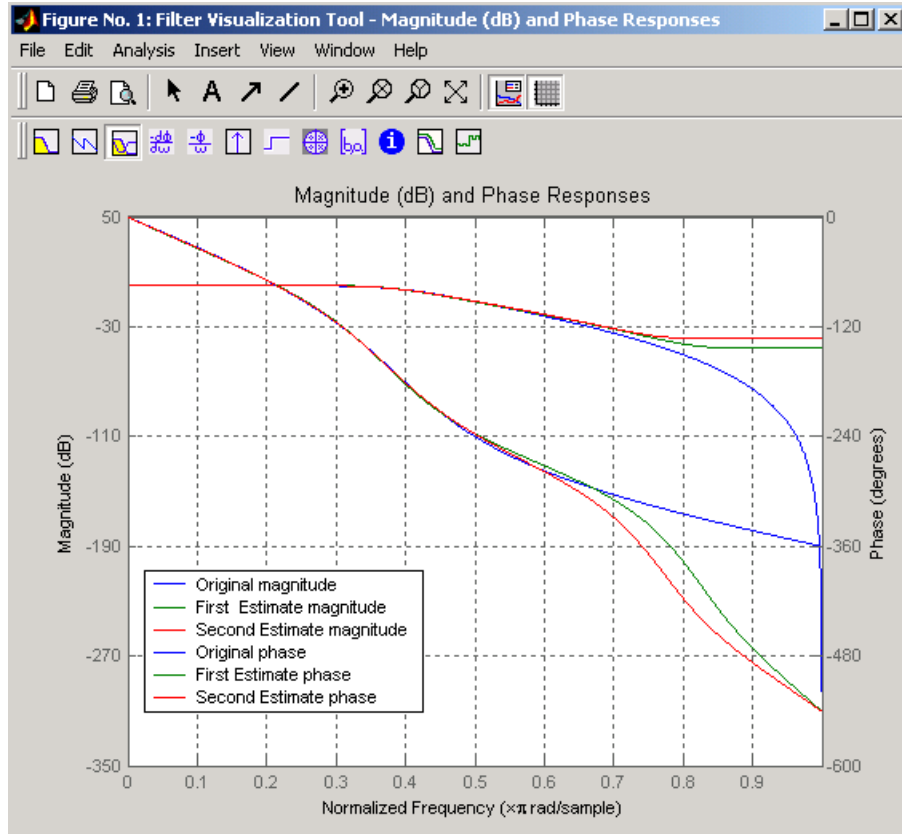

To verify the superiority of the fit numerically, type

```
sum(abs(h-freqz(b4,a4,w)).^2) % Total error, algorithm 1
sum(abs(h-freqz(b30,a30,w)).^2) % Total error, algorithm 2
```

## Resampling

In this section...
“Available Resampling Functions” on page 7-21
“resample Function” on page 7-21
“decimate and interp Functions” on page 7-23
“upfirdn Function” on page 7-23
“spline Function” on page 7-23

### Available Resampling Functions

The toolbox provides a number of functions that resample a signal at a higher or lower rate.

Operation	Function
Apply FIR filter with resampling	upfirdn
Cubic spline interpolation	spline
Decimation	decimate
Interpolation	interp
Other 1-D interpolation	interp1
Resample at new rate	resample

### resample Function

The `resample` function changes the sampling rate for a sequence to any rate that is a ratio of two integers. The basic syntax for `resample` is

```
y = resample(x,p,q)
```

where the function resamples the sequence `x` at  $p/q$  times the original sampling rate. The length of the result `y` is  $p/q$  times the length of `x`.

One resampling application is the conversion of digitized audio signals from one sampling rate to another, such as from 48 kHz (the digital audio tape standard) to 44.1 kHz (the compact disc standard).

The example file contains a length 4001 vector of speech sampled at 7418 Hz:

```
clear
load mtlb
whos
```

Name	Size	Bytes	Class
Fs	1x1	8	double array
mtlb	4001x1	32008	double array

```
Grand total is 4002 elements using 32016 bytes
```

```
Fs
Fs =
    7418
```

To play this speech signal on a workstation that can only play sound at 8192 Hz, use the `rat` function to find integers  $p$  and  $q$  that yield the correct resampling factor:

```
[p,q] = rat(8192/Fs,0.0001)
p =
    127
q =
    115
```

Since  $p/q*Fs = 8192.05$  Hz, the tolerance of 0.0001 is acceptable; to resample the signal at very close to 8192 Hz:

```
y = resample(mtlb,p,q);
```

`resample` applies a lowpass filter to the input sequence to prevent aliasing during resampling. It designs this filter using the `firls` function with a Kaiser window. The syntax

```
resample(x,p,q,l,beta)
```



controls the filter's length and the beta parameter of the Kaiser window. Alternatively, use the function `intfilt` to design an interpolation filter `b` and use it with

```
resample(x,p,q,b)
```

## **decimate and interp Functions**

The `decimate` and `interp` functions do the same thing as `resample` with  $p = 1$  and  $q = 1$ , respectively. These functions provide different anti-alias filtering options, and they incur a slight signal delay due to filtering. The `interp` function is significantly less efficient than the `resample` function with  $q = 1$ .

## **upfirdn Function**

The toolbox also contains a function, `upfirdn`, that applies an FIR filter to an input sequence and outputs the filtered sequence at a sample rate different than its original. See “Multirate Filter Bank Implementation” on page 1-8.

## **spline Function**

The standard MATLAB environment contains a function, `spline`, that works with irregularly spaced data. The MATLAB function `interp1` performs interpolation, or table lookup, using various methods including linear and cubic interpolation.

## Cepstrum Analysis

### In this section...

“What Is a Cepstrum?” on page 7-24

“Inverse Complex Cepstrum” on page 7-27

### What Is a Cepstrum?

Cepstrum analysis is a nonlinear signal processing technique with a variety of applications in areas such as speech and image processing.

The complex cepstrum for a sequence  $x$  is calculated by finding the complex natural logarithm of the Fourier transform of  $x$ , then the inverse Fourier transform of the resulting sequence.

$$\hat{x} = \frac{1}{2\pi} \int_{-\pi}^{\pi} \log[X(e^{j\omega})] e^{j\omega n} d\omega$$

The toolbox function `cceps` performs this operation, estimating the complex cepstrum for an input sequence. It returns a real sequence the same size as the input sequence:

```
xhat = cceps(x)
```

For sequences that have roots on the unit circle, cepstrum analysis has numerical problems. See Oppenheim and Schaffer [2] for information.

The complex cepstrum transformation is central to the theory and application of *homomorphic systems*, that is, systems that obey certain general rules of superposition. See Oppenheim and Schaffer [3] for a discussion of the complex cepstrum and homomorphic transformations, with details on speech processing applications.

Try using `cceps` in an echo detection application. First, create a 45 Hz sine wave sampled at 100 Hz:

```
t = 0:0.01:1.27;
s1 = sin(2*pi*45*t);
```

Add an echo of the signal, with half the amplitude, 0.2 seconds after the beginning of the signal.

```
s2 = s1 + 0.5*[zeros(1,20) s1(1:108)];
```

The complex cepstrum of this new signal is

```
c = cceps(s2);
plot(t,c)
```

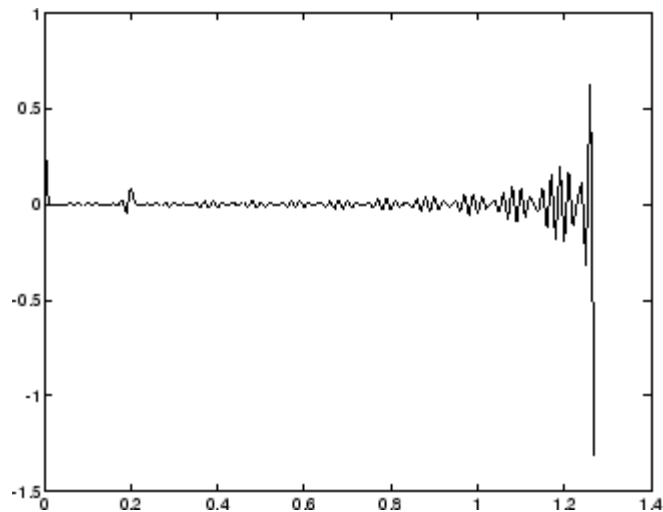

Note that the complex cepstrum shows a peak at 0.2 seconds, indicating the echo.

The *real cepstrum* of a signal  $x$ , sometimes called simply the cepstrum, is calculated by determining the natural logarithm of magnitude of the Fourier transform of  $x$ , then obtaining the inverse Fourier transform of the resulting sequence.

$$c_x = \frac{1}{2\pi} \int_{-\pi}^{\pi} \log |X(e^{j\omega})| e^{j\omega n} d\omega$$

The toolbox function `rceps` performs this operation, returning the real cepstrum for a sequence `x`. The returned sequence is a real-valued vector the same size as the input vector:

```
y = rceps(x)
```

By definition, you cannot reconstruct the original sequence from its real cepstrum transformation, as the real cepstrum is based only on the magnitude of the Fourier transform for the sequence (see Oppenheim and Schaffer [3]). The `rceps` function also returns a unique minimum-phase sequence that has the same real cepstrum as `x`. To obtain both the real cepstrum and the minimum phase reconstruction for a sequence, use

```
[y,ym] = rceps(x)
```

where `y` is the real cepstrum and `ym` is the minimum phase reconstruction of `x`. The following example shows that one output of `rceps` is a unique minimum-phase sequence with the same real cepstrum as `x`.

```
y = [4 1 5]; % Non-minimum phase sequence
[xhat,yhat] = rceps(y);
xhat2= rceps(yhat);
[xhat' xhat2']
```

```
ans =
    1.6225    1.6225
    0.3400    0.3400
    0.3400    0.3400
```

### Summary of Cepstrum Functions

The Signal Processing Toolbox product provides three functions for cepstrum analysis:

Operation	Function
Complex cepstrum	<code>cceps</code>
Inverse complex cepstrum	<code>icceps</code>
Real cepstrum	<code>rceps</code>

## Inverse Complex Cepstrum

To invert the complex cepstrum, use the `icceps` function. Inversion is complicated by the fact that the `cceps` function performs a data dependent phase modification so that the unwrapped phase of its input is continuous at zero frequency. The phase modification is equivalent to an integer delay. This delay term is returned by `cceps` if you ask for a second output. For example:

```
x = 1:10;
[xhat,delay] = cceps(x)
xhat =
  Columns 1 through 4
    2.2428   -0.0420   -0.0210    0.0045
  Columns 5 through 8
    0.0366    0.0788    0.1386    0.2327
  Columns 9 through 10
    0.4114    0.9249
delay =
    1
```

To invert the complex cepstrum, use `icceps` with the original delay parameter:

```
icc = icceps(xhat,2)
ans =
  Columns 1 through 4
    2.0000    3.0000    4.0000    5.0000
  Columns 5 through 8
    6.0000    7.0000    8.0000    9.0000
  Columns 9 through 10
    10.0000    1.0000
```

As shown in the above example, with any modification of the complex cepstrum, the original delay term may no longer be valid. You will not be able to invert the complex cepstrum exactly.

## FFT-Based Time-Frequency Analysis

The Signal Processing Toolbox product provides a function, `spectrogram`, that returns the time-dependent Fourier transform for a sequence, or displays this information as a spectrogram. The *time-dependent Fourier transform* is the discrete-time Fourier transform for a sequence, computed using a sliding window. This form of the Fourier transform, also known as the short-time Fourier transform (STFT), has numerous applications in speech, sonar, and radar processing. The *spectrogram* of a sequence is the magnitude of the time-dependent Fourier transform versus time.

To display the spectrogram of a linear FM signal:

```
fs = 10000;  
t = 0:1/fs:2;  
x = vco(sawtooth(2*pi*t, .75), [0.1 0.4]*fs, fs);  
spectrogram(x, kaiser(256, 5), 220, 512, fs, 'yaxis')
```

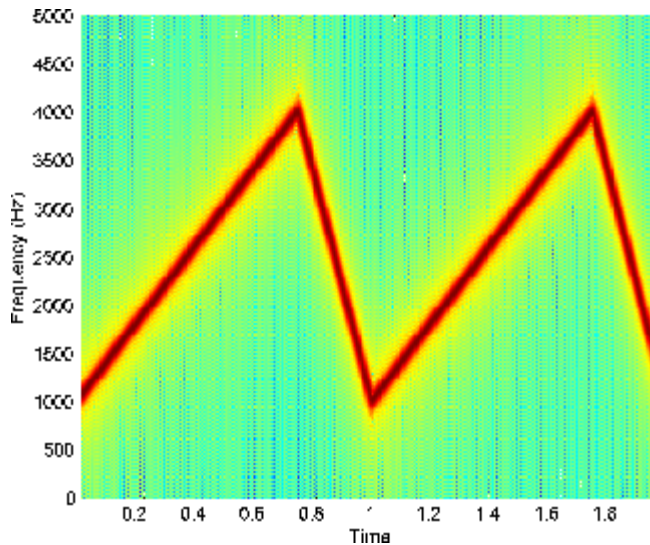

## Median Filtering

The function `medfilt1` implements one-dimensional median filtering, a nonlinear technique that applies a sliding window to a sequence. The median filter replaces the center value in the window with the median value of all the points within the window [5]. In computing this median, `medfilt1` assumes zeros beyond the input points.

When the number of elements  $n$  in the window is even, `medfilt1` sorts the numbers, then takes the average of the  $n/2$  and  $n/2 + 1$  elements.

Two simple examples with fourth- and third-order median filters are

```
medfilt1([4 3 5 2 8 9 1],4)
ans =
    1.500  3.500  3.500  4.000  6.500  5.000  4.500
```

```
medfilt1([4 3 5 2 8 9 1],3)
ans =
     3     4     3     5     8     8     1
```

See the `medfilt2` function in the Image Processing Toolbox™ for information on two-dimensional median filtering.

## Communications Applications

### In this section...

“Modulation” on page 7-30

“Demodulation” on page 7-31

“Voltage Controlled Oscillator” on page 7-34

### Modulation

*Modulation* varies the amplitude, phase, or frequency of a *carrier signal* with reference to a *message signal*. The `modulate` function modulates a message signal with a specified modulation method.

The basic syntax for the `modulate` function is

```
y = modulate(x,fc,fs,'method',opt)
```

where:

- `x` is the message signal.
- `fc` is the carrier frequency.
- `fs` is the sampling frequency.
- `method` is a flag for the desired modulation method.
- `opt` is any additional argument that the method requires. (Not all modulation methods require an option argument.)

The table below summarizes the modulation methods provided; see the documentation for `modulate`, `demod`, and `vco` for complete details on each.

Method	Description
<code>amdsb-sc</code> or <code>am</code>	Amplitude modulation, double sideband, suppressed carrier
<code>amdsb-tc</code>	Amplitude modulation, double sideband, transmitted carrier



Method	Description
amssb	Amplitude modulation, single sideband
fm	Frequency modulation
pm	Phase modulation
ppm	Pulse position modulation
pwm	Pulse width modulation
qam	Quadrature amplitude modulation

If the input  $x$  is an array rather than a vector, `modulate` modulates each column of the array.

To obtain the time vector that `modulate` uses to compute the modulated signal, specify a second output parameter:

```
[y,t] = modulate(x,fc,fs,'method',opt)
```

## Demodulation

The `demod` function performs *demodulation*, that is, it obtains the original message signal from the modulated signal:

The syntax for `demod` is

```
x = demod(y,fc,fs,'method',opt)
```

`demod` uses any of the methods shown for `modulate`, but the syntax for quadrature amplitude demodulation requires two output parameters:

```
[X1,X2] = demod(y,fc,fs,'qam')
```

If the input  $y$  is an array, `demod` demodulates all columns.

Try modulating and demodulating a signal. A 50 Hz sine wave sampled at 1000 Hz is

```
t = (0:1/1000:2);
x = sin(2*pi*50*t);
```

With a carrier frequency of 200 Hz, the modulated and demodulated versions of this signal are

```
y = modulate(x,200,1000,'am');  
z = demod(y,200,1000,'am');
```

To plot portions of the original, modulated, and demodulated signal:

```
figure; plot(t(1:150),x(1:150)); title('Original Signal');  
figure; plot(t(1:150),y(1:150)); title('Modulated Signal');  
figure; plot(t(1:150),z(1:150)); title('Demodulated Signal');
```

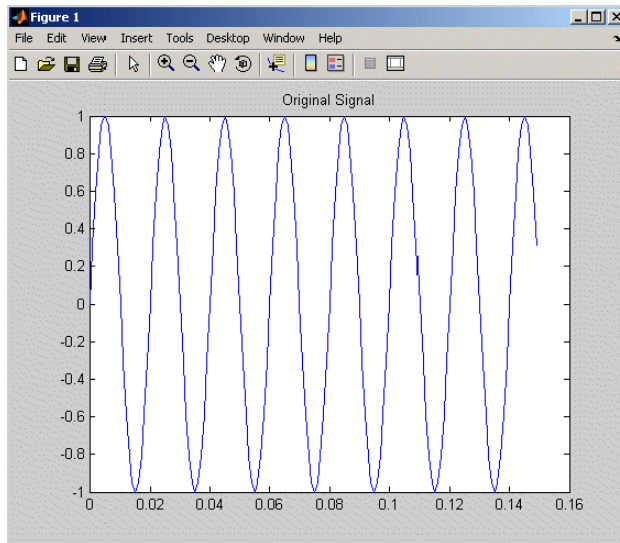

**Original Signal**

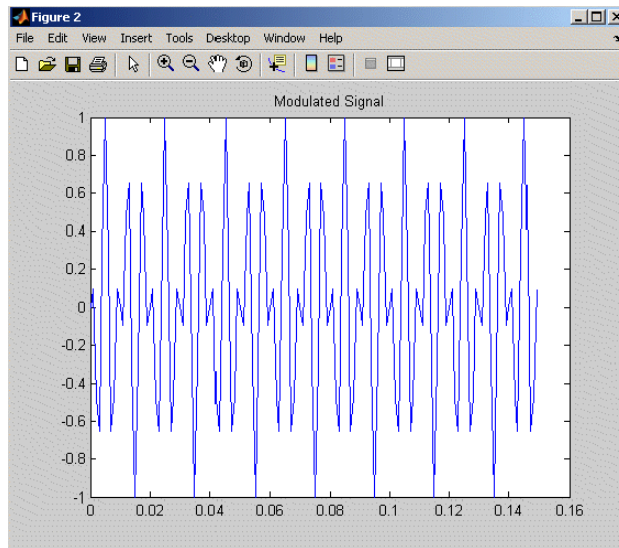

**Modulated Signal**

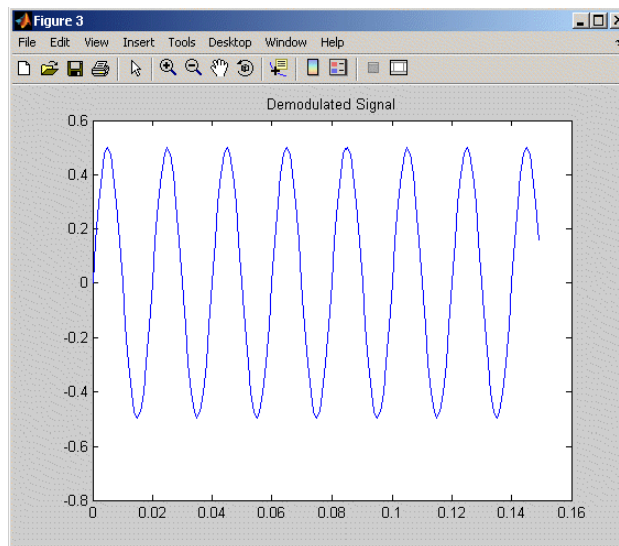

**Demodulated Signal**

---

**Note** The demodulated signal is attenuated because demodulation includes two steps: multiplication and lowpass filtering. The multiplication produces a component with frequency centered at 0 Hz and a component with frequency at twice the carrier frequency. The filtering removes the higher frequency component of the signal, producing the attenuated result.

---

## Voltage Controlled Oscillator

The voltage controlled oscillator function `vco` creates a signal that oscillates at a frequency determined by the input vector. The basic syntax for `vco` is

$$y = \text{vco}(x, fc, fs)$$

where `fc` is the carrier frequency and `fs` is the sampling frequency.

To scale the frequency modulation range, use

$$y = \text{vco}(x, [Fmin Fmax], fs)$$

In this case, `vco` scales the frequency modulation range so values of `x` on the interval `[-1 1]` map to oscillations of frequency on `[Fmin Fmax]`.

If the input `x` is an array, `vco` produces an array whose columns oscillate according to the columns of `x`.

See “FFT-Based Time-Frequency Analysis” on page 7-28 for an example using the `vco` function.

## Deconvolution

*Deconvolution*, or polynomial division, is the inverse operation of convolution. Deconvolution is useful in recovering the input to a known filter, given the filtered output. This method is very sensitive to noise in the coefficients, however, so use caution in applying it.

The syntax for `deconv` is

```
[q,r] = deconv(b,a)
```

where `b` is the polynomial dividend, `a` is the divisor, `q` is the quotient, and `r` is the remainder.

To try `deconv`, first convolve two simple vectors `a` and `b`.

```
a = [1 2 3];  
b = [4 5 6];  
c = conv(a,b)  
c =  
    4    13    28    27    18
```

Now use `deconv` to deconvolve `b` from `c`:

```
[q,r] = deconv(c,a)  
q =  
    4    5    6  
r =  
    0    0    0    0    0
```

## Specialized Transforms

### In this section...

“Chirp  $z$ -Transform” on page 7-36

“Discrete Cosine Transform” on page 7-37

“Hilbert Transform” on page 7-40

“Walsh–Hadamard Transform” on page 7-41

### Chirp $z$ -Transform

The chirp  $z$ -transform (CZT), useful in evaluating the  $z$ -transform along contours other than the unit circle. The chirp  $z$ -transform is also more efficient than the DFT algorithm for the computation of prime-length transforms, and it is useful in computing a subset of the DFT for a sequence. The chirp  $z$ -transform, or CZT, computes the  $z$ -transform along spiral contours in the  $z$ -plane for an input sequence. Unlike the DFT, the CZT is not constrained to operate along the unit circle, but can evaluate the  $z$ -transform along contours described by

$$z_l = AW^{-l}, \quad l = 0, \dots, M-1$$

where  $A$  is the complex starting point,  $W$  is a complex scalar describing the complex ratio between points on the contour, and  $M$  is the length of the transform.

One possible spiral is

```
A = 0.8*exp(j*pi/6);
W = 0.995*exp(-j*pi*.05);
M = 91;
z = A*(W.^(-(0:M-1)));
zplane([],z.')
```

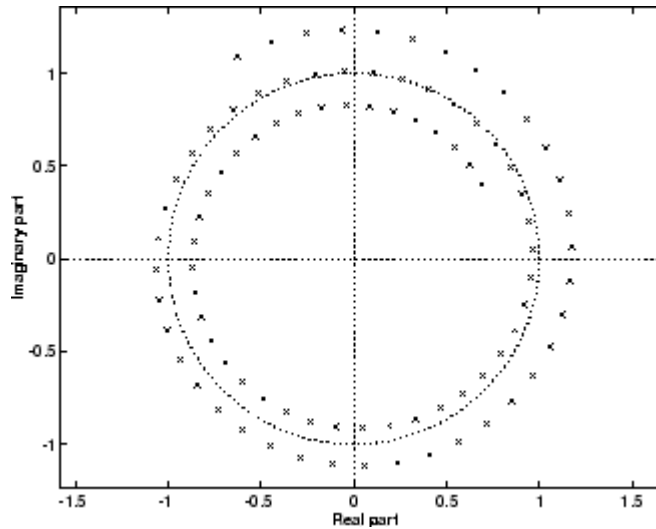

`czt(x,M,W,A)` computes the  $z$ -transform of  $x$  on these points.

An interesting and useful spiral set is  $m$  evenly spaced samples around the unit circle, parameterized by  $A = 1$  and  $W = \exp(-j\pi/M)$ . The  $z$ -transform on this contour is simply the DFT, obtained by

$$y = \text{czt}(x)$$

`czt` may be faster than the `fft` function for computing the DFT of sequences with certain odd lengths, particularly long prime-length sequences.

## Discrete Cosine Transform

The discrete cosine transform (DCT), closely related to the DFT. The DCT's energy compaction properties are useful for applications like signal coding. The toolbox function `dct` computes the unitary discrete cosine transform, or DCT, for an input vector or matrix. Mathematically, the unitary DCT of an input sequence  $x$  is

$$y(k) = w(k) \sum_{n=1}^N x(n) \cos \frac{\pi(2n-1)(k-1)}{2N}, \quad k = 1, \dots, N$$

where

$$w(k) = \begin{cases} \frac{1}{\sqrt{N}}, & k = 1 \\ \sqrt{\frac{2}{N}}, & 2 \leq k \leq N \end{cases}$$

The DCT is closely related to the discrete Fourier transform; the DFT is actually one step in the computation of the DCT for a sequence. The DCT, however, has better *energy compaction* properties, with just a few of the transform coefficients representing the majority of the energy in the sequence. The energy compaction properties of the DCT make it useful in applications such as data communications.

The function `idct` computes the inverse DCT for an input sequence, reconstructing a signal from a complete or partial set of DCT coefficients. The inverse discrete cosine transform is

$$x(n) = \sum_{k=1}^N w(k)y(k) \cos \frac{\pi(2n-1)(k-1)}{2N}, \quad n = 1, \dots, N$$

where

$$w(n) = \begin{cases} \frac{1}{\sqrt{N}}, & n = 1 \\ \sqrt{\frac{2}{N}}, & 2 \leq n \leq N \end{cases}$$

Because of the energy compaction mentioned above, it is possible to reconstruct a signal from only a fraction of its DCT coefficients. For example, generate a 25 Hz sinusoidal sequence, sampled at 1000 Hz:

```
t = (0:1/999:1);  
x = sin(2*pi*25*t);
```



Compute the DCT of this sequence and reconstruct the signal using only those components with value greater than 0.1 (64 of the original 1000 DCT coefficients):

```
y = dct(x) % Compute DCT
y2 = find(abs(y) < 0.9); % Use 17 coefficients
y(y2) = zeros(size(y2)); % Zero out points < 0.9
z = idct(y); % Reconstruct signal w/inverse DCT
```

Plot the original and reconstructed sequences:

```
subplot(2,1,1); plot(t,x);
title('Original Signal')
subplot(2,1,2); plot(t,z), axis([0 1 -1 1])
title('Reconstructed Signal')
```

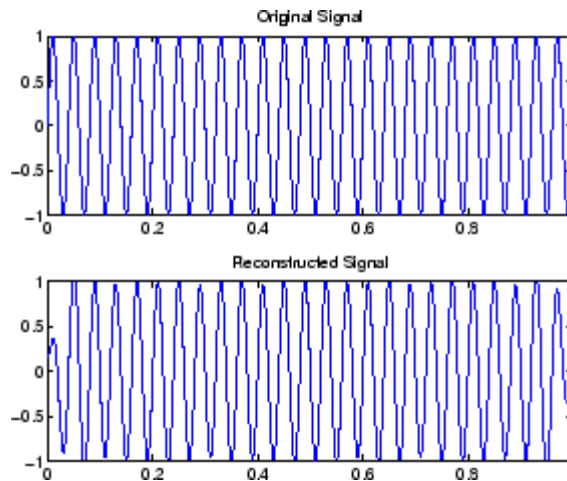

One measure of the accuracy of the reconstruction is

$$\text{norm}(x-z)/\text{norm}(x)$$

that is, the norm of the difference between the original and reconstructed signals, divided by the norm of the original signal. In this case, the relative error of reconstruction is 0.1443. The reconstructed signal retains approximately 85% of the energy in the original signal.

## Hilbert Transform

The Hilbert transform facilitates the formation of the analytic signal. The analytic signal is useful in the area of communications, particularly in bandpass signal processing. The toolbox function `hilbert` computes the Hilbert transform for a real input sequence `x` and returns a complex result of the same length

```
y = hilbert(x)
```

where the real part of `y` is the original real data and the imaginary part is the actual Hilbert transform. `y` is sometimes called the *analytic signal*, in reference to the continuous-time analytic signal. A key property of the discrete-time analytic signal is that its  $z$ -transform is 0 on the lower half of the unit circle. Many applications of the analytic signal are related to this property; for example, the analytic signal is useful in avoiding aliasing effects for bandpass sampling operations. The magnitude of the analytic signal is the complex envelope of the original signal.

The Hilbert transform is related to the actual data by a  $90^\circ$  phase shift; sines become cosines and vice versa. To plot a portion of data (solid line) and its Hilbert transform (dotted line):

```
t = (0:1/1023:1);  
x = sin(2*pi*60*t);  
y = hilbert(x);  
plot(t(1:50),real(y(1:50))), hold on  
plot(t(1:50),imag(y(1:50)),':');  
axis([0 0.05 -1.1 2]);  
legend('Real Part','Imaginary Part','location','northeast');
```

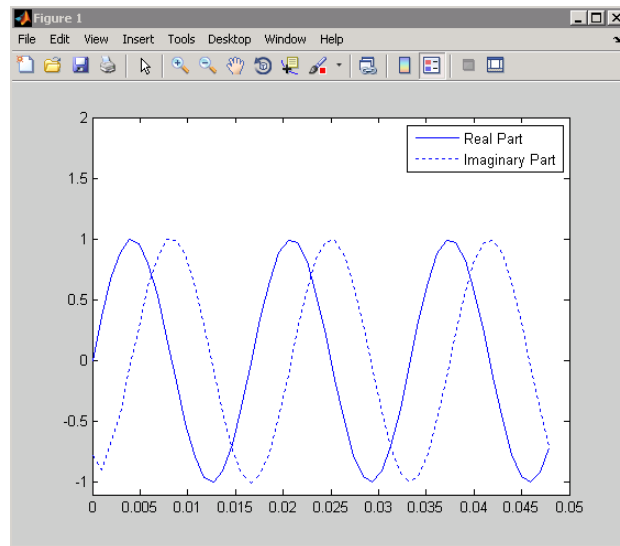

The analytic signal is useful in calculating *instantaneous attributes* of a time series, the attributes of the series at any point in time. The instantaneous amplitude of the input sequence is the amplitude of the analytic signal. The instantaneous phase angle of the input sequence is the (unwrapped) angle of the analytic signal; the instantaneous frequency is the time rate of change of the instantaneous phase angle. You can calculate the instantaneous frequency using the MATLAB function, `diff`.

## Walsh–Hadamard Transform

The Walsh–Hadamard transform is a non-sinusoidal, orthogonal transformation technique that decomposes a signal into a set of basis functions. These basis functions are Walsh functions, which are rectangular or square waves with values of +1 or -1. Walsh–Hadamard transforms are also known as Hadamard (see the `hadamard` function in the MATLAB software), Walsh, or Walsh-Fourier transforms.

The first eight Walsh functions have these values:

Index	Walsh Function Values
0	1 1 1 1 1 1 1 1
1	1 1 1 1 -1 -1 -1 -1
2	1 1 -1 -1 -1 -1 1 1
3	1 1 -1 -1 1 1 -1 -1
4	1 -1 -1 1 1 -1 -1 1
5	1 -1 -1 1 -1 1 1 -1
6	1 -1 1 -1 -1 1 -1 1
7	1 -1 1 -1 1 -1 1 -1

The Walsh–Hadamard transform returns sequency values. Sequency is a more generalized notion of frequency and is defined as one half of the average number of zero-crossings per unit time interval. Each Walsh function has a unique sequency value. You can use the returned sequency values to estimate the signal frequencies in the original signal.

Three different ordering schemes are used to store Walsh functions: sequency, Hadamard, and dyadic. Sequency ordering, which is used in signal processing applications, has the Walsh functions in the order shown in the table above. Hadamard ordering, which is used in controls applications, arranges them as 0, 4, 6, 2, 3, 7, 5, 1. Dyadic or gray code ordering, which is used in mathematics, arranges them as 0, 1, 3, 2, 6, 7, 5, 4.

The Walsh–Hadamard transform is used in a number of applications, such as image processing, speech processing, filtering, and power spectrum analysis. It is very useful for reducing bandwidth storage requirements and spread-spectrum analysis. Like the FFT, the Walsh–Hadamard transform has a fast version, the fast Walsh–Hadamard transform (fwht). Compared to the FFT, the FWHT requires less storage space and is faster to calculate because it uses only real additions and subtractions, while the FFT requires complex values. The FWHT is able to represent signals with sharp discontinuities more accurately using fewer coefficients than the FFT. Both the FWHT and the inverse FWHT (ifwht) are symmetric and thus, use identical calculation processes. The FWHT and IFWHT for a signal  $x(t)$  of length  $N$  are defined as:

$$y_n = \frac{1}{N} \sum_{i=0}^{N-1} x_i \text{WAL}(n, i)$$

$$x_i = \sum_{n=0}^{N-1} y_n \text{WAL}(n, i)$$

where  $i = 0, 1, \dots, N-1$  and  $\text{WAL}(n, i)$  are Walsh functions. Similar to the Cooley-Tukey algorithm for the FFT, the  $N$  elements are decomposed into two sets of  $N/2$  elements, which are then combined using a butterfly structure to form the FWHT. For images, where the input is typically a 2-D signal, the FWHT coefficients are calculated by first evaluating across the rows and then evaluating down the columns.

For the following simple signal, the resulting FWHT shows that  $x$  was created using Walsh functions with sequency values of 0, 1, 3, and 6, which are the non-zero indices of the transformed  $x$ . The inverse FWHT recreates the original signal.

```
x = [4 2 2 0 0 2 -2 0]
y = fwht(x)
y
    1    1    0    1    0    0    1    0

x1 = ifwht(y)
x1
    4    2    2    0    0    2   -2    0
```

### Using Walsh-Hadamard Transform for Spectral Analysis and Compression of ECG Signals

The following example uses an electrocardiogram (ECG) signal to illustrate working with the Walsh-Hadamard transform. ECG signals typically are very large and need to be stored for analysis and retrieval at a future time. Walsh-Hadamard transforms are particularly well-suited to this application because they provide compression and thus, require less storage space, plus they also provide rapid signal reconstruction.

Start with an ECG signal. For this example, we replicate it to create a longer signal and insert some additional random noise. Then, transform the signal

using the fast Walsh-Hadamard transform and plot the original signal and the transformed signal.

```
xe = ecg(512); % Single ecg wave
xr = repmat(xe,1,8); % Replicate it to create more data
x = xr + 0.1.*randn(1,length(xr)); % Add noise

% Fast Walsh-Hadamard transform. Use default values
% for the number of points to use for the transform and
% for the ordering - sequency -- why???
```

```
y = fwht(x);
figure('color','white');
subplot(2,1,1);
plot(x); % Plot original noisy signal
xlabel('Sample index');
ylabel('Amplitude');
title('ECG Signal');
subplot(2,1,2);
plot(abs(y)) % Plot magnitude of transformed signal
xlabel('Sequency index');
ylabel('Magnitude');
title('WHT Coefficients');
```

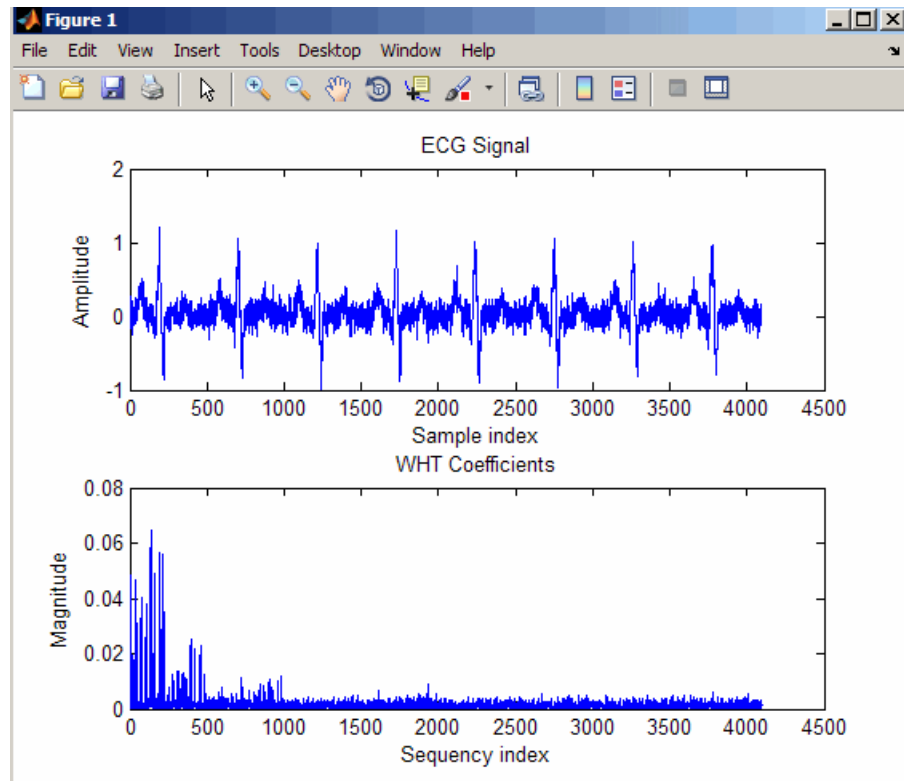

The plot shows that most of the signal energy is in the lower frequency values below approximately 1100. We will store only the first 1024 coefficients and see if the signal can be accurately reconstructed from only these stored coefficients.

```

y(1025:length(x)) = 0;           % Zeroing out the higher coefficients
xHat = ifwht(y);                 % Signal reconstruction using inverse WHT
figure('color','white');
plot(x);
hold on
plot(xHat,'r');
xlabel('Sample index');
ylabel('ECG signal amplitude');
legend('Original Signal','Reconstructed Signal');

```

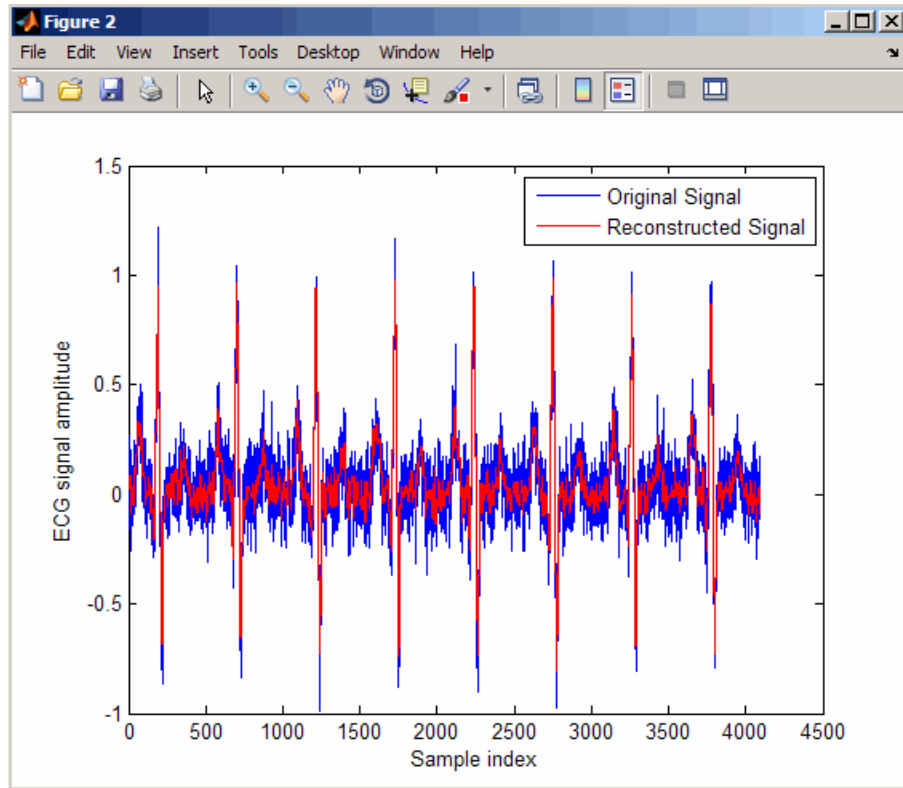

The reproduced signal is very close to the original signal.

To reconstruct the original signal, we stored only the first 1024 coefficients and the ECG signal length. This represents a compression ratio of approximately 4:1. Storing more coefficients is a tradeoff between increased resolution and increased noise, while storing fewer coefficients may cause loss of peaks.

```
req = [length(x) y(1:1024)];
whos x req
```

Name	Size	Bytes	Class	Attributes
req	1x1025	8200	double	
x	1x4096	32768	double	



## Selected Bibliography

- [1] Kay, S.M. *Modern Spectral Estimation*. Englewood Cliffs, NJ: Prentice Hall, 1988.
- [2] Oppenheim, A.V., and R.W. Schafer. *Discrete-Time Signal Processing*. Englewood Cliffs, NJ: Prentice Hall, 1989.
- [3] Oppenheim, A.V., and R.W. Schafer. *Discrete-Time Signal Processing*. Englewood Cliffs, NJ: Prentice Hall, 1975, Section 10.5.3.
- [4] Parks, T.W., and C.S. Burrus. *Digital Filter Design*. New York: John Wiley & Sons, 1987.
- [5] Pratt, W.K. *Digital Image Processing*. New York: John Wiley & Sons, 1991.



# SPTool: A Signal Processing GUI Suite

---

- “SPTool: An Interactive Signal Processing Environment” on page 8-2
- “Opening SPTool” on page 8-4
- “Getting Context-Sensitive Help” on page 8-6
- “Signal Browser” on page 8-7
- “FDATool” on page 8-10
- “Filter Visualization Tool” on page 8-11
- “Spectrum Viewer” on page 8-13
- “Filtering and Analysis of Noise” on page 8-16
- “Exporting Signals, Filters, and Spectra” on page 8-27
- “Accessing Filter Parameters” on page 8-29
- “Importing Filters and Spectra” on page 8-32
- “Loading Variables from the Disk” on page 8-36
- “Saving and Loading Sessions” on page 8-37
- “Selecting Signals, Filters, and Spectra” on page 8-39
- “Editing Signals, Filters, or Spectra” on page 8-40
- “Making Signal Measurements with Markers” on page 8-41
- “Setting Preferences” on page 8-43
- “Using the Filter Designer” on page 8-47

## SPTool: An Interactive Signal Processing Environment

In this section...
“SPTool Overview” on page 8-2
“SPTool Data Structures” on page 8-3

### SPTool Overview

SPTool is an interactive GUI for digital signal processing used to

- Analyze signals
- Design filters
- Analyze (view) filters
- Filter signals
- Analyze signal spectra

You can accomplish these tasks using four GUIs that you access from within SPTool:

- The “Signal Browser” on page 8-7 is for analyzing signals. You can also play signals using your computer’s audio hardware.
- `fdatool` is available for designing or editing FIR and IIR digital filters. Most Signal Processing Toolbox filter design methods available at the command line are also available in FDATool. Additionally, you can use FDATool to design a filter by using the “Pole/Zero Editor” on page 8-48 to graphically place poles and zeros on the  $z$ -plane.
- The “Filter Visualization Tool” on page 8-11 (FVTool) is for analyzing filter characteristics.
- The “Spectrum Viewer” on page 8-13 is for spectral analysis. You can use Signal Processing Toolbox spectral estimation methods to estimate the power spectral density of a signal.

## SPTool Data Structures

You can use SPTool to analyze signals, filters, or spectra that you create at the MATLAB command line.

You can bring signals, filters, or spectra from the MATLAB workspace into the SPTool workspace using **File > Import**. For more information, see “Importing Filters and Spectra” on page 8-32. Signals, filters, or spectra that you create in (or import into) the SPTool workspace exist as MATLAB structures. See the MATLAB documentation for more information on MATLAB structures.

When you use **File > Export** to save signals, filters, and spectra that you create or modify in SPTool, these are also saved as MATLAB structures. For more information on exporting, see “Exporting Signals, Filters, and Spectra” on page 8-27.

## Opening SPTool

To open SPTool, type

```
sptool
```

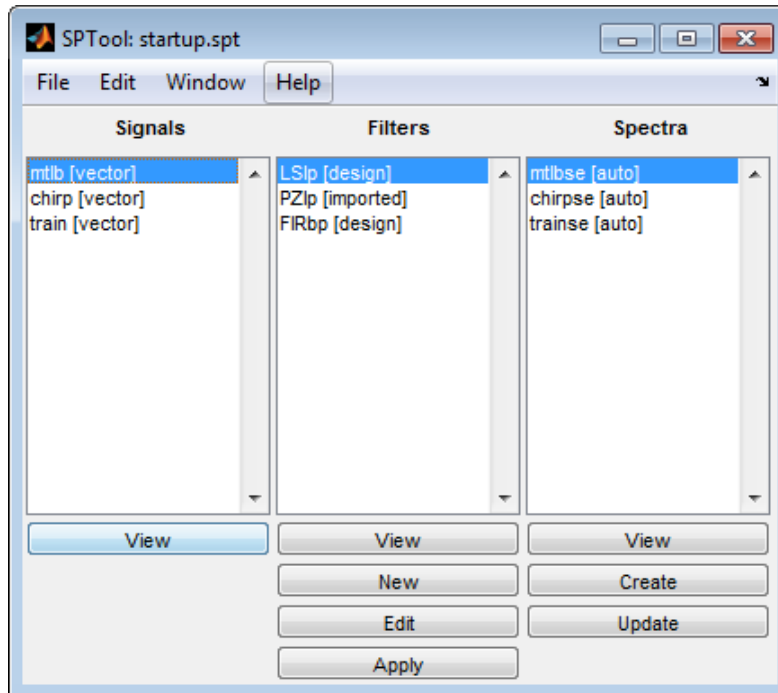

When you first open SPTool, it contains a collection of default signals, filters, and spectra. To specify your own preferences for what signals, filters, and spectra to see when SPTool opens see “Setting Preferences” on page 8-43.

You can access these three GUIs from SPTool by selecting a signal, filter, or spectrum and clicking the appropriate **View** button:

- Signal Browser
- Filter Visualization Tool
- Spectrum Viewer

You can access FDATool by clicking **New** to create a new filter or **Edit** to edit a selected filter. Clicking **Apply** applies a selected filter to a selected signal.

**Create** opens the Spectrum Viewer and creates the power spectral density of the selected signal. **Update** opens the Spectrum Viewer for the selected spectrum.

## Getting Context-Sensitive Help

To find information on a particular feature or setting of the “Signal Browser” on page 8-7:

- In any Measurements panel, right-click anywhere on the panel and select **What’s this?**.
- In any dialog box where you see the  icon in the lower left corner, right-click on any parameter and select **What’s this?**.

To find information on a particular region of “FDATool” on page 8-10 or “Spectrum Viewer” on page 8-13:

**1** Click **What’s this?** .

**2** Click on the region of the GUI you want information on.

You can also use **Help > What’s This?** to launch context-sensitive help.



# Signal Browser

In this section...
“Overview of the Signal Browser” on page 8-7
“Opening the Signal Browser” on page 8-7

## Overview of the Signal Browser

You can use the Signal Browser to display and analyze signals listed in the **Signals** list box in SPTool.

Using the Signal Browser, you can:

- Analyze and compare vector or array (matrix) signals.
- Zoom in on portions of signal data.
- Measure a variety of characteristics of signal data.
- Compare multiple signals.
- Play portions of signal data on audio hardware.
- Print signal plots.

## Opening the Signal Browser



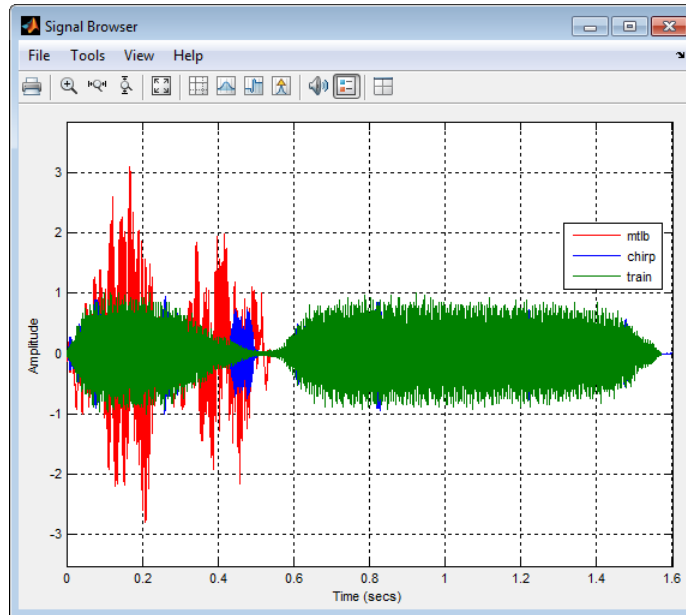

To open the Signal Browser from SPTool:





- 1** Select one or more signals in the **Signals** list in SPTool.
- 2** Click **View** under the **Signals** list.



The Signal Browser has the following components:

- A display region for analyzing signals
- A panels section on the right side of the scope window, which shows statistics and information about your signals
- A toolbar with buttons for convenient access to frequently used functions

Icon	Description
	Print the current scope window.
	Play an audio signal. The function <code>soundsc</code> is used to play the signal.
	Show multiple displays of signals.
	Zoom the signal in and out.

Icon	Description
	Scale the axes.
	Toggle the legends on and off.
	Toggle the Cursor Measurements panel. This panel allows you to see screen cursors and get measurements of time and amplitude values at the cursors.
	Toggle the Signal Statistics, Bilevel Measurements, and Peak Finder panels, which display various measurements about the selected signal.

For more information on the Signal Browser, see the `sptool` function reference page.

## FDATool

You can use the Filter Design and Analysis Tool (fdatool) to design and edit filters.

To open FDATool from SPTool, click **New** under the **Filters** list to create a new filter or select one of the filters in the **Filters** list in SPTool and click **Edit** to edit that filter.

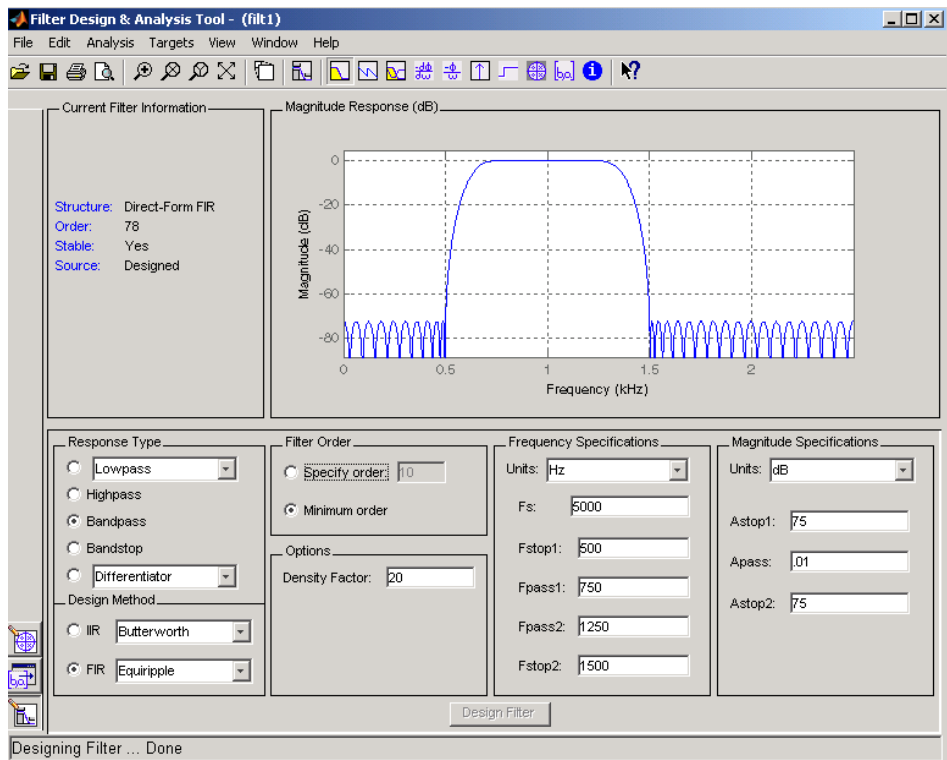

**Note** When you open FDATool from SPTool, a reduced version of FDATool that is compatible with SPTool opens.

## Filter Visualization Tool

In this section...
“Connection between FVTool and SPTool” on page 8-11
“Opening the Filter Visualization Tool” on page 8-11
“Analysis Parameters” on page 8-12

### Connection between FVTool and SPTool

You can use the Filter Visualization Tool to analyze response characteristics of the selected filter(s). See `fvtool` for detailed information about FVTool.

If you start FVTool by clicking the SPTool **Filter View** button, that FVTool is linked to SPTool. Any changes made in SPTool to the filter are immediately reflected in FVTool. The FVTool title bar includes "SPTool" to indicate the link.

If you start an FVTool by clicking the **New** button or by selecting **File > New** from within FVTool, that FVTool is a standalone version and is not linked to SPTool.

---

**Note** Every time you click the **Filter View** button a new, linked FVTool starts. This allows you to view multiple analyses simultaneously.

---

### Opening the Filter Visualization Tool

You open FVTool from SPTool as follows.

- 1 Select one or more filters in the **Filters** list in SPTool.
- 2 Click the **View** button under the **Filters** list.

When you first open FVTool, it displays the selected filter's magnitude plot.

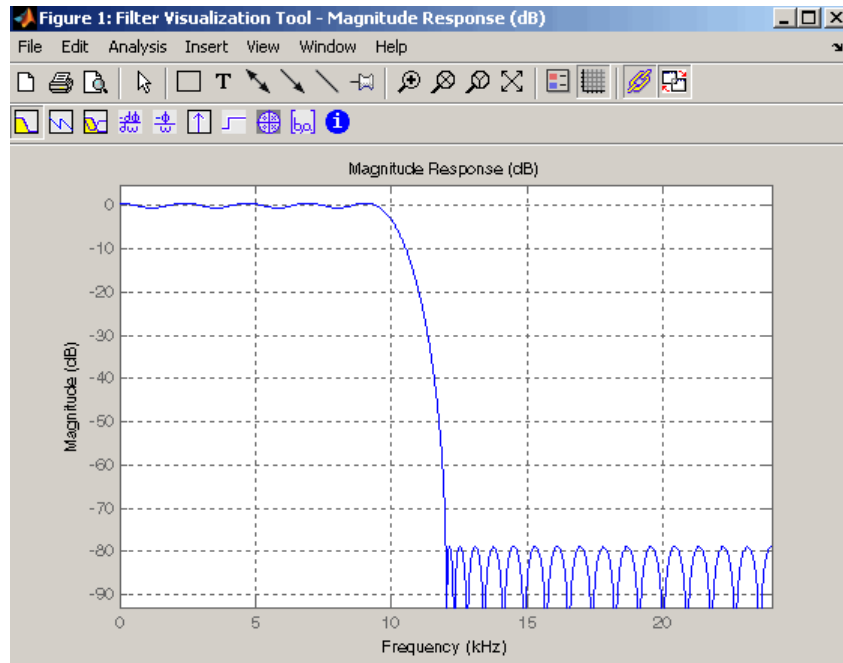

## Analysis Parameters

In the plot area of any filter response plot, right-click and select **Analysis Parameters** to display details about the displayed plot. See “Analysis Parameters” in the FDATool online help for more information.

You can change any parameter in a linked FVTool, except the sampling frequency. You can only change the sampling frequency using the SPTool **Edit > Sampling Frequency** or the SPTool **Filters Edit** button.

# Spectrum Viewer

## In this section...

“Spectrum Viewer Overview” on page 8-13

“Opening the Spectrum Viewer” on page 8-13

## Spectrum Viewer Overview

You can use the Spectrum Viewer for estimating and analyzing a signal’s power spectral density (PSD). You can use the PSD estimates to understand a signal’s frequency content.

The Spectrum Viewer provides the following functionality.

- Analyze and compare spectral density plots.
- Use different spectral estimation methods to create spectra:
  - Burg (pburg)
  - Covariance (pcov)
  - FFT (fft)
  - Modified covariance (pmcov)
  - MTM (multitaper method) (pmtm)
  - MUSIC (pmusic)
  - Welch (pwelch)
  - Yule-Walker AR (pyulear)
- Modify power spectral density parameters such as FFT length, window type, and sample frequency.
- Print spectral plots.

## Opening the Spectrum Viewer

To open the Spectrum Viewer and create a PSD estimate from SPTool:

- 1 Select a signal from the **Signal** list box in SPTool.

2 Click **Create** in the **Spectra** list.

3 Click **Apply** in the Spectrum Viewer.

To open the Spectrum Viewer with a PSD estimate already listed in SPTool:

1 Select a PSD estimate from the **Spectra** list box in SPTool.

2 Click **View** in the Spectra list.

For example:

1 Select `mt1b` in the default **Signals** list in SPTool.

2 Click **Create** in SPTool to open the Spectrum Viewer.

3 Click **Apply** in the Spectrum Viewer to plot the spectrum.

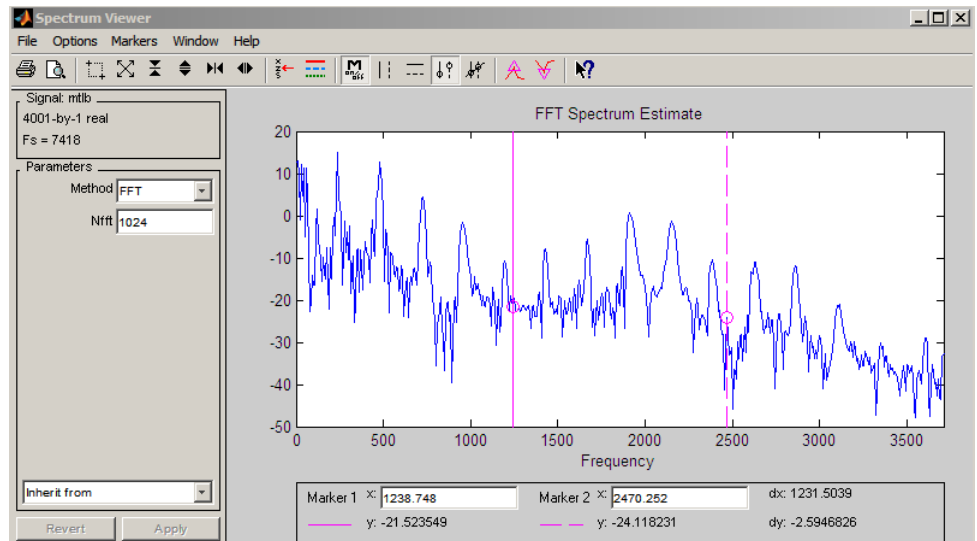







The Spectrum Viewer has the following components:

- A signal identification region that provides information about the signal whose power spectral density estimate is displayed



- A Parameters region for modifying the PSD parameters
- A display region for analyzing spectra and an **Options** menu for modifying display characteristics
- Spectrum management controls
  - **Inherit from** menu to inherit PSD specifications from another PSD object listed in the menu
  - Revert button to revert to the named PSD's original specifications
  - **Apply** button for creating or updating PSD estimates
- A toolbar with buttons for convenient access to frequently used functions

Icon	Description
	Print and print preview
	Zoom the signal in and out
	Select one of several loaded signals
	Set the display color and line style of a signal
	Toggle the markers on and off
	Set marker types
	Turn on the What's This help

## Filtering and Analysis of Noise

In this section...
“Overview” on page 8-16
“Importing a Signal into SPTool” on page 8-16
“Designing a Filter” on page 8-18
“Applying a Filter to a Signal” on page 8-20
“Analyzing a Signal” on page 8-22
“Spectral Analysis in the Spectrum Viewer” on page 8-24

### Overview

The following sections provide an example of using the GUI-based interactive tools to:

- Design and implement an FIR bandpass digital filter
- Apply the filter to a noisy signal
- Analyze signals and their spectra

The steps include:

- 1** “Importing a Signal into SPTool” on page 8-16
- 2** Designing a bandpass filter using FDATool
- 3** Applying the filter to the original noise signal to create a bandlimited noise signal
- 4** Comparing the time domain information of the original and filtered signals using the Signal Browser
- 5** Comparing the spectra of both signals using the Spectrum Viewer

### Importing a Signal into SPTool

To import a signal into SPTool from the workspace or disk, the signal must be either:

- A special MATLAB signal structure, such as that saved from a previous SPTool session
- A signal created as a variable (vector or matrix) in the MATLAB workspace

For this example, create a new signal at the command line and then import it as a structure into SPTool:

- 1 Create a random signal in the MATLAB workspace by typing

```
x = randn(5000,1);
```

- 2 If SPTool is not already open, open SPTool by typing

```
sptool
```

The SPTool window is displayed.

- 3 Select **File > Import**. The Import to SPTool dialog opens.

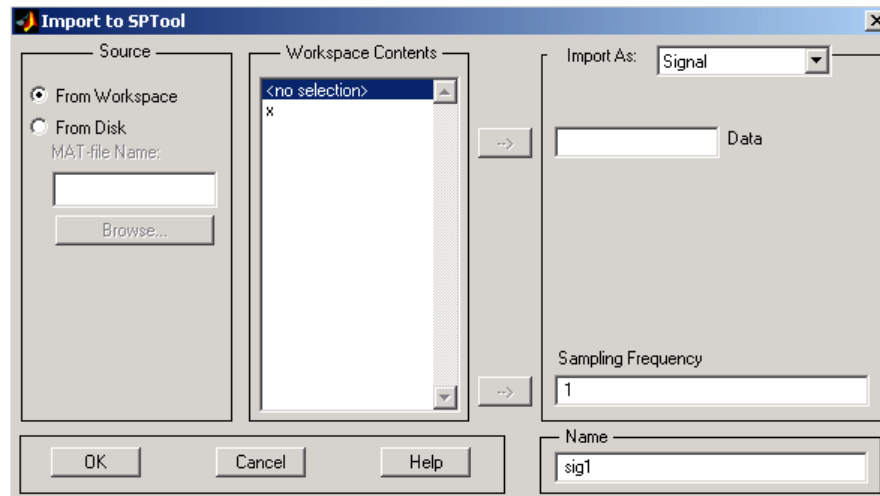

The variable **x** is displayed in the **Workspace Contents** list. (If it is not, select the **From Workspace** radio button to display the contents of the workspace.)

- 4 Select the signal and import it into the **Data** field:

- a** Select the signal variable `x` in the **Workspace Contents** list.
- b** Make sure that **Signal** is selected in the **Import As** pull-down menu.
- c** Click on the arrow to the left of the **Data** field or type `x` in the **Data** field.
- d** Type 5000 in the **Sampling Frequency** field.
- e** Name the signal by typing `noise` in the **Name** field.
- f** Click **OK**.

The signal `noise[vector]` appears and is selected in SPTool's **Signals** list.

---

**Note** You can import filters and spectra into SPTool in much the same way as you import signals. See “Importing Filters and Spectra” on page 8-32 for specific details.

You can also import signals from MAT-files on your disk, rather than from the workspace. See “Loading Variables from the Disk” on page 8-36 for more information.

Type `help sptool` for information about importing from the command line.

---

## Designing a Filter

You can import an existing filter into SPTool, or you can design and edit a new filter using FDATool.

In this example, you

- 1** Open a default filter in FDATool.
- 2** Specify an equiripple bandpass FIR filter.

## Opening FDATool

To open FDATool, click **New** in SPTool. FDATool opens with a default filter named `filt1`.

## Specifying the Bandpass Filter

Design an equiripple bandpass FIR filter with the following characteristics:

- Sampling frequency of 5000 Hz
- Stopband frequency ranges of [0 500] Hz and [1500 2500] Hz
- Passband frequency range of [750 1250] Hz
- Ripple in the passband of 0.01 dB
- Stopband attenuation of 75 dB

To modify the filter in FDATool to meet these specifications, you need to

- 1 Select Bandpass from the **Response Type** list.
- 2 Verify that **FIR Equiripple** is selected as the **Design Method**.
- 3 Verify that **Minimum order** is selected as the **Filter Order** and that the **Density Factor** is set to 20.
- 4 Under **Frequency Specifications**, set the sampling frequency (**Fs**) and the passband (**Fpass1**, **Fpass2**) and stopband (**Fstop1**, **Fstop2**) edges:

Units	Hz
<b>Fs</b>	5000
<b>Fstop1</b>	500
<b>Fpass1</b>	750
<b>Fpass2</b>	1250
<b>Fstop2</b>	1500

- 5 Under **Magnitude Specifications**, set the stopband attenuation (**Astop1**, **Astop2**) and the maximum passband ripple (**Apass**):

Units	dB
Astop1	75
Apass	0.01
Astop2	75

- 6 Click **Design Filter** to design the new filter. When the new filter is designed, the magnitude response of the filter is displayed.

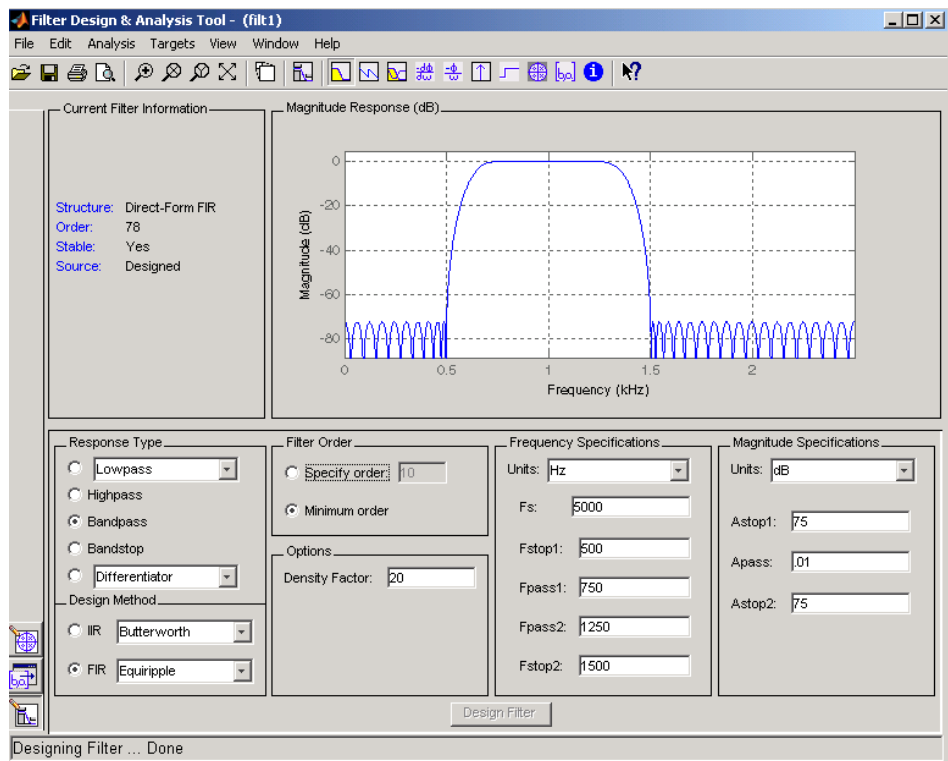

The resulting filter is an order-78 bandpass equiripple filter.

## Applying a Filter to a Signal

When you apply a filter to a signal, you create a new signal in SPTool representing the filtered signal.

To apply the filter `filt1` you just created to the signal `noise`,

- 1 In SPTool, select the signal `noise[vector]` from the **Signals** list and select the filter (named `filt1[design]`) from the **Filters** list.

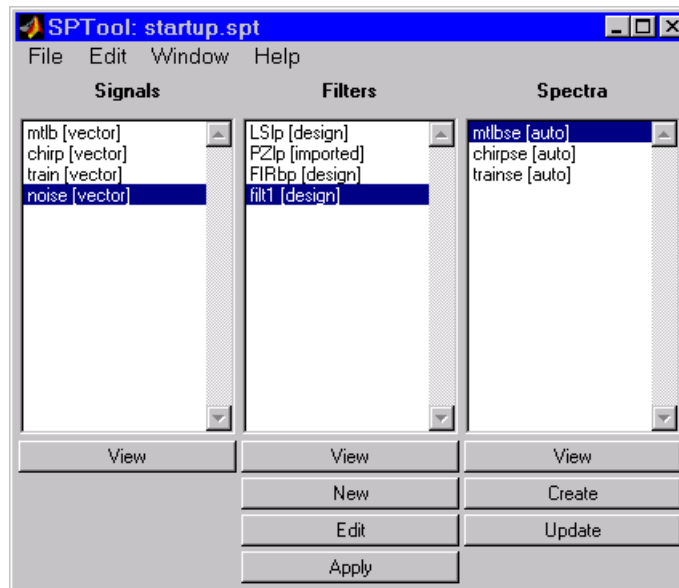

- 2 Click **Apply** under the **Filters** list.

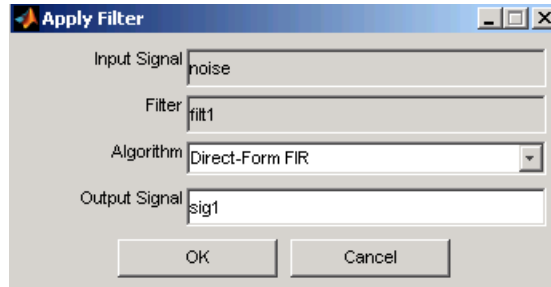

- 3 Leave the **Algorithm** as Direct-Form FIR.

---

**Note** You can apply one of two filtering algorithms to FIR filters. The default algorithm is specific to the filter structure, which is shown in the FDATool Current Filter Info frame. Alternately for FIR filters, FFT based FIR (`fftfilt`) uses the algorithm described in `fftfilt`.

For IIR filters, the alternate algorithm is a zero-phase IIR that uses the algorithm described in `filtfilt`.

---

**4** Enter `blnoise` as the **Output Signal** name.

**5** Click **OK** to close the Apply Filter dialog box.

The filter is applied to the selected signal, and the filtered signal `blnoise[vector]` is listed in the **Signals** list in SPTool.

## Analyzing a Signal

You can analyze and print signals using the Signal Browser. You can also play the signals if your computer has audio output capabilities.

For example, compare the signal `noise` to the filtered signal `blnoise`:

**1** **Shift**+click on the `noise` and `blnoise` signals in the **Signals** list of SPTool to select both signals.

**2** Click **View** under the **Signals** list.

The Signal Browser is activated, and both signals are displayed in the display region. (The names of both signals are shown above the display region.) Initially, the original `noise` signal covers up the bandlimited `blnoise` signal.

**3** Push the selection button  on the toolbar to select the `blnoise` signal.



The display area is updated. Now you can see the `blnoise` signal superimposed on top of the `noise` signal. The signals are displayed in different colors in both the display region and the panner. You can change the color of the selected signal using the *Line Properties* button on the toolbar, .

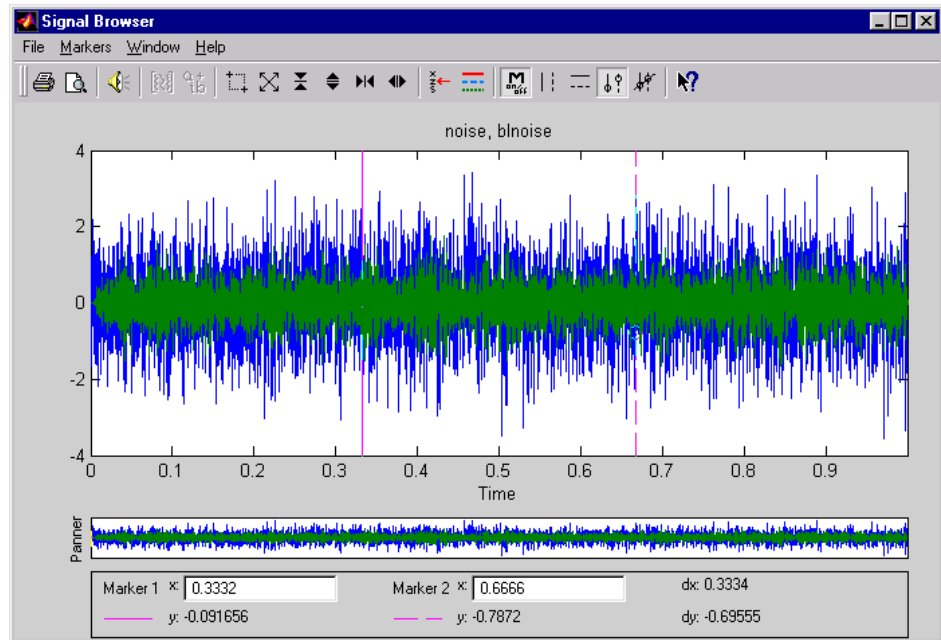



## Playing a Signal

When you click **Play** in the Signal Browser toolbar, , the active signal is played on the computer's audio hardware:

- 1** To hear a portion of the active (selected) signal
  - a** Use the vertical markers to select a portion of the signal you want to play. Vertical markers are enabled by the  and  buttons.
  - b** Click **Play**.
- 2** To hear the other signal
  - a** Select the signal as in step above. You can also select the signal directly in the display region.
  - b** Click **Play** again.

## Printing a Signal

You can print from the Signal Browser using the **Print** button, .

You can use the line display buttons to maximize the visual contrast between the signals by setting the line color for noise to gray and the line color for blnoise to white. Do this before printing two signals together.

---

**Note** You can follow the same rules to print spectra, but you can't print filter responses directly from SPTool.

---

Use the Signal Browser region in the Preferences dialog box in SPTool to suppress printing of both the panner and the marker settings.

To print both signals, click **Print** in the Signal Browser toolbar.

## Spectral Analysis in the Spectrum Viewer

You can analyze the frequency content of a signal using the Spectrum Viewer, which estimates and displays a signal's power spectral density.

For example, to analyze and compare the spectra of noise and blnoise:

- 1 Create a power spectral density (PSD) object, `spect1`, that is associated with the signal `noise`, and a second PSD object, `spect2`, that is associated with the signal `blnoise`.
- 2 Open the Spectrum Viewer to analyze both of these spectra.
- 3 Print both spectra.

## Creating a PSD Object From a Signal

- 1 Click on SPTool, or select **Window > SPTool** in any active open GUI. SPTool is now the active window.
- 2 Select the `noise[vector]` signal in the **Signals** list of SPTool.

- 3 Click **Create** in the **Spectra** list.

The Spectrum Viewer is activated, and a PSD (`spect1`) corresponding to the `noise` signal is created in the **Spectra** list. The PSD is not computed or displayed yet.

- 4 Click **Apply** in the Spectrum Viewer to compute and display the PSD estimate `spect1` using the default parameters.

The PSD of the `noise` signal is displayed in the display region. The identifying information for the PSD's associated signal (`noise`) is displayed above the Parameters region.

The PSD estimate `spect1` is within 2 or 3 dB of 0, so the noise has a fairly "flat" power spectral density.

- 5 Follow steps 1 through 4 for the bandlimited noise signal `blnoise` to create a second PSD estimate `spect2`.

The PSD estimate `spect2` is flat between 750 and 1250 Hz and has 75 dB less power in the stopband regions of `filt1`.

## Opening the Spectrum Viewer with Two Spectra

- 1 Reactivate SPTool again, as in step 1 above.
- 2 **Shift+click** on `spect1` and `spect2` in the **Spectra** list to select them both.
- 3 Click **View** in the **Spectra** list to reactivate the Spectrum Viewer and display both spectra together.

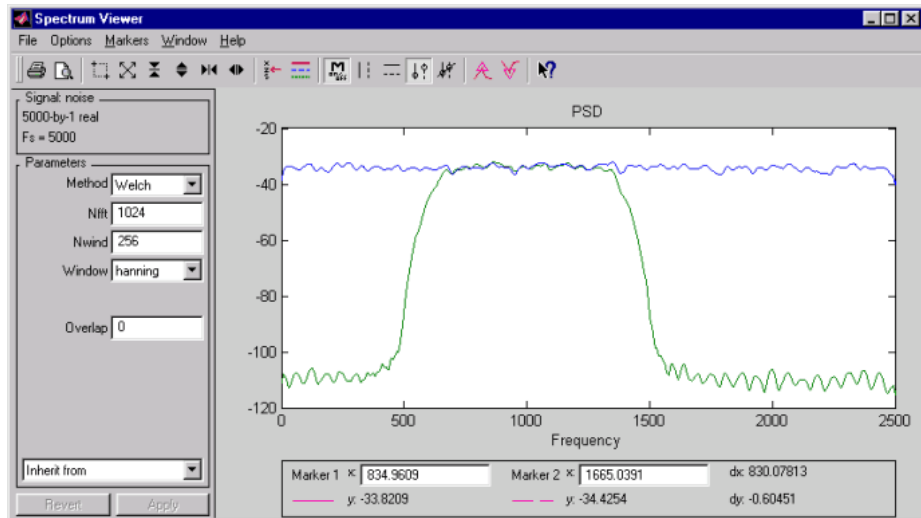

## Printing the Spectra

Before printing the two spectra together, use the color and line style selection button, , to differentiate the two plots by line style, rather than by color.

To print both spectra:

- 1 Click **Print Preview**  in the toolbar on the Spectrum Viewer.
- 2 From the Spectrum Viewer Print Preview window, drag the legend out of the display region so that it doesn't obscure part of the plot.
- 3 Click **Print** in the Spectrum Viewer Print Preview window.

## Exporting Signals, Filters, and Spectra

### In this section...

“Opening the Export Dialog Box” on page 8-27

“Exporting a Filter to the MATLAB Workspace” on page 8-28

### Opening the Export Dialog Box

To save the filter `filt1` you just created in this example, open the Export dialog box with `filt1` preselected:

- 1 Select `filt1` in the SPTool **Filters** list.
- 2 Select **File > Export**.

The Export dialog box opens with `filt1` preselected.

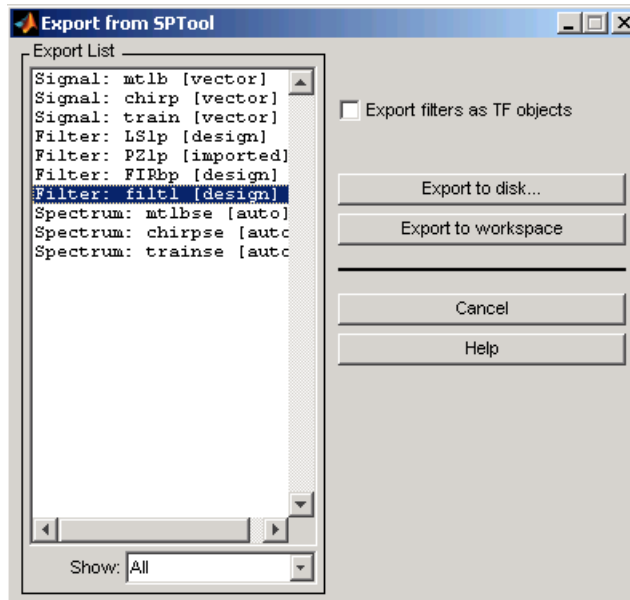

## **Exporting a Filter to the MATLAB Workspace**

To export the filter `filt1` to the MATLAB workspace:

- 1** Select `filt1` from the **Export List** and deselect all other items using **Ctrl+click**.
- 2** Click **Export to Workspace**.

## Accessing Filter Parameters

### In this section...

“Accessing Filter Parameters in a Saved Filter” on page 8-29

“Accessing Parameters in a Saved Spectrum” on page 8-30

### Accessing Filter Parameters in a Saved Filter

The MATLAB structures created by SPTool have several associated fields, many of which are also MATLAB structures. See the MATLAB documentation for general information about MATLAB structures.

For example, after exporting a filter `filt1` to the MATLAB workspace, type

```
filt1
```

to display the fields of the MATLAB filter structure. The `tf` field of the structure contains information that describes the filter.

#### The `tf` Field: Accessing Filter Coefficients

The `tf` field is a structure containing the transfer function representation of the filter. Use this field to obtain the filter coefficients;

- `filt1.tf.num` contains the numerator coefficients.
- `filt1.tf.den` contains the denominator coefficients.

The vectors contained in these structures represent polynomials in descending powers of  $z$ . The numerator and denominator polynomials are used to specify the transfer function

$$H(z) = \frac{B(z)}{A(z)} = \frac{b(1) + b(2)z^{-1} + \dots + b(nb+1)z^{-m}}{a(1) + a(2)z^{-1} + \dots + a(na+1)z^{-n}}$$

where:

- $b$  is a vector containing the coefficients from the `tf.num` field.

- $a$  is a vector containing the coefficients from the `tf.den` field.
- $m$  is the numerator order.
- $n$  is the denominator order.

You can change the filter representation from the default transfer function to another form by using the `tf2ss` or `tf2zp` functions.

---

**Note** The `FDAspecs` field of your filter contains internal information about `FDATool` and should not be changed.

---

## Accessing Parameters in a Saved Spectrum

The following structure fields describe the spectra saved by SPTool.

Field	Description
<code>P</code>	The spectral power vector.
<code>f</code>	The spectral frequency vector.
<code>confid</code>	<p>A structure containing the confidence intervals data</p> <ul style="list-style-type: none"> <li>• The <code>confid.level</code> field contains the chosen confidence level.</li> <li>• The <code>confid.Pc</code> field contains the spectral power data for the confidence intervals.</li> <li>• The <code>confid.enable</code> field contains a 1 if confidence levels are enabled for the power spectral density.</li> </ul>
<code>signalLabel</code>	The name of the signal from which the power spectral density was generated.
<code>Fs</code>	The associated signal's sample rate.

You can access the information in these fields as you do with every MATLAB structure.

For example, if you export an SPTool PSD estimate `spect1` to the workspace, type



`spect1.P`

to obtain the vector of associated power values.

## Importing Filters and Spectra

### In this section...

“Similarities to Other Procedures” on page 8-32

“Importing Filters” on page 8-32

“Importing Spectra” on page 8-34

### Similarities to Other Procedures

The procedures are very similar to those explained in

- “Importing a Signal into SPTool” on page 8-16 for loading variables from the workspace
- “Loading Variables from the Disk” on page 8-36 for loading variables from your disk

### Importing Filters

When you import filters, first select the appropriate filter form from the **Form** list. SPTool does not currently support the import of filter objects.

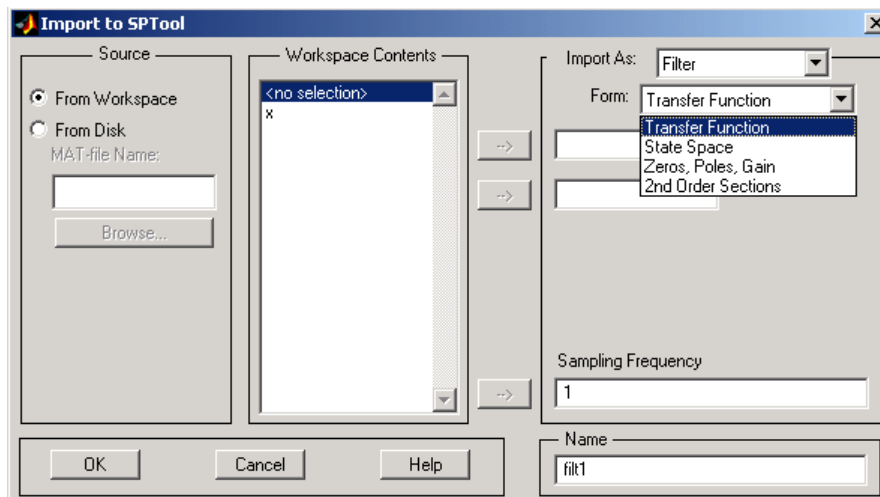

For every filter you specify a variable name or a value for the filter's sampling frequency in the **Sampling Frequency** field. Each filter form requires different variables.

### Transfer Function

For Transfer Function, you specify the filter by its transfer function representation:

$$H(z) = \frac{B(z)}{A(z)} = \frac{b(1) + b(2)z^{-1} + \dots + b(m+1)z^{-m}}{a(1) + a(2)z^{-1} + \dots + a(n+1)z^{-n}}$$

- The **Numerator** field specifies a variable name or value for the numerator coefficient vector  $b$ , which contains  $m+1$  coefficients in descending powers of  $z$ .
- The **Denominator** field specifies a variable name or value for the denominator coefficient vector  $a$ , which contains  $n+1$  coefficients in descending powers of  $z$ .

### State Space

For State Space, you specify the filter by its state-space representation:

$$\begin{aligned}\dot{x} &= Ax + Bu \\ y &= Cx + Du\end{aligned}$$

The **A-Matrix**, **B-Matrix**, **C-Matrix**, and **D-Matrix** fields specify a variable name or a value for each matrix in this system.

### Zeros, Poles, Gain

For Zeros, Poles, Gain, you specify the filter by its zero-pole-gain representation:

$$H(z) = \frac{Z(z)}{P(z)} = k \frac{(z - z(1))(z - z(2)) \dots (z - z(m))}{(z - p(1))(z - p(2)) \dots (z - p(n))}$$

- The **Zeros** field specifies a variable name or value for the zeros vector  $z$ , which contains the locations of  $m$  zeros.
- The **Poles** field specifies a variable name or value for the zeros vector  $p$ , which contains the locations of  $n$  poles.
- The **Gain** field specifies a variable name or value for the gain  $k$ .

### Second Order Sections

For 2nd Order Sections you specify the filter by its second-order section representation:

$$H(z) = \prod_{k=1}^L H_k(z) = \prod_{k=1}^L \frac{b_{0k} + b_{1k}z^{-1} + b_{2k}z^{-2}}{1 + a_{1k}z^{-1} + a_{2k}z^{-2}}$$

The **SOS Matrix** field specifies a variable name or a value for the  $L$ -by-6 SOS matrix

$$sos = \begin{bmatrix} b_{01} & b_{11} & b_{21} & 1 & a_{11} & a_{21} \\ b_{02} & b_{12} & b_{22} & 1 & a_{12} & a_{22} \\ \vdots & \vdots & \vdots & \vdots & \vdots & \vdots \\ b_{0L} & b_{1L} & b_{2L} & 1 & a_{1L} & a_{2L} \end{bmatrix}$$

whose rows contain the numerator and denominator coefficients  $b_{ik}$  and  $a_{ik}$  of the second-order sections of  $H(z)$ .

---

**Note** If you import a filter that was not created in SPTool, you can only edit that filter using the Pole/Zero Editor.

---

### Importing Spectra

When you import a power spectral density (PSD), you specify:

- A variable name or a value for the PSD vector in the **PSD** field
- A variable name or a value for the frequency vector in the **Freq. Vector** field

The PSD values in the **PSD** vector correspond to the frequencies contained in the **Freq. Vector** vector; the two vectors must have the same length.

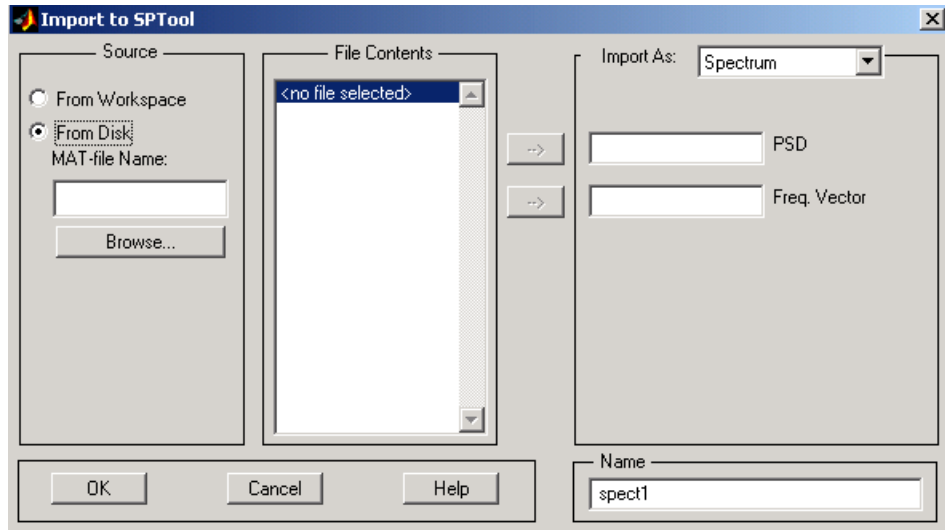

## Loading Variables from the Disk

To import variables representing signals, filters, or spectra from a MAT-file on your disk;

- 1** Select the **From Disk** radio button and do either of the following:
  - Type the name of the file you want to import into the **MAT-file Name** field and press either the **Tab** or the **Enter** key on your keyboard.
  - Select **Browse**, and then find and select the file you want to import using **Select > File to Open**. Click **OK** to close that dialog.

In either case, all variables in the MAT-file you selected are displayed in the **File Contents** list.

- 2** Select the variables to be imported into SPTool.

You can now import one or more variables from the **File Contents** list into SPTool, as long as these variables are scalars, vectors, or matrices.

## Saving and Loading Sessions

### In this section...

“SPTool Sessions” on page 8-37

“Filter Formats” on page 8-37

### SPTool Sessions

When you start SPTool, the default `startup.spt` session is loaded. To save your work in the startup SPTool session, use **File > Save Session** or to specify a session name, use **File > Save Session As**.

To recall a previously saved session, use **File > Open Session**.

### Filter Formats

When you start SPTool or open a session, the current filter design format preference is compared to the filter formats in the session. See “Setting Preferences” on page 8-43.

- If the formats match, the session opens.
- If the filter preference is FDATool, but the session contains Filter Designer filters, this warning displays:

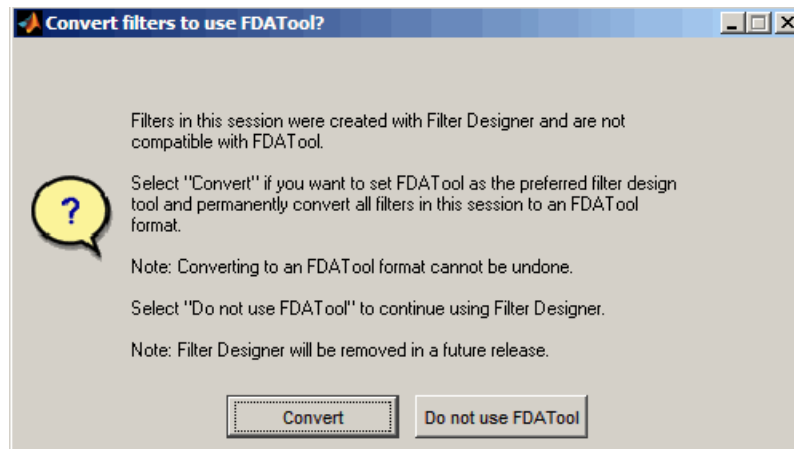

Click **Convert** to convert the filters to FDATool format. Click **Don't Use FDATool** to leave the filters in Filter Designer format and change the preference to **Use Filter Designer**.

- If the filter preference is **Use Filter Designer**, but the session contains FDATool filters, this warning displays:

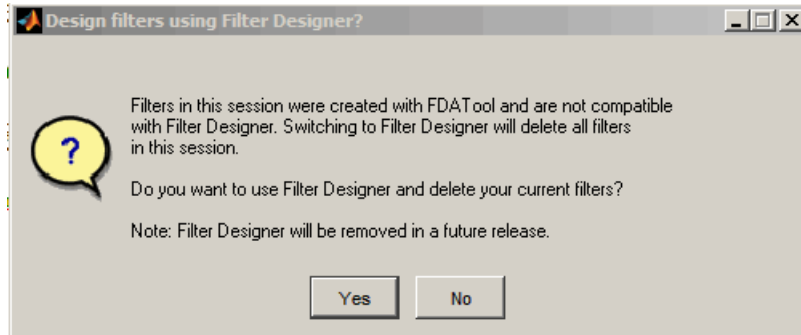

Click **Yes** to remove the current filters. Click **No** to leave the filters in FDATool.



## Selecting Signals, Filters, and Spectra

All signals, filters, or spectra listed in SPTool exist as special MATLAB structures. You can bring data representing signals, filters, or spectra into SPTool from the MATLAB workspace. In general, you can select one or several items in a given list box. An item is selected when it is highlighted.

The **Signals** list shows all vector and array signals in the current SPTool session.

The **Filters** list shows all designed and imported filters in the current SPTool session.

The **Spectra** list shows all spectra in the current SPTool session.

You can select a single data object in a list, a range of data objects in a list, or multiple separate data objects in a list. You can also have data objects simultaneously selected in different lists:

- To select a single item, click it. All other items in that list box become deselected.
- To add or remove a range of items, **Shift+click** on the items at the top and bottom of the section of the list that you want to add. You can also drag your mouse pointer to select these items.
- To add a single data object to a selection or remove a single data object from a multiple selection, **Ctrl+click** on the object.

## Editing Signals, Filters, or Spectra

You can edit selected items in SPTool by

- 1 Selecting the names of the signals, filters, or spectra you want to edit.
- 2 Selecting the appropriate **Edit** menu item:
  - **Duplicate** to copy an item in an SPTool list
  - **Clear** to delete an item in an SPTool list
  - **Name** to rename an item in an SPTool list
  - **Sampling Frequency** to modify the sampling frequency associated with either a signal (and its associated spectra) or filter in an SPTool list

The pull-down menu next to each menu item shows the names of all selected items.

You can also edit the following signal characteristics by right-clicking in the display region of the Signal Browser, the Filter Visualization Tool, or the Spectrum Viewer:

- The signal name
- The sampling frequency
- The line style properties

---

**Note** If you modify the sampling frequency associated with a signal's spectrum using the right-click menu on the Spectrum Viewer display region, the sampling frequency of the associated signal is automatically updated.

---







## Making Signal Measurements with Markers

You can use the markers on the Signal Browser or the Spectrum Viewer to make measurements on either of the following:

- A signal in the Signal Browser
- A power spectral density plotted in the Spectrum Viewer

The following marker buttons are included



Icon	Description
	Toggle markers on/off
	Vertical markers
	Horizontal markers
	Vertical markers with tracking
	Vertical markers with tracking and slope
	Display peaks (local maxima) You can find peaks in a signal from the command line with <code>findpeaks</code>
	Display valleys (local minima)

To make a measurement:

- 1 Select a line to measure (or play, if you are in the Signal Browser).
- 2 Select one of the marker buttons to apply a marker to the displayed signal.

**3** Position a marker in the main display area by grabbing it with your mouse and dragging:

**a** Select a marker setting. If you choose the **Vertical**, **Track**, or **Slope** buttons, you can drag a marker to the right or left. If you choose the **Horizontal** button, you can drag a marker up or down.

**b** Move the mouse over the marker (1 or 2) that you want to drag.

The hand cursor with the marker number inside it  is displayed when your mouse passes over a marker.

**c** Drag the marker to where you want it on the signal

As you drag a marker, the bottom of the Signal Browser shows the current position of both markers. Depending on which marker setting you select, some or all of the following fields are displayed — **x1**, **y1**, **x2**, **y2**, **dx**, **dy**, **m**. These fields are also displayed when you print from the Signal Browser, unless you suppress them.

You can also position a marker by typing its **x1** and **x2** or **y1** and **y2** values in the region at the bottom.

## Setting Preferences

In this section...
“Overview of Setting Preferences” on page 8-43
“Summary of Settable Preferences” on page 8-44
“Setting the Filter Design Tool” on page 8-45

### Overview of Setting Preferences

Use **File > Preferences** to customize displays and certain parameters for SPTool and its four component GUIs. If you change any preferences, a dialog box displays when you close SPTool asking if you want to save those changes. If you click **Yes**, the new settings are saved on disk and are used when you restart SPTool from the MATLAB workspace.

---

**Note** You can set MATLAB preferences that affect the Filter Visualization Tool only from within FVTool by selecting **File > Preferences**. You can set FVTool-specific preferences using **Analysis > Analysis Parameters**.

---

When you first select **Preferences**, the Preferences dialog box opens with **Markers** selected by default.

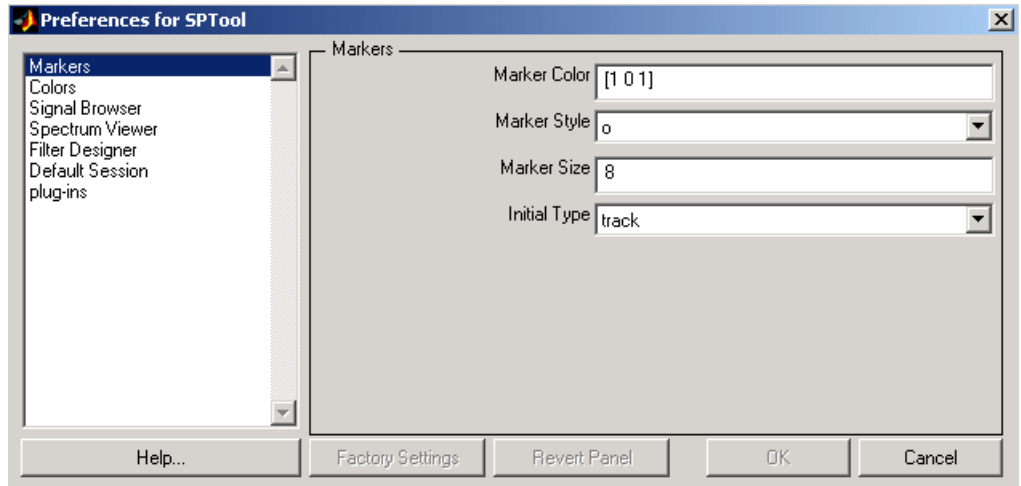

Change any marker settings, if desired. To change settings for another category, click its name in the category list to display its settings. Most of the fields are self-explanatory. Details of the Filter Design options are described below.

## Summary of Settable Preferences

In the Preferences regions, you can

- Select colors and markers for all displays.
- Select colors and line styles for displayed signals.
- Configure labels, and enable/disable markers, panner, and zoom in the Signal Browser.
- Configure display parameters, and enable/disable markers and zoom in the Spectrum Viewer.
- Select whether to use the default FDATool or the Filter Designer to design filters. FDATool is the recommended designer.
- Enable/disable use of a default session file.

- Export filters for use with Control System Toolbox software.
- Enable/disable search for plug-ins at startup.

## Setting the Filter Design Tool

The Filter Designer options include radio buttons to select the filter design tool.

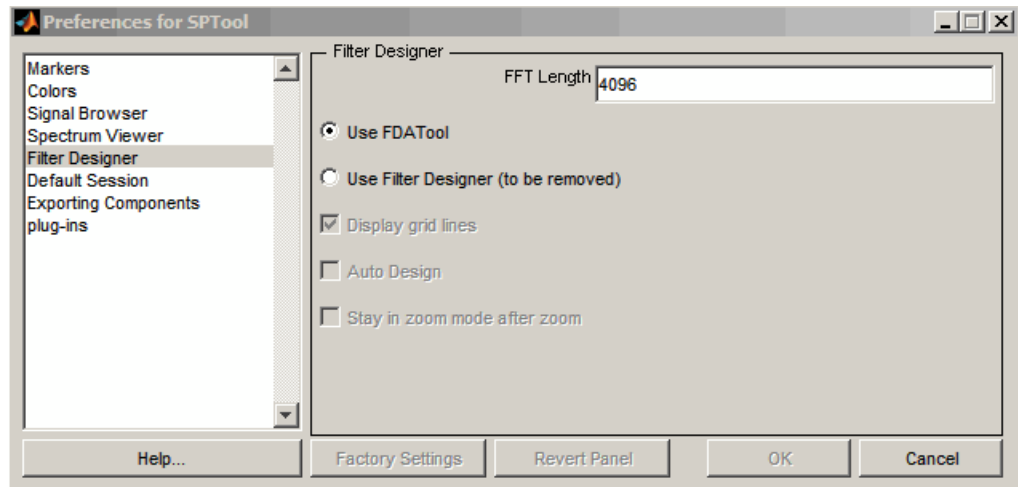

FDATool is the default and recommended tool. You can use Filter Designer, but Filter Designer will be removed in a future release. You cannot change this preference if either FDATool or the Filter Designer is open.

---

**Note** Filters in any one SPTool session must be in the same format — either FDATool format or Filter Designer format. You can convert filters from the Filter Designer format to FDATool format, but you cannot convert FDATool filters to Filter Designer format.

---

If you change the preference from **Use FDATool** to **Use Filter Designer**, a warning message appears. The warning message informs you that filters created with FDATool are not compatible with Filter Designer and that Filter Designer will be removed in the future.

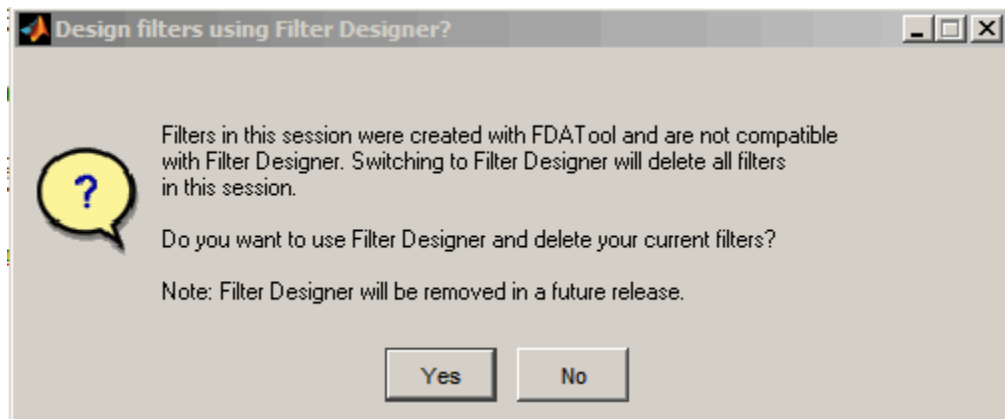

See “Saving and Loading Sessions” on page 8-37 for more information.

When you change the preference from **Use Filter Designer** to **Use FDATool**, a confirmation message appears indicating that switching will convert your filters to FDATool format. See “Saving and Loading Sessions” on page 8-37 for information on this message.

Changes to Filter Designer format are saved only if you save the session. Exiting the session prompts you to save changes to the `sigprefs.mat` and `startup.spt` files. Starting SPTool with Filter Designer specified as the filter design tool results in the warning:

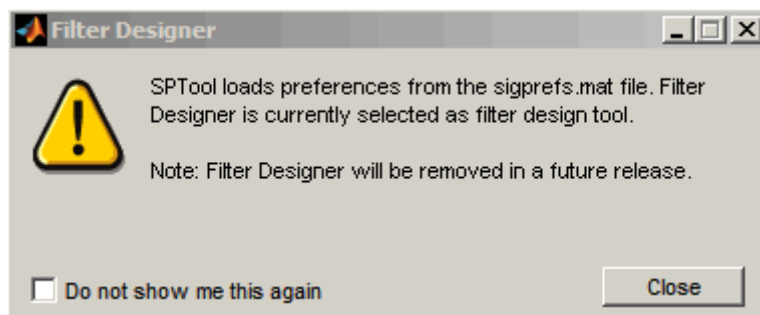

The warning appears each time SPTool initializes unless you opt to not show the warning.



## Using the Filter Designer

### In this section...

“Filter Designer” on page 8-47  
“Filter Types” on page 8-47  
“FIR Filter Methods” on page 8-48  
“IIR Filter Methods” on page 8-48  
“Pole/Zero Editor” on page 8-48  
“Spectral Overlay Feature” on page 8-48  
“Opening the Filter Designer” on page 8-48  
“Accessing Filter Parameters in a Saved Filter” on page 8-50  
“Designing a Filter with the Pole/Zero Editor” on page 8-53  
“Positioning Poles and Zeros” on page 8-54  
“Redesigning a Filter Using the Magnitude Plot” on page 8-56

### Filter Designer

“FDATool” on page 8-10 is the recommended filter design tool. Filter Designer will be removed in a future release. The following information is provided for users that choose to use Filter Designer while they transition to FDATool. Filter Designer, provides an interactive graphical environment for the design of digital IIR and FIR filters based on specifications that you enter on a magnitude or pole-zero plot.

### Filter Types

You can design filters of the following types using the Filter Designer:

- Bandpass
- Lowpass
- Bandstop
- Highpass

## **FIR Filter Methods**

You can use the following filter methods to design FIR filters:

- Equiripple
- Least squares
- Window

## **IIR Filter Methods**

You can use the following filter methods to design IIR filters:

- Butterworth
- Chebyshev Type I
- Chebyshev Type II
- Elliptic

## **Pole/Zero Editor**

You can use the Pole/Zero Editor to design arbitrary FIR and IIR filters by placing and moving poles and zeros on the complex  $z$ -plane.

## **Spectral Overlay Feature**

You can also superimpose spectra on a filter's magnitude response to see if the filtering requirements are met.

## **Opening the Filter Designer**



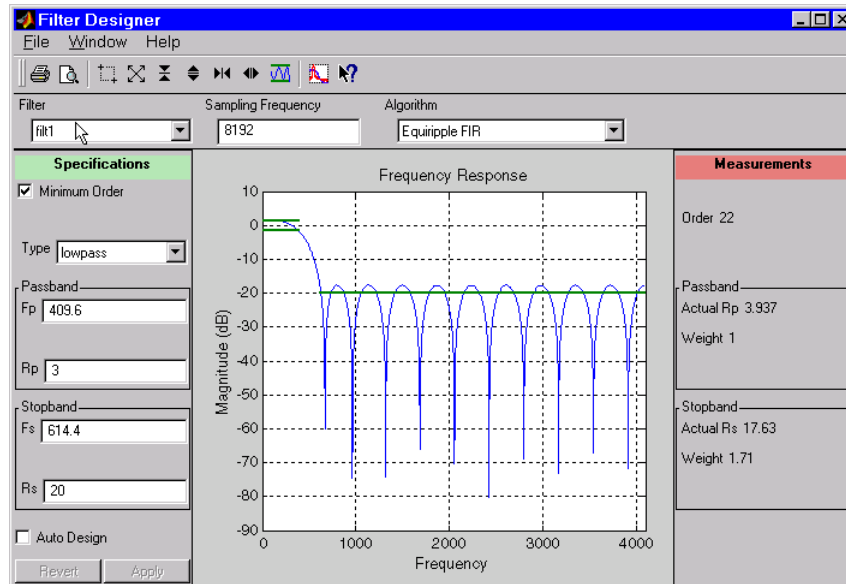

Open the Filter Designer from SPTool by either:

- Clicking **New** in the **Filters** list in SPTool
- Selecting a filter you want to edit from the **Filters** list in SPTool, and then clicking **Edit**



The Filter Designer has the following components:

- A pull-down **Filter** menu for selecting a filter from the list in SPTool
- A **Sampling Frequency** text box
- A pull-down **Algorithm** menu for selecting a filter design method or a pole-zero plot display
- A Specifications area for viewing or modifying a filter's design parameters or pole-zero locations
- A plot display region for graphically adjusting filter magnitude responses or the pole-zero locations
- A Measurements area for viewing the response characteristics and stability of the current filter
- A toolbar with the following buttons

Icon	Description
	Print and print preview
	Zoom in and out
	Passband view
	Overlay spectrum
	Turn on the What's This help

## Accessing Filter Parameters in a Saved Filter

The MATLAB structures created by SPTool have several associated fields, many of which are also MATLAB structures. See the MATLAB documentation for general information about MATLAB structures.

For example, after exporting a filter `filt1` to the MATLAB workspace, type

```
filt1
```

to display the fields of the MATLAB filter structure. The `tf`, `Fs`, and `specs` fields of the structure contain the information that describes the filter.

### The `tf` Field: Accessing Filter Coefficients

The `tf` field is a structure containing the transfer function representation of the filter. Use this field to obtain the filter coefficients;

- `filt1.tf.num` contains the numerator coefficients.
- `filt1.tf.den` contains the denominator coefficients.

The vectors contained in these structures represent polynomials in descending powers of  $z$ . The numerator and denominator polynomials are used to specify the transfer function

$$H(z) = \frac{B(z)}{A(z)} = \frac{b(1) + b(2)z^{-1} + \dots + b(nb+1)z^{-m}}{a(1) + a(2)z^{-1} + \dots + a(na+1)z^{-n}}$$

where:

- $b$  is a vector containing the coefficients from the `tf.num` field.
- $a$  is a vector containing the coefficients from the `tf.den` field.
- $m$  is the numerator order.
- $n$  is the denominator order.

You can change the filter representation from the default transfer function to another form by using the `tf2ss` or `tf2zp` functions.

### The Fs Field: Accessing Filter Sample Frequency

The `Fs` field contains the sampling frequency of the filter in hertz.

### The specs Field: Accessing other Filter Parameters

The `specs` field is a structure containing parameters that you specified for the filter design. The first field, `specs.currentModule`, contains a string representing the most recent design method selected from the Filter Designer's **Algorithm** list before you exported the filter. The possible contents of the `currentModule` field and the corresponding design methods are shown below.

Contents of the <code>currentModule</code> field	Design Method
<code>fdbutter</code>	Butterworth IIR
<code>fdcheby1</code>	Chebyshev Type I IIR
<code>fdcheby2</code>	Chebyshev Type II IIR
<code>fdellip</code>	Elliptic IIR
<code>fdfirls</code>	Least Squares FIR
<code>fdkaiser</code>	Kaiser Window FIR
<code>fdremez</code>	Equiripple FIR

Following the `specs.currentModule` field, there may be up to seven additional fields, with labels such as `specs.fdremez`, `specs.fdfirls`, etc. The design specifications for the most recently exported filter are contained in the field whose label matches the `currentModule` string. For example, if the `specs` structure is

```
filt1.specs
ans
  currentModule: 'fdremez'
  fdremez: [1x1 struct]
```

the filter specifications are contained in the `fdremez` field, which is itself a data structure.

The specifications include the parameter values from the Specifications region of the Filter Designer, such as band edges and filter order. For example, the filter above has the following specifications stored in `filt1.specs.fdremez`:

```
filt1.specs.fdremez
ans =
  setOrderFlag: 0
  type: 3
  f: [0 0.2000 0.3000 0.5000 0.6000 1]
  m: [6x1 double]
  Rp: 0.0100
  Rs: 75
  wt: [3.2371 1 3.2371]
  order: 78
```

Because certain filter parameters are unique to a particular design, this structure has a different set of fields for each filter design.

The table below describes the possible fields associated with the filter design specification field (the `specs` field) that can appear in the exported structure.

Parameter	Description
Beta	Kaiser window $\beta$ parameter.
f	Contains a vector of band-edge frequencies, normalized so that 1 Hz corresponds to half the sample frequency.
Fpass	Passband cutoff frequencies. Scalar for lowpass and highpass designs, two-element vector for bandpass and bandstop designs.
Fstop	Stopband cutoff frequencies. Scalar for lowpass and highpass designs, two-element vector for bandpass and bandstop designs.
m	The response magnitudes corresponding to the band-edge frequencies in f.
order	Filter order.
Rp	Passband ripple (dB)
Rs	Stopband attenuation (dB)
setOrderFlag	Contains 1 if the filter order was specified manually (i.e., the <b>Minimum Order</b> box in the Specifications region was not selected). Contains 0 if the filter order was computed automatically.
type	Contains 1 for lowpass, 2 for highpass, 3 for bandpass, or 4 for bandstop.
w3db	-3 dB frequency for Butterworth IIR designs.
wind	Vector of Kaiser window coefficients.
Wn	Cutoff frequency for the Kaiser window FIR filter when setOrderFlag = 1.
wt	Vector of weights, one weight per frequency band.

## Designing a Filter with the Pole/Zero Editor

To design a filter transfer function using the Filter Designer Pole/Zero Editor:

- 1 Select the Pole/Zero Editor option from the **Algorithm** list to open the Pole/Zero Editor in the Filter Designer display.



- 2 Enter the desired filter gain in the **Gain** edit box.
- 3 Select a pole or zero (or conjugate pair) by selecting one of the **x** (pole) or **o** (zero) symbols on the plot.
- 4 Choose the coordinates to work in by specifying **Polar** or **Rectangular** from the **Coordinates** list.
- 5 Specify the new location(s) of the selected pole, zero, or conjugate pair by typing values into the **Mag** and **Angle** fields (for angular coordinates) or **X** and **Y** (for rectangular coordinates) fields. Alternatively, position the poles and zeros by dragging the **x** and **o** symbols.
- 6 Use the **Conjugate pair** check box to create a conjugate pair from a lone pole or zero, or to break a conjugate pair into two individual poles or zeros.

Design a new filter or edit an existing filter in the same way.



---

**Note** Keep the Filter Visualization Tool (FVTool) open while designing a filter with the Pole/Zero Editor. Any changes that you make to the filter transfer function in the Pole/Zero Editor are then simultaneously reflected in the response plots of FVTool.



---

## Positioning Poles and Zeros

You can use your mouse to move poles and zeros around the pole/zero plot and modify your filter design.

Icon	Description
	Enable moving poles or zeros by dragging on the plot
	Add pole



Icon	Description
	Add zero
	Erase poles or zeros

You can move both members of a conjugate pair simultaneously by manipulating just one of the poles or zeros.

To ungroup conjugates, select the desired pair and clear **Conjugate pair** in the Specifications region on the Filter Designer.

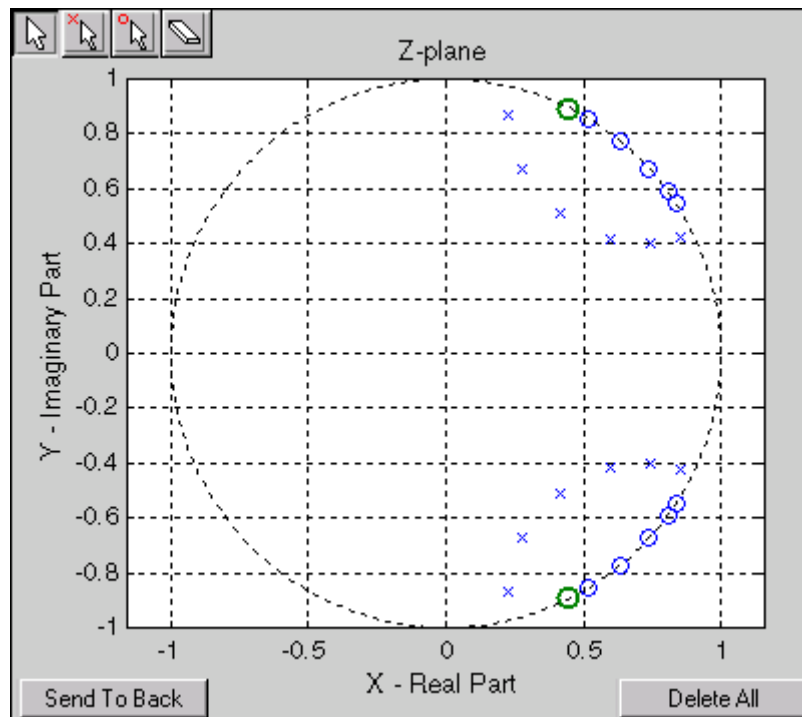

When you place two or more poles (or two or more zeros) directly on top of each other, a number is displayed next to the symbols (on the left for poles, and on the right for zeros) indicating the number of poles or zeros at that location (e.g.,  for three zeros). This number makes it easy to keep track of all the

poles and zeros in the plot area, even when several are superimposed on each other and are not visually differentiable. Note, however, that this number *does not* indicate the *multiplicity* of the poles or zeros to which it is attached.

To detect whether or not a set of poles or zeros are truly multiples, use the zoom tools to magnify the region around the poles or zeros in question. Because numerical limitations usually prevent any set of poles or zeros from sharing *exactly* the same value, at a high enough zoom level even truly multiple poles or zeros appear distinct from each other.

A common way to assess whether a particular group of poles or zeros contains multiples is by comparing the mutual proximity of the group members against a selected threshold value. As an example, the `residuez` function defines a pole or zero as being a multiple of another pole or zero if the absolute distance separating them is less than 0.1% of the larger pole or zero's magnitude.

## Redesigning a Filter Using the Magnitude Plot

After designing a filter in the Filter Designer, you can redesign it by dragging the specification lines on the magnitude plot. Use the specification lines to change passband ripple, stopband attenuation, and edge frequencies.

In the following example, create a Chebyshev filter and modify it by dragging the specification lines:

- 1** Select Chebyshev Type I IIR from the **Algorithm** menu.
- 2** Select highpass from the **Type** menu.
- 3** Type 2000 in the **Sampling Frequency** field.
- 4** Set the following parameters:
  - **F<sub>p</sub>** = 800
  - **F<sub>s</sub>** = 700
  - **R<sub>p</sub>** = 2.5
  - **R<sub>s</sub>** = 35
- 5** Select **Minimum Order** so the Filter Designer can calculate the lowest filter order that produces the desired characteristics.

- 6** Click **Apply** to compute the filter and update the response plot.
- 7** Position the cursor over the horizontal filter specification line for the stopband. This is the first (leftmost) horizontal specification line you see.

The cursor changes to the up/down drag indicator.

- 8** Drag the line until the **Rs** (stopband attenuation) field reads 100.

---

**Note** The **Order** value in the Measurements region changes because a higher filter order is needed to meet the new specifications.

---



# Code Generation from MATLAB Support in Signal Processing Toolbox

---

- “Supported Functions” on page 9-2
- “Specifying Inputs in Code Generation from MATLAB ” on page 9-7
- “Code Generation Examples” on page 9-11

## Supported Functions

Code generation from MATLAB is a restricted subset of the MATLAB language that provides optimizations for:

- Generating efficient, production-quality C/C++ code and MEX files for deployment in desktop and embedded applications. For embedded targets, the subset restricts MATLAB semantics to meet the memory and data type requirements of the target environments.

Depending on which feature you wish to use, there are additional required products. For a comprehensive list, see “Installing Prerequisite Products” in the Embedded Coder® documentation.

Code generation from MATLAB supports Signal Processing Toolbox functions listed in the table. You must have the DSP System Toolbox software installed to use this feature. To generate C code, you must have the MATLAB Coder™ software. If you have the Fixed-Point Toolbox, you can use `fiaccel` to generate MEX code for fixed-point applications.

To follow the examples in this documentation:

- To generate C/C++ code and MEX files with `codegen`, install the MATLAB Coder software, the Signal Processing Toolbox, the DSP System Toolbox, and a C compiler. For the Windows® platform, MATLAB supplies a default C compiler. Run `mex -setup` at the MATLAB command prompt to set up the C compiler.
- Change to a folder where you have write permission.

---

**Note** Many Signal Processing Toolbox functions require constant inputs in generated code. To specify a constant input for `codegen`, use `coder.Constant`.

---

<b>Function</b>	<b>Remarks/Limitations</b>
barthannwin	Window length must be a constant. Expressions or variables are allowed if their values do not change.
bartlett	Window length must be a constant. Expressions or variables are allowed if their values do not change.
besselap	Filter order must be a constant. Expressions or variables are allowed if their values do not change.
bitrevorder	—
blackman	Window length must be a constant. Expressions or variables are allowed if their values do not change.
blackmanharris	Window length must be a constant. Expressions or variables are allowed if their values do not change.
bohmanwin	Window length must be a constant. Expressions or variables are allowed if their values do not change.
buttap	Filter order must be a constant. Expressions or variables are allowed if their values do not change.
butter	Filter coefficients must be constants. Expressions or variables are allowed if their values do not change.
buttord	All inputs must be constants. Expressions or variables are allowed if their values do not change.
cfirpm	All inputs must be constants. Expressions or variables are allowed if their values do not change.
cheb1ap	All inputs must be constants. Expressions or variables are allowed if their values do not change.
cheb2ap	All inputs must be constants. Expressions or variables are allowed if their values do not change.
cheb1ord	All inputs must be constants. Expressions or variables are allowed if their values do not change.
cheb2ord	All inputs must be constants. Expressions or variables are allowed if their values do not change.
chebwin	All inputs must be constants. Expressions or variables are allowed if their values do not change.

Function	Remarks/Limitations
cheby1	All Inputs must be constants. Expressions or variables are allowed if their values do not change.
cheby2	All inputs must be constants. Expressions or variables are allowed if their values do not change.
dct	Length of transform dimension must be a power of two. If specified, the pad or truncation value must be constant. Expressions or variables are allowed if their values do not change.
downsample	—
dpss	All inputs must be constants. Expressions or variables are allowed if their values do not change.
ellip	Inputs must be constant. Expressions or variables are allowed if their values do not change.
ellipap	All inputs must be constants. Expressions or variables are allowed if their values do not change.
ellipord	All inputs must be constants. Expressions or variables are allowed if their values do not change.
filtfilt	Filter coefficients must be constants. Expressions or variables are allowed if their values do not change.
fir1	All inputs must be constants. Expressions or variables are allowed if their values do not change.
fir2	All inputs must be constants. Expressions or variables are allowed if their values do not change.
fircls	All inputs must be constants. Expressions or variables are allowed if their values do not change.
fircls1	All inputs must be constants. Expressions or variables are allowed if their values do not change.
firls	All inputs must be constants. Expressions or variables are allowed if their values do not change.
firpm	All inputs must be constants. Expressions or variables are allowed if their values do not change.



<b>Function</b>	<b>Remarks/Limitations</b>
firpmord	All inputs must be constants. Expressions or variables are allowed if their values do not change.
firrcos	All inputs must be constants. Expressions or variables are allowed if their values do not change.
flattopwin	All inputs must be constants. Expressions or variables are allowed if their values do not change.
freqz	freqz with no output arguments produces a plot only when the function call terminates in a semicolon. See “freqz With No Output Arguments” on page 9-15.
gaussfir	All inputs must be constant. Expressions or variables are allowed if their values do not change.
gausswin	All inputs must be constant. Expressions or variables are allowed if their values do not change.
hamming	All inputs must be constant. Expressions or variables are allowed if their values do not change.
hann	All inputs must be constant. Expressions or variables are allowed if their values do not change.
idct	Length of transform dimension must be a power of two. If specified, the pad or truncation value must be constant. Expressions or variables are allowed if their values do not change.
intfilt	All inputs must be constant. Expressions or variables are allowed if their values do not change.
kaiser	All inputs must be constant. Expressions or variables are allowed if their values do not change.
kaiserord	—
levinson	If specified, the order of recursion must be a constant. Expressions or variables are allowed if their values do not change.
maxflat	All inputs must be constant. Expressions or variables are allowed if their values do not change.
nutallwin	All inputs must be constant. Expressions or variables are allowed if their values do not change.

Function	Remarks/Limitations
parzenwin	All inputs must be constant. Expressions or variables are allowed if their values do not change.
rectwin	All inputs must be constant. Expressions or variables are allowed if their values do not change.
resample	The upsampling and downsampling factors must be specified as constants. Expressions or variables are allowed if their values do not change.
sgolay	All inputs must be constant. Expressions or variables are allowed if their values do not change.
sosfilt	—
taylorwin	All inputs must be constant. Expressions or variables are allowed if their values do not change.
triang	All inputs must be constant. Expressions or variables are allowed if their values do not change.
tukeywin	All inputs must be constant. Expressions or variables are allowed if their values do not change.
upfirdn	<ul style="list-style-type: none"> <li>• Filter coefficients, upsampling factor, and downsampling factor must be constants. Expressions or variables are allowed if their values do not change.</li> <li>• Variable-size inputs are not supported.</li> </ul>
upsample	Either declare input <code>n</code> as constant, or use the <code>assert</code> function in the calling function to set upper bounds for <code>n</code> . For example,  <code>assert(n&lt;10)</code>
xcorr	—
yulewalk	If specified, the order of recursion must be a constant. Expressions or variables are allowed if their values do not change.

## Specifying Inputs in Code Generation from MATLAB

### In this section...

“Defining Input Size and Type” on page 9-7

“Inputs must be Constants” on page 9-8

### Defining Input Size and Type

When you use Signal Processing Toolbox functions for code generation, you must define the size and type of the function inputs. One way to do this is with the `-args` compilation option. The size and type of inputs must be defined because C is a statically typed language. . To illustrate the need to define input size and type, consider the simplest call to `xcorr` requiring two input arguments. The following demonstrates the differences in the use of `xcorr` in MATLAB and in Code Generation from MATLAB.

Cross correlate two white noise vectors in MATLAB:

```
x = randn(512,1); %real valued white noise
y = randn(512,1); %real valued white noise
[C,lags] = xcorr(x,y);
x_circ = randn(256,1)+1j*randn(256,1); %circular white noise
y_circ = randn(256,1)+1j*randn(256,1); %circular white noise
[C1,lags1] = xcorr(x_circ,y_circ);
```

`xcorr` does not require any information about the size and type of the input arguments. `xcorr` obtains this information at runtime. Contrast this behavior with a MEX-file created with `codegen`. Create the file `myxcorr.m` in a folder where you have read and write permission. Ensure that this folder is in the MATLAB search path. Copy and paste the following two lines of code into `myxcorr.m` and save the file. The compiler tag `%#codegen` must be included in the file.

```
function [C,Lags]=myxcorr(x,y) %#codegen
[C,Lags]=xcorr(x,y);
```

Enter the following command at the MATLAB command prompt:

```
codegen myxcorr -args {zeros(512,1),zeros(512,1)} -o myxcorr
```

Run the MEX-file:

```
x = randn(512,1); %real valued white noise
y = randn(512,1); %real valued white noise
[C,Lags] = myxcorr(x,y);
```

Define two new inputs x1 and y1 by transposing x and y.

```
x1 = x'; %x1 is 1x512
y1 = y'; %y1 is 1x512
```

Attempt to rerun the MEX-file with the transposed inputs.

```
[C,Lags] = myxcorr(x1,y1); %Errors
```

The preceding program errors with the message ??? MATLAB expression 'x' is not of the correct size: expected [512x1] found [1x512]..

The error results because the inputs are specified to be 512x1 real-valued column vectors at compilation. For complex-valued inputs, you must specify that the input is complex valued. For example:

```
codegen myxcorr -o ComplexXcorr ...
-args {complex(zeros(512,1)),complex(zeros(512,1))}
```

Run the MEX-file at the MATLAB command prompt with complex-valued inputs of the correct size:

```
x_circ = randn(512,1)+1j*randn(512,1); %circular white noise
y_circ = randn(512,1)+1j*randn(512,1); %circular white noise
[C,Lags] = ComplexXcorr(x_circ,y_circ);
```

Attempting to run ComplexXcorr with real valued inputs results in the error: ??? MATLAB expression 'x' is not of the correct complexness.

## Inputs must be Constants

For a number of supported Signal Processing Toolbox functions, the inputs or a subset of the inputs must be specified as constants at compilation time. Functions with this behavior are noted in the right column of the table “Supported Functions” on page 9-2. Use `coder.Type` with the `-args` compilation option, or enter the constants directly in the source code.

Specifying inputs as constants at compilation time results in significant advantages in the speed and efficiency of the generated code. For example, storing filter coefficients or window function values as vectors in the C source code improves performance by avoiding costly computation at runtime. Because a primary purpose of Code Generation from MATLAB is to generate optimized C code for desktop and embedded systems, emphasis is placed on providing the user with computational savings at runtime whenever possible.

To illustrate the constant input requirement with `butter`, create the file `myLowpassFilter.m` in a folder where you have read and write permission. Ensure that this folder is in the MATLAB search path. Copy and paste the following lines of code into `myLowpassFilter.m` and save the file.

```
function output = myLowpassFilter(input,N,Wn) %#codegen
[B,A] = butter(N,Wn,'low');
output = filter(B,A,input);
```

If you have the MATLAB Coder software, enter the following command at the MATLAB command prompt:

```
codegen myLowpassFilter -o myLowpassFilter ...
-args {zeros(512,1), coder.newtype('constant',5),coder.newtype('constant',0)}
```

Once the program compiles successfully, the following message appears in the command window: Code generation successful: [View report](#).

Click on [View report](#). Click on the C code tab on the top left and open the target source file `myLowpassFilter.c`.

Note that the numerator and denominator filter coefficients are included in the source code.

```
static real_T dv0[6] = { 5.9795780369978346E-5, 0.00029897890184989173,
static real_T dv1[6] = { 1.0, -3.9845431196123373, 6.4348670902758709, ..
```

Run the MEX-file without entering the constants:

```
output = myLowpassFilter(randn(512,1));
```

If you attempt to run the MEX-file by inputting the constants, you receive the error ??? Error using ==> myLowpassFilter 1 input required for entry-point 'myLowpassFilter'..

You may also enter the constants in the MATLAB source code directly. Edit the `myLowpassFilter.m` file and replace the MATLAB code with the lines:

```
function output = myLowpassFilter(input) %#codegen
[B,A] = butter(5,0.1,'low');
output = filter(B,A,input);
```

Enter the following command at the MATLAB command prompt:

```
codegen myLowpassFilter -args {zeros(512,1)} -o myLowpassFilter
```

Run the MEX-file by entering the following at the MATLAB command prompt:

```
output = myLowpassFilter(randn(512,1));
```

See “Apply Window to Input Signal” on page 9-11, “Apply Lowpass Filter to Input Signal” on page 9-13, and “Zero Phase Filtering” on page 9-16 for additional examples of the constant input requirement.

## Code Generation Examples

### In this section...

“Apply Window to Input Signal” on page 9-11

“Apply Lowpass Filter to Input Signal” on page 9-13

“Cross Correlate or Autocorrelate Input Data” on page 9-14

“freqz With No Output Arguments” on page 9-15

“Zero Phase Filtering” on page 9-16

### Apply Window to Input Signal

In this example, apply a Hamming window to an input data vector of size 512x1.

Create a file called `window_data.m` by typing

```
>>edit window_data
```

at the MATLAB command prompt.

Copy and paste the code provided into the editor and save the file.

```
function output_data=window_data(input_data,N) %#codegen
Win=hamming(N);
output_data=input_data.*Win;
```

Use `codegen` to generate a MEX-file `window_data.m`.

```
codegen window_data -args {zeros(512,1),coder.newtype('constant',512)} -o w
```

The `-args` option defines the input specifications for the MEX-file. `input_data` is a 512x1 real valued vector. Because the input to `hamming` must be a constant, `coder.newtype` is used to specify the window length. In a conventional MATLAB program, you can read the input data length at runtime and construct a Hamming window of the corresponding length.

Alternatively, edit the code for `window_data.m` as follows:

```
function output_data=window_data(input_data) %#codegen
Win=hamming(512);
output_data=input_data.*Win;
```

The preceding code specifies the length of the Hamming window in the source code as opposed to using `coder.newtype`. Use `codegen` to generate a MEX-file and C code:

```
codegen window_data -args {zeros(512,1)} -o window_data -report
```

The `-report` flag generates a compilation report. If the `codegen` operation is successful, you obtain: Code generation successful: View report.

Click on `View report` to view the Code Generation Report.

Select the C-code tab and select `window_data.c` as the Target Source File.

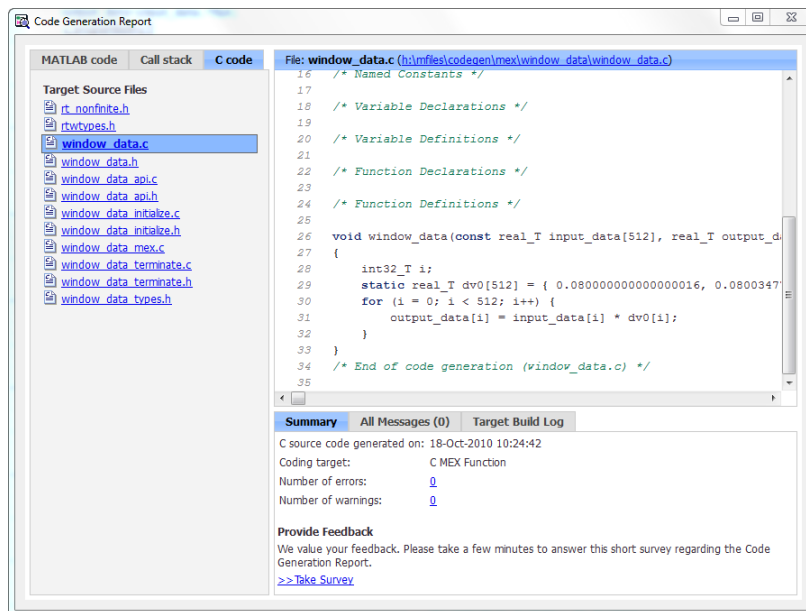

Note from the location bar that the C source code is in the `codegen/mex/<FUNCTION_NAME>` folder. Running `codegen` creates this folder



and places the C source code, C header files, and MEX files in the folder. Each function that you create produces a `codegen/mex/<FUNCTION_NAME>` folder.

Scroll through the C code to see that the values of the Hamming window are included directly in the C source code.

Run the MEX-file on a white noise input:

```
% Window white noise input
output_data=window_data(randn(512,1));
```

## Apply Lowpass Filter to Input Signal

Assuming a sampling frequency of 20 kHz, create a 4–th order Butterworth filter with a 3–dB frequency of 2.5 kHz. Use the Butterworth filter to lowpass filter a 10000x1 input data vector.

Create a file called `ButterFilt.m`. Copy and paste the following code into the file.

```
function output_data=ButterFilt(input_data) %#codegen
[b,a]=butter(4,0.25);
output_data=filter(b,a,input_data);
```

Run the `codegen` command to obtain the C source code `ButterFilt.c` and MEX file:

```
codegen ButterFilt -args {zeros(10000,1)} -o ButterFilt -report
```

The C source code includes the five numerator and denominator coefficients of the 4–th order Butterworth filter as constants.

```
static real_T dv0[5] = { 0.010209480791203124, 0.040837923164812495, 0.0612
static real_T dv1[5] = { 1.0, -1.9684277869385174, 1.7358607092088851, -0.7
```

Apply the filter using the MEX-file:

```
Fs=20000;
%Create 10000x1 input signal
t=0:(1/Fs):0.5-(1/Fs);
input_data=(cos(2*pi*100*t)+sin(2*pi*500*t)+0.2*randn(size(t)))';
%Filter data
```

```
output_data=ButterFilt(input_data);
```

## Cross Correlate or Autocorrelate Input Data

Estimate the cross correlation or autocorrelation of two real-valued input vectors to lag 50. Output the estimate at the nonnegative lags.

Create a file called `myxcorr.m`. Copy and paste the following code into the file:

```
function [C,Lags]=myxcorr(x,y) %#codegen
[c,lags]=xcorr(x,y,50,'coeff');
C=c(51:end);
Lags=lags(51:end);
```

Run the `codegen` command at the MATLAB command prompt:

```
codegen myxcorr -args {zeros(512,1), zeros(512,1)} -o myxcorr -report
```

Use the MEX-file to compute and plot the autocorrelation of a white noise input:

```
rng(0,'twister')
%White noise input
input_data=randn(512,1);
%Compute autocorrelation with MEX-file
[C,Lags]=myxcorr(input_data,input_data);
% Plot the result
stem(Lags,C); axis([-0.5 51 -1.1 1.1])
xlabel('Lags'); ylabel('Autocorrelation Function');
```

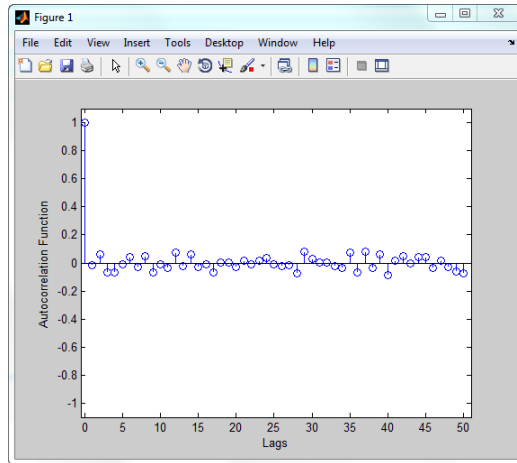

## freqz With No Output Arguments

In Code Generation from MATLAB, `freqz` with no output arguments behaves differently than in the standard MATLAB language. In standard MATLAB, `freqz` with no output arguments produces a plot of the magnitude and phase response of the input filter. The plot is produced regardless of whether the call to `freqz` terminates in a semicolon or not. No frequency response or phase vectors are returned.

`freqz` with no output arguments and no terminating semicolon:

```
B = [0.05 0.9 0.05]; %Numerator coefficients
freqz(B,1) %no semicolon. Plot is produced
```

`freqz` with no output arguments and terminating in a semicolon:

```
B = [0.05 0.9 0.05]; %Numerator coefficients
freqz(B,1); %semicolon. Plot is produced
```

The behavior shown in the preceding examples differs from the expected behavior of a MEX-file using `freqz` with code generation support. To illustrate this difference create a program called `myfreqz.m`.

Copy and paste the following code into the file:

```
function myfreqz(B,A) %#codegen
freqz(B,A)
```

Run the following command at the MATLAB command prompt:

```
codegen myfreqz -args {zeros(1,3), zeros(1,1)} -o myfreqz
```

Calling the MEX-file writes a 512x1 complex-valued vector to the workspace and displays the output. The vector is the frequency response. No plot is produced.

```
myfreqz([0.05 0.9 0.05],1);
```

Change the code in `myfreqz.m` by adding a terminating semicolon:

```
function myfreqz(B,A) %#codegen
freqz(B,A);
```

Run the following command at the MATLAB command prompt:

```
codegen myfreqz -args {zeros(1,3), zeros(1,1)} -o myfreqz
```

Calling the MEX-file produces a plot of the magnitude and phase response of the filter. The output of the complex-valued frequency response is suppressed.

```
myfreqz([0.05 0.9 0.05],1);
```

## Zero Phase Filtering

Design a lowpass Butterworth filter with a 1 kHz 3-dB frequency to implement zero phase filtering on data with a sampling frequency of 20 kHz.

```
[B,A] = butter(20,0.314,'low');
```

Create the program `myZerophaseFilt.m`.

```
function output = myZerophaseFilt(input) %#codegen
B=1e-3 * [
    0.0000
    0.0001
    0.0010
    0.0060
```

```
0.0254
0.0814
0.2035
0.4071
0.6615
0.8820
0.9702
0.8820
0.6615
0.4071
0.2035
0.0814
0.0254
0.0060
0.0010
0.0001
0.0000];
A=[1.0000
-7.4340
28.2476
-71.6333
134.6222
-197.9575
235.1628
-230.2286
188.0901
-129.1746
74.8284
-36.5623
15.0197
-5.1525
1.4599
-0.3361
0.0613
-0.0085
0.0009
-0.0001
0.0000];
output = filtfilt(B,A,input);
```

Run the following command at the MATLAB command prompt:

```
codegen myZerophaseFilt -args {zeros(1,20001)} -o myZerophaseFilt
```

Filter input data with myZerophaseFilt:

```
Fs = 20000;  
t = 0:(1/Fs):1;  
Comp500Hz = cos(2*pi*500*t);  
Signal = Comp500Hz+sin(2*pi*4000*t)+0.2*randn(size(t));  
FilteredData = myZerophaseFilt(Signal);  
plot(t(1:500).*1000,Comp500Hz(1:500));  
xlabel('msec'); ylabel('Amplitude');  
axis([0 25 -1.8 1.8]); hold on;  
plot(t(1:500).*1000,FilteredData(1:500),'r','linewidth',2);  
legend('500 Hz component','Zero phase lowpass filtered data',...  
'Location','NorthWest');
```

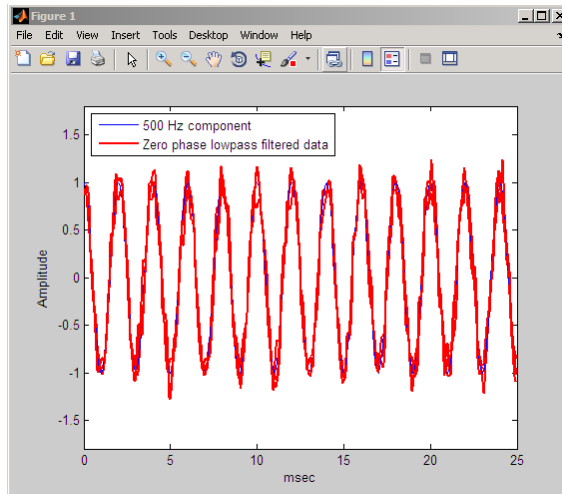

# Convolution and Correlation

---

- “Linear and Circular Convolution” on page 10-2
- “Confidence Intervals for Sample Autocorrelation” on page 10-5
- “Residual Analysis with Autocorrelation” on page 10-9
- “Autocorrelation of Moving Average Process” on page 10-19
- “Cross-correlation of Two Moving Average Processes” on page 10-21
- “Cross-correlation of Delayed Signal in Noise” on page 10-23
- “Cross-correlation of Phase-Lagged Sine Wave” on page 10-26

## Linear and Circular Convolution

This example shows how to establish an equivalence between linear and circular convolution.

Linear and circular convolution are fundamentally different operations. However, there are conditions under which linear and circular convolution are equivalent. Establishing this equivalence has important implications. For two vectors,  $x$  and  $y$ , the circular convolution is equal to the inverse discrete Fourier transform (DFT) of the product of the vectors' DFTs. Knowing the conditions under which linear and circular convolution are equivalent allows you to use the DFT to efficiently compute linear convolutions.

The linear convolution of an  $N$ -point vector,  $x$ , and a  $L$ -point vector,  $y$ , has length  $N+L-1$ .

For the circular convolution of  $x$  and  $y$  to be equivalent, you must pad the vectors with zeros to length at least  $N+L-1$  before you take the DFT. After you invert the product of the DFTs, retain only the first  $N+L-1$  elements.

Create two vectors,  $x$  and  $y$ , and compute the linear convolution of the two vectors.

```
x = [2 1 2 1];  
y = [1 2 3];  
clin = conv(x,y);
```

The output has length  $4+3-1$ .

Pad both vectors with zeros to length  $4+3-1$ . Obtain the DFT of both vectors, multiply the DFTs, and obtain the inverse DFT of the product.

```
xpad = [x zeros(1,6-length(x))];  
ypad = [y zeros(1,6-length(y))];  
ccirc = ifft(fft(xpad).*fft(ypad));
```

The circular convolution of the zero-padded vectors,  $xpad$  and  $ypad$ , is equivalent to the linear convolution of  $x$  and  $y$ . You retain all the elements of  $ccirc$  because the output has length  $4+3-1$ .



Plot the output of linear convolution and the inverse of the DFT product to show the equivalence.

```
subplot(211)
stem(cclin,'markerfacecolor',[0 0 1]);
title('Linear Convolution of x and y');
set(gca,'ylim',[0 11]);
subplot(212)
stem(ccirc,'markerfacecolor',[0 0 1]);
set(gca,'ylim',[0 11]);
title('Circular Convolution of xpad and ypad');
```

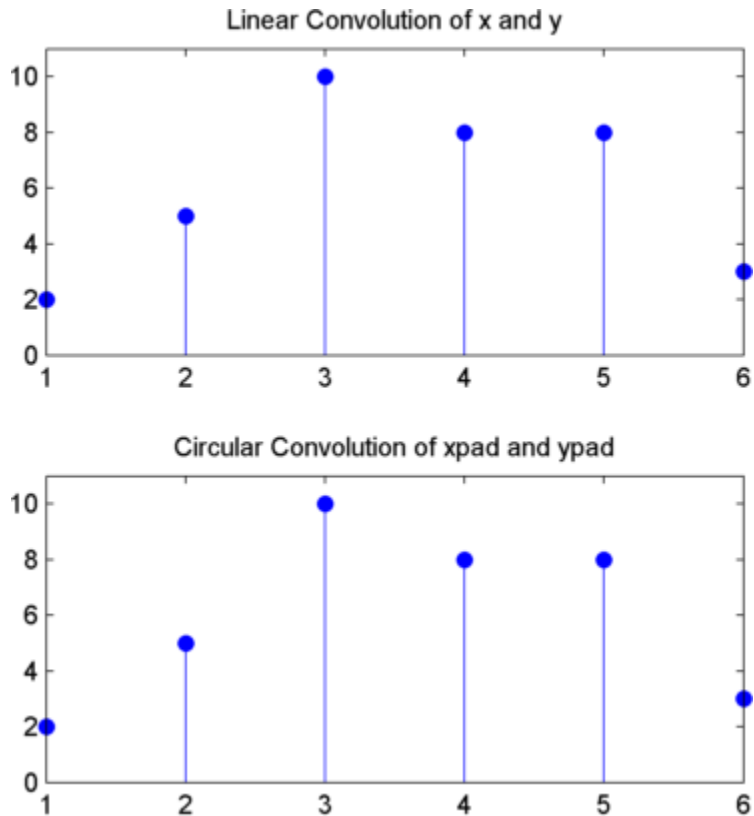

Pad the vectors to length 12 and obtain the circular convolution using the inverse DFT of the product of the DFTs. Retain only the first  $4+3-1$  elements to produce an equivalent result to linear convolution.

```
N = length(x)+length(y)-1;
xpad = [x zeros(1,12-length(x))];
ypad = [y zeros(1,12-length(y))];
ccirc = ifft(fft(xpad).*fft(ypad));
ccirc = ccirc(1:N);
```

The Signal Processing Toolbox software has a function, `cconv`, that returns the circular convolution of two vectors. You can obtain the linear convolution of `x` and `y` using circular convolution with the following code.

```
ccirc2 = cconv(x,y,6);
```

`cconv` internally uses the same DFT-based procedure illustrated in the previous example.

## Confidence Intervals for Sample Autocorrelation

This example shows how to construct confidence intervals for the sample autocorrelation of a white noise process. Having confidence intervals for a white noise process is important, because many time series procedures aim to *whiten*, or decorrelate a random process. To determine the effectiveness of the whitening procedure, you examine the autocorrelation.

If  $x(n)$  is a white noise process, the sample normalized autocorrelation is approximately normally distributed with mean zero and variance  $1/N$ , where  $N$  is the length of the input vector. In other words, the sample normalized autocorrelation values follow a  $N(0, 1/N)$  distribution.

You can form an approximate confidence interval using the mean plus or minus the appropriate  $\alpha$ -level critical value on the standard normal distribution times the standard deviation. For a symmetric distribution like the Gaussian (normal), this interval takes the form

$$\mu \pm z_{\alpha/2}\sigma$$

where  $\mu$  is the mean,  $\sigma$  is the standard deviation, and  $z_{\alpha/2}$  is the value such that the interval contains  $(1-\alpha)\%$  of the probability.

For the  $N(0,1)$  distribution,  $z_{\alpha/2} = 1.96$  gives a 95% probability interval.

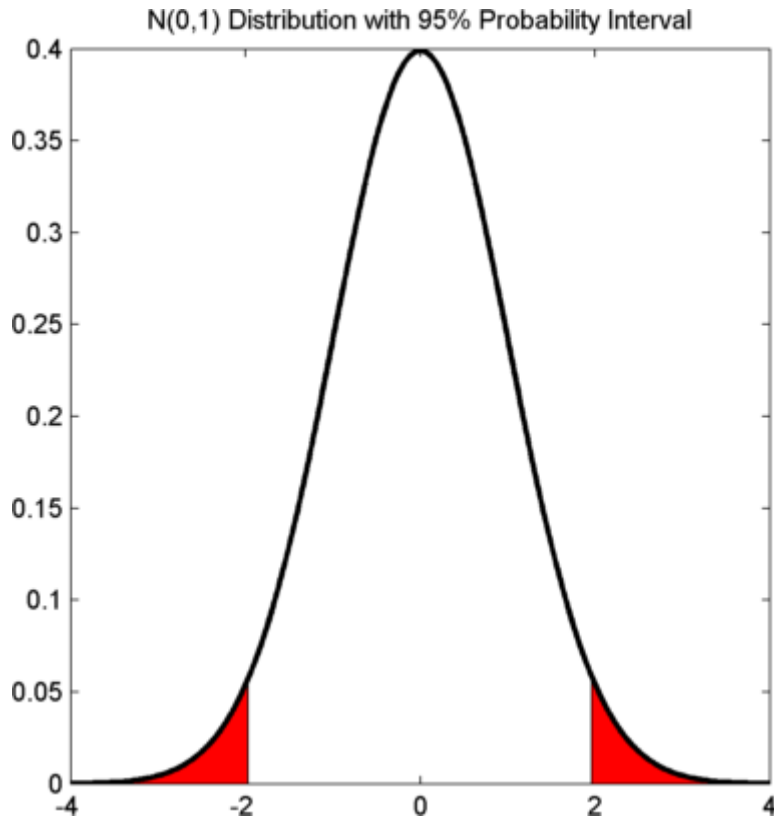

Create a realization of a white noise process 1,000 samples in length. Compute the sample autocorrelation to lag 20. Plot the sample autocorrelation along with the approximate 95%-confidence intervals for a white noise process.

Create the white noise random vector. Set the random number generator to the default settings for reproducible results. Obtain the normalized sampled autocorrelation to lag 20.

```
rng default;  
x = randn(1e3,1);  
[xc,lags] = xcorr(x,20,'coeff');
```

Create the lower and upper 95% confidence bounds for the  $N(0,1/N)$  distribution. For a 95%-confidence interval, the critical value is 1.96. The

standard deviation is the square root of  $1/N$ , where  $N$  is the length of the input vector.

The confidence interval is

$$0 \pm \frac{1.96}{\sqrt{1000}}$$

```
lconf = -1.96/sqrt(length(x));  
upconf = 1.96/sqrt(length(x));
```

Plot the sample autocorrelation along with the 95%-confidence interval.

```
stem(lags,xc,'markerfacecolor',[0 0 1]);  
set(gca,'ylim',[lconf-0.03 1.05]);  
hold on;  
line(lags,lconf*ones(size(lags)),'color','r','linewidth',2);  
line(lags,upconf*ones(size(lags)),'color','r','linewidth',2);  
title('Sample Autocorrelation with 95% Confidence Intervals');
```

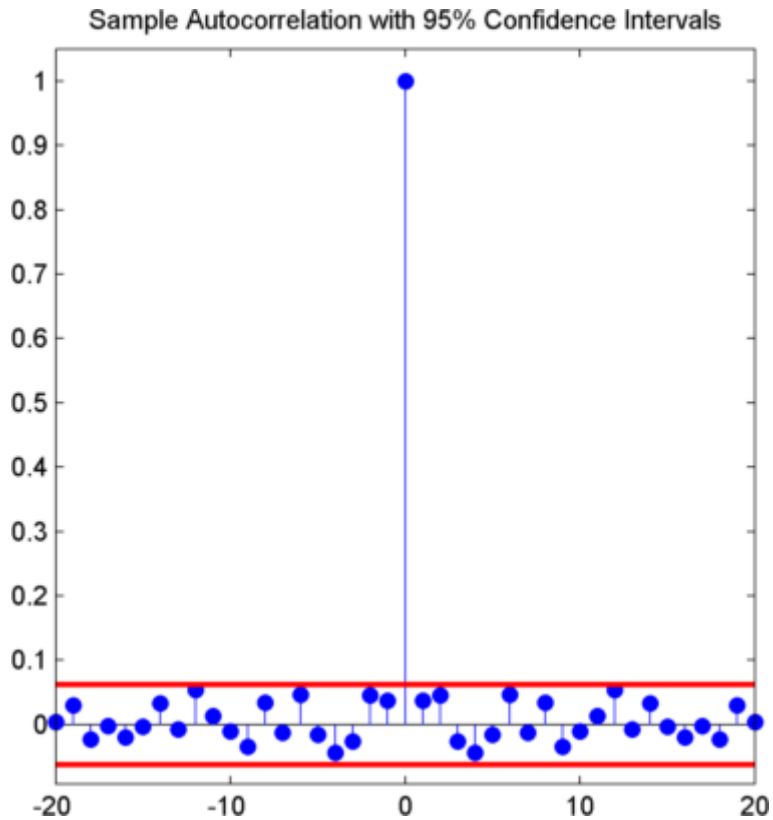

You see in the above figure that the only autocorrelation value outside of the 95%-confidence interval occurs at lag 0 as expected for a white noise process. Based on this result, you can conclude that the data are a realization of a white noise process.

## Residual Analysis with Autocorrelation

This example shows you how to use autocorrelation with a confidence interval to analyze the residuals of a least-squares fit to noisy data. The residuals are the differences between the fitted model and the data. In a signal+white noise model, if you have a good fit for the signal, the residuals should be white noise. The example “Confidence Intervals for Sample Autocorrelation” on page 10-5 demonstrates the basic technique for forming a confidence interval for the sample autocorrelation. This example extends the technique illustrated in that example.

Create a noisy data set consisting of a 1st order polynomial (straight line) in additive white Gaussian noise. The additive noise is a sequence of uncorrelated random variables following a  $N(0,1)$  distribution. This means that all the random variables have mean zero and unit variance. Set the random number generator to the default settings for reproducible results.

```
x = -3:0.01:3;
rng default
y = 2*x+randn(size(x));
plot(x,y)
```

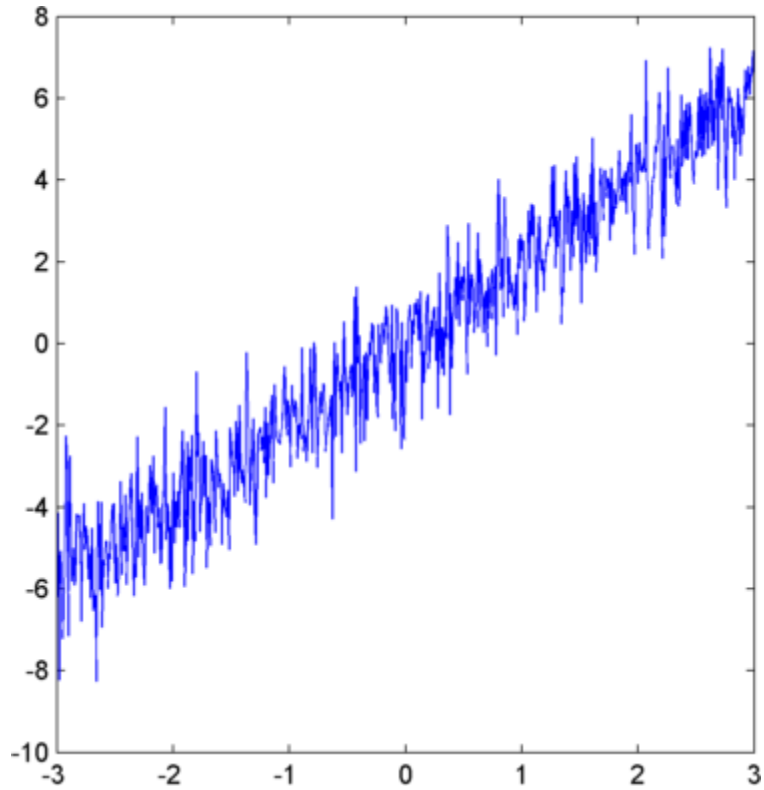

Use `polyfit` to find the least-squares line for the noisy data. Plot the original data along with the least-squares fit.

```
coeffs = polyfit(x,y,1);  
yfit = coeffs(2)+coeffs(1)*x;  
plot(x,y); hold on;  
plot(x,yfit,'r','linewidth',2)
```



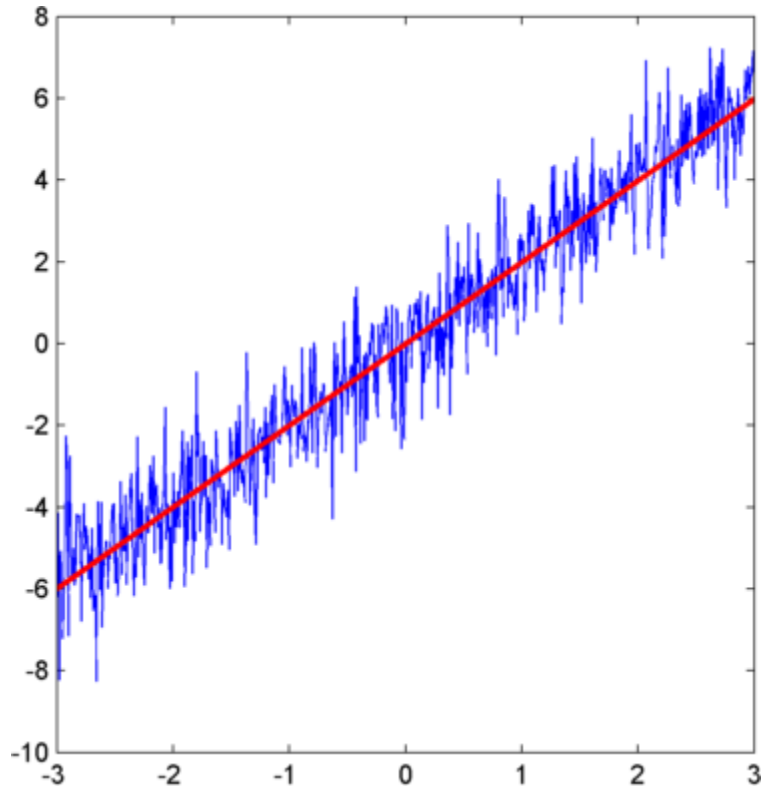

Find the residuals. Obtain the autocorrelation sequence of the residuals to lag 50.

```
residuals = y-yfit;  
[xc,lags] = xcorr(residuals,50,'coeff');
```

When you inspect the autocorrelation sequence, you want to determine whether or not there is evidence of autocorrelation. In other words, you want to determine whether the sample autocorrelation sequence looks like the autocorrelation sequence of white noise. If the autocorrelation sequence of the residuals looks like the autocorrelation of a white noise process, you are confident that none of the signal has escaped your fit and ended up in the residuals. In this example, use a 99%-confidence interval. To construct the confidence interval, you need to know the distribution of the sample autocorrelation values. This is described in “Confidence Intervals for Sample

Autocorrelation” on page 10-5. You also need to find the critical values on the appropriate distribution between which lie 0.99 of the probability. Because the distribution in this case is Gaussian, you can use complementary inverse error function, `erfcinv`. The relationship between this function and the inverse of the Gaussian cumulative distribution function is described on the reference page for `erfcinv`.

Find the critical value for the 99%-confidence interval.

```
conf99 = sqrt(2)*erfcinv(2*.01/2)
```

Use the critical value to construct the lower and upper confidence bounds.

```
lconf = -conf99/sqrt(length(x));  
upconf = conf99/sqrt(length(x));
```

Plot the autocorrelation sequence along with the 99%-confidence intervals.

```
stem(lags,xc,'markerfacecolor',[0 0 1]);  
set(gca,'ylim',[lconf-0.03 1.05]);  
hold on;  
line(lags,lconf*ones(size(lags)),'color','r','linewidth',2);  
line(lags,upconf*ones(size(lags)),'color','r','linewidth',2);  
title('Sample Autocorrelation with 99% Confidence Intervals');
```

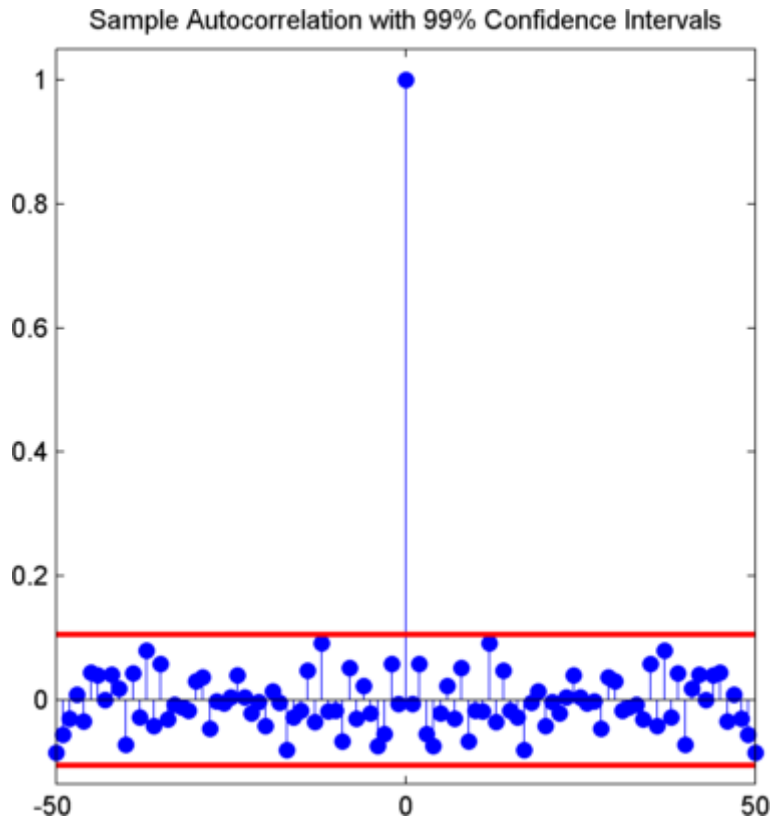

Except at zero lag, the sample autocorrelation values lie within the 99%-confidence bounds for the autocorrelation of a white noise sequence. From this, you can conclude that the residuals are white noise. More specifically, you cannot reject that the residuals are a realization of a white noise process.

Create a signal consisting of a sine wave plus noise. The data are sampled at 1 kHz. The frequency of the sine wave is 100 Hz. Set the random number generator to the default settings for reproducible results.

```
Fs = 1000;
t = 0:1/Fs:1-1/Fs;
rng default
x = cos(2*pi*100*t)+randn(size(t));
```

Use the discrete Fourier transform (DFT) to obtain the least-squares fit to the sine wave at 100 Hz. The least-squares estimate of the amplitude is  $2/N$  times the DFT coefficient corresponding to 100 Hz, where  $N$  is the length of the signal. The real part is the amplitude of a cosine at 100 Hz and the imaginary part is the amplitude of a sine at 100 Hz. The least-squares fit is the sum of the cosine and sine with the correct amplitude. In this example, DFT bin 101 corresponds to 100 Hz.

```
xdfit = fft(x);  
ampest = 2/length(x)*xdfit(101);  
xfit = real(ampest)*cos(2*pi*100*t)+imag(ampest)*sin(2*pi*100*t);  
plot(t,x,'r-.','linewidth',2); hold on;  
plot(t,xfit,'b','linewidth',2);  
axis([0 0.30 -4 4]);  
xlabel('Seconds'); ylabel('Amplitude');
```

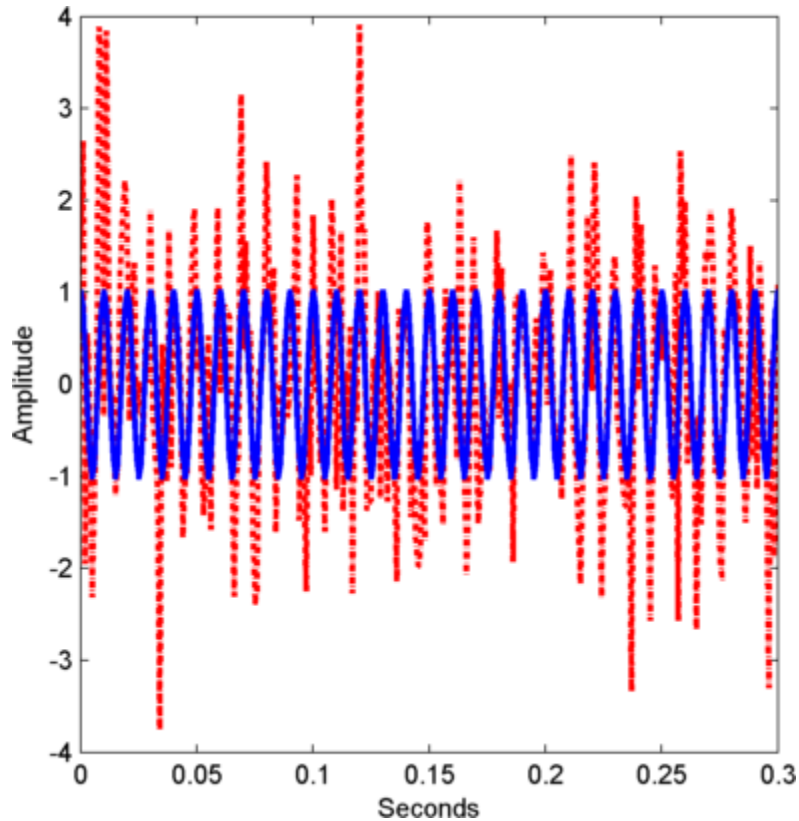

Find the residuals and determine the sample autocorrelation sequence to lag 50.

```
residuals = x-xfit;
[xc,lags] = xcorr(residuals,50,'coeff');
```

Plot the autocorrelation sequence with the 99%-confidence intervals.

```
stem(lags,xc,'markerfacecolor',[0 0 1]);
set(gca,'ylim',[lconf-0.03 1.05]);
hold on;
line(lags,lconf*ones(size(lags)),'color','r','linewidth',2);
line(lags,upconf*ones(size(lags)),'color','r','linewidth',2);
title('Sample Autocorrelation with 99% Confidence Intervals');
```

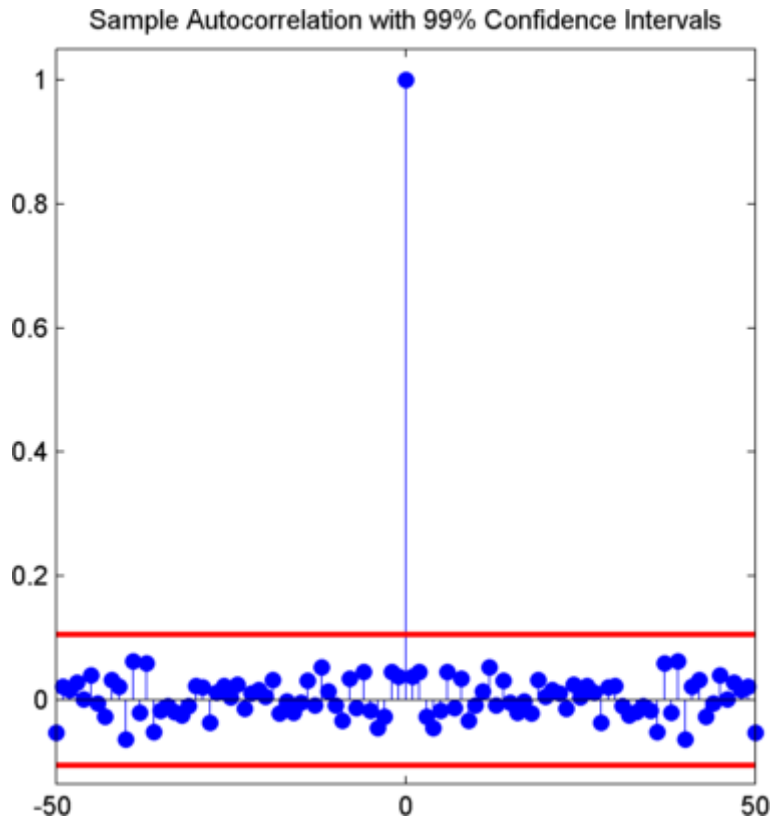

Again, you see that except at zero lag, the sample autocorrelation values lie within the 99%-confidence bounds for the autocorrelation of a white noise sequence. From this, you can conclude that the residuals are white noise. More specifically, you cannot reject that the residuals are a realization of a white noise process.

Finally, add another sine wave with a frequency of 200 Hz and an amplitude of  $3/4$ . Fit only the sine wave at 100 Hz and find the sample autocorrelation of the residuals.

```
x = x+3/4*sin(2*pi*200*t);
xdft = fft(x);
ampest = 2/length(x)*xdft(101);
xfit = real(ampest)*cos(2*pi*100*t)+imag(ampest)*sin(2*pi*100*t);
```

```
residuals = x-xfit;
[xc,lags] = xcorr(residuals,50,'coeff');
```

Plot the sample autocorrelation along with the 99%-confidence intervals.

```
stem(lags,xc,'markerfacecolor',[0 0 1]);
set(gca,'ylim',[lconf-0.12 1.05]);
hold on;
line(lags,lconf*ones(size(lags)),'color','r','linewidth',2);
line(lags,upconf*ones(size(lags)),'color','r','linewidth',2);
title('Sample Autocorrelation with 99% Confidence Intervals');
```

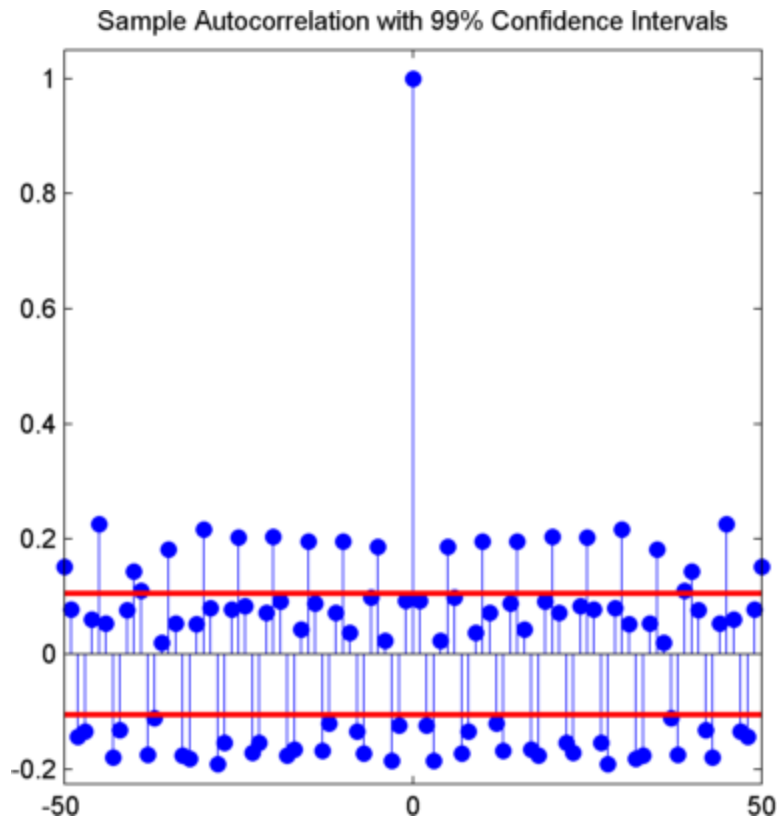

In this case, the autocorrelation values clearly exceed the 99%-confidence bounds for a white noise autocorrelation at many lags. Here you can reject the

hypothesis that the residuals are a white noise sequence. The implication is that the model has not accounted for all the signal and therefore the residuals consist of signal+noise.



## Autocorrelation of Moving Average Process

This example shows how filtering a white noise process introduces autocorrelation. The example also shows how the sample autocorrelation sequence does not agree perfectly with the known theoretical autocorrelation sequence. However, the sample autocorrelation sequence accurately represents the general form of the theoretical autocorrelation.

Simulate a realization of an  $N(0,1)$  white noise process. Filter the process with a 3-point moving average (MA) filter. Plot the sample autocorrelation along with the known theoretical autocorrelation for comparison.

Create the impulse response for the 3-point MA filter. Filter an  $N(0,1)$  white noise with the filter. Set the random number generator to the default settings for reproducible results.

```
h = 1/3*ones(3,1);
rng default;
x = randn(100,1);
y = filter(h,1,x);
```

Obtain the biased sample autocorrelation out to 20 lags. Plot the sample autocorrelation along with the theoretical autocorrelation.

```
[xc,lags] = xcorr(y,20,'biased');
stem(lags,xc,'markerfacecolor',[0 0 1]);
Xc = zeros(size(xc));
Xc([19 23]) = 1/9*var(x);
Xc([20 22]) = 2/9*var(x);
Xc(21) = 3/9*var(x);
hold on;
stem(lags,Xc,'color',[1 0 0],'marker','none','linewidth',2);
legend('Sample Autocorrelation','Theoretical Autocorrelation',...
       'Location','NorthEast');
```

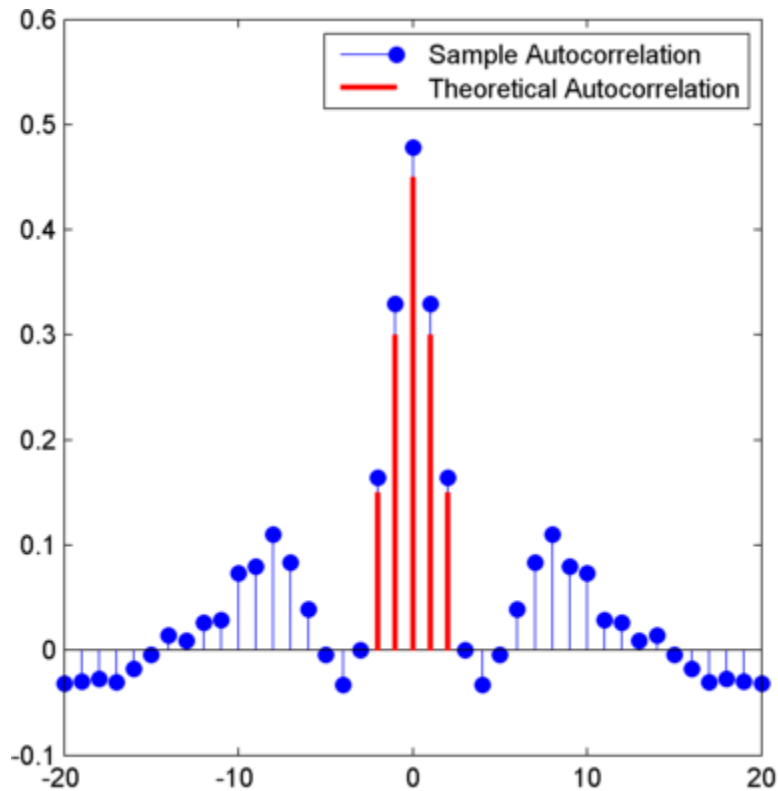

The theoretical autocorrelation is zero outside of lags  $[-2, 2]$ , while the sample autocorrelation is not. However, the magnitudes (absolute values) of the sample autocorrelation decay quickly to zero outside of lags  $[-2, 2]$ .

The sample autocorrelation sequence is not in perfect agreement with the theoretical autocorrelation, but captures that the filter has introduced significant autocorrelation only over lags  $[-2, 2]$ .

## Cross-correlation of Two Moving Average Processes

This example shows how to find and plot the cross-correlation sequence between two moving average processes. The example compares the sample cross-correlation with the theoretical cross-correlation.

Filter an  $N(0,1)$  white noise input with two different moving average filters. Plot the sample and theoretical cross-correlation sequences.

Create an  $N(0,1)$  white noise sequence. Set the random number generator to the default settings for reproducible results. Create two moving average filters. One filter has impulse response  $\delta(n)+\delta(n-1)$ . The other filter has impulse response,  $\delta(n)-\delta(n-1)$ .

```
rng default;
w = randn(100,1);
x = filter([1 1],1,w);
y = filter([1 -1],1,w);
```

Obtain the sample cross-correlation sequence up to lag 20. Plot the sample cross-correlation along with the theoretical cross-correlation.

```
[xc,lags] = xcorr(x,y,20,'biased');
stem(lags,xc,'markerfacecolor',[0 0 1]);
Xc = zeros(size(xc));
Xc(20) = -1;
Xc(22) = 1;
hold on;
stem(lags,Xc,'color',[1 0 0],'marker','none','linewidth',2);
legend('Sample Cross-correlation','Theoretical Cross-correlation',...
       'Location','NorthWest')
```

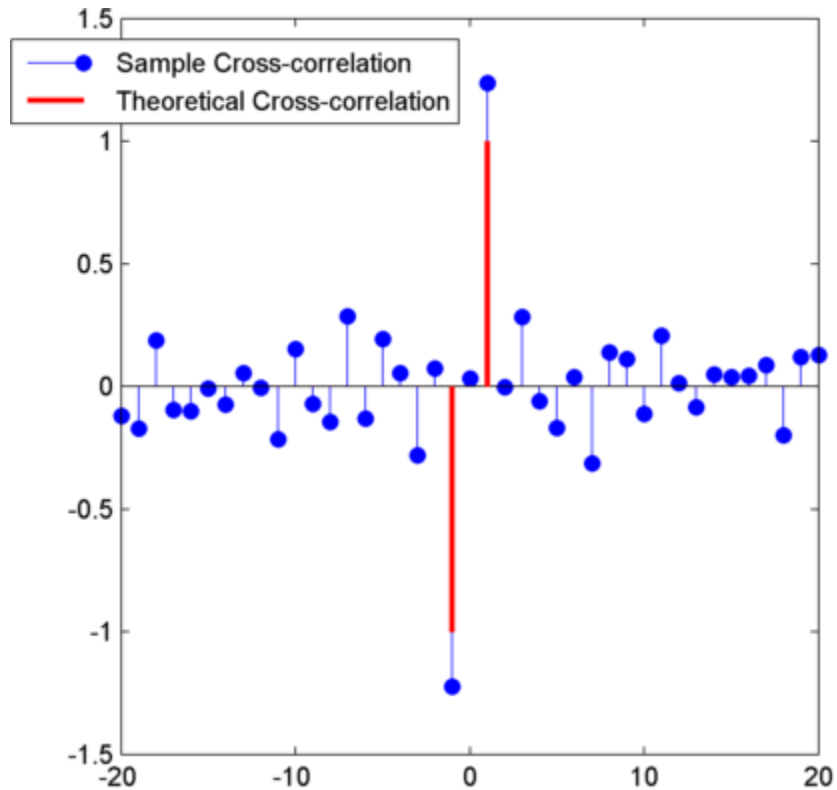

The theoretical cross-correlation is -1 at lag -1, 1 at lag 1, and zero at all other lags. The sample cross-correlation sequence approximates the theoretical cross-correlation.

As expected, there is not perfect agreement between the theoretical cross-correlation and sample cross-correlation. The sample cross-correlation does accurately represent both the sign and magnitude of the theoretical cross-correlation sequence values at lag -1 and lag 1.

## Cross-correlation of Delayed Signal in Noise

This example shows how to use the cross-correlation sequence to detect the time delay in a noise-corrupted sequence. The output sequence is a delayed version of the input sequence with additive white Gaussian noise.

Create two sequences. One sequence is a delayed version of the other. The delay is 3 samples. Add an  $N(0,0.3^2)$  white noise sequence to the delayed signal. Use the sample cross-correlation sequence to detect the lag.

Create and plot the signals. Set the random number generator to the default settings for reproducible results.

```
rng default;  
x = triang(20);  
y = [zeros(3,1); x]+0.3*randn(length(x)+3,1);  
subplot(211)  
stem(x, 'markerfacecolor',[0 0 1]); axis([0 22 -1 2]);  
subplot(212)  
stem(y, 'markerfacecolor',[0 0 1]); axis([0 22 -1 2]);
```

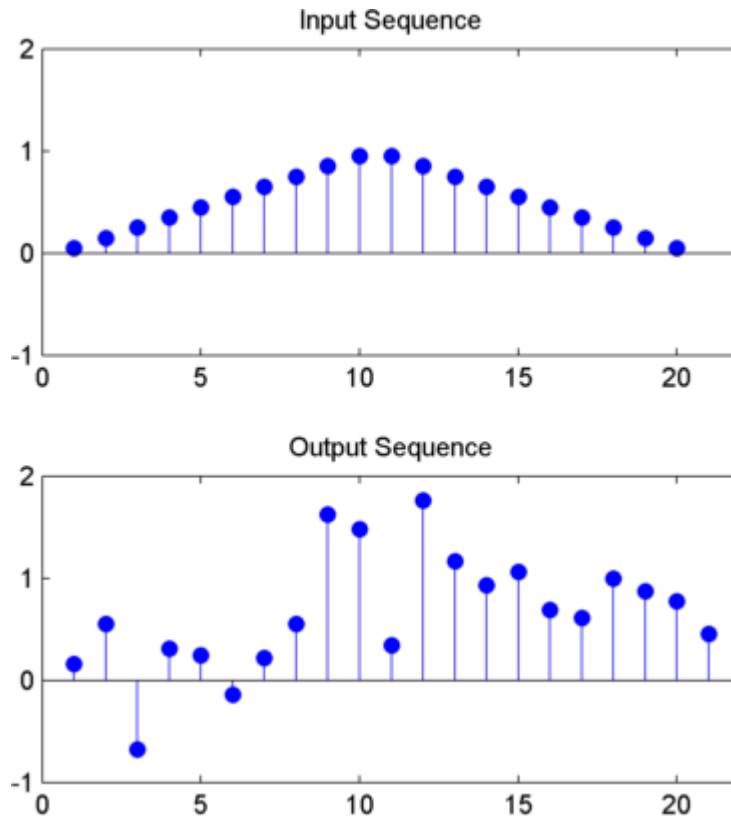

Obtain the sample cross-correlation sequence and use the maximum absolute value to estimate the lag. Plot the sample cross-correlation sequence.

```
[xc,lags] = xcorr(y,x);
[~,I] = max(abs(xc));
fprintf('Maximum cross correlation sequence value occurs at lag %d\n',lags(I));
figure;
stem(lags,xc,'markerfacecolor',[0 0 1]);
```

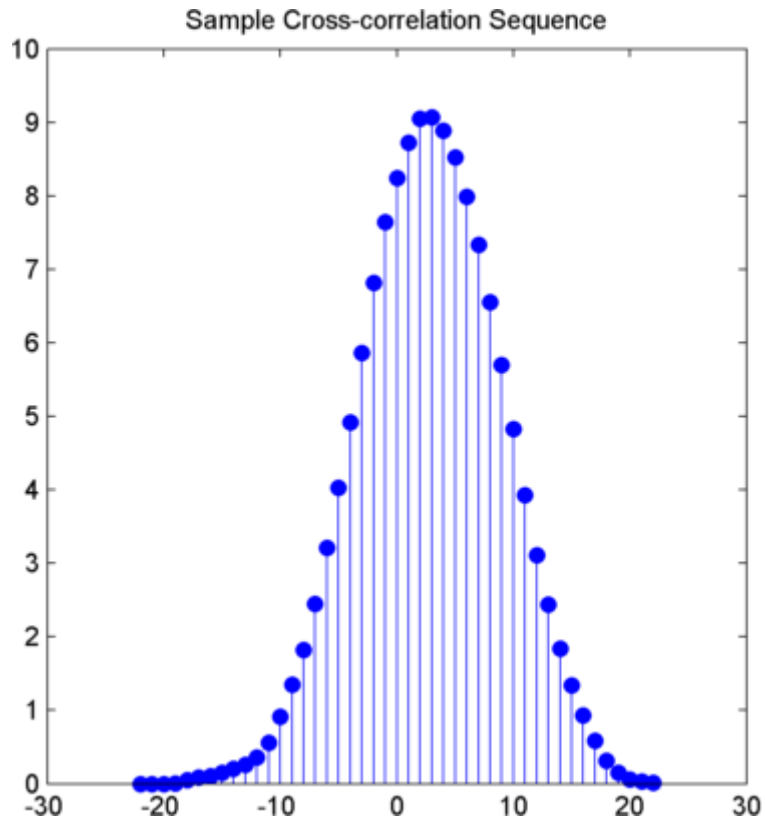

The maximum cross correlation sequence value occurs at lag 3 as expected.

## Cross-correlation of Phase-Lagged Sine Wave

This example shows how to use the cross-correlation sequence to estimate the phase lag between two sine waves. The theoretical cross-correlation sequence of two sine waves at the same frequency also oscillates at that frequency. Because the sample cross-correlation sequence uses fewer and fewer samples at larger lags, the sample cross-correlation sequence also oscillates at the same frequency, but the amplitude decays as the lag increases.

Use the cross-correlation sequence to detect the phase lag between two sine waves with a frequency of  $2\pi/10$  radians/sample. One sine wave lags the other in phase by  $\pi$  radians.

Create two sine waves with frequencies of  $2\pi/10$  radians/sample. The starting phase of one sine wave is 0, while the starting phase of the other sine wave is  $-\pi$  radians. Add  $N(0,0.25^2)$  white noise to the sine wave with the phase lag of  $\pi$  radians. Set the random number generator to the default settings for reproducible results.

```
t = 0:99;
rng default;
x = cos(2*pi*1/10*t);
y = cos(2*pi*1/10*t-pi)+0.25*randn(size(t));
```

Obtain the sample cross-correlation sequence for two periods of the sine wave (10 samples). Plot the cross-correlation sequence and mark the known lag between the two sine waves (5 samples).

```
[xc,lags] = xcorr(y,x,20,'coeff');
stem(lags(21:end),xc(21:end),'markerfacecolor',[0 0 1]);
set(gca,'xtick',0:5:20);
hold on;
plot([5 5],[-1 1],'r','linewidth',2);
```



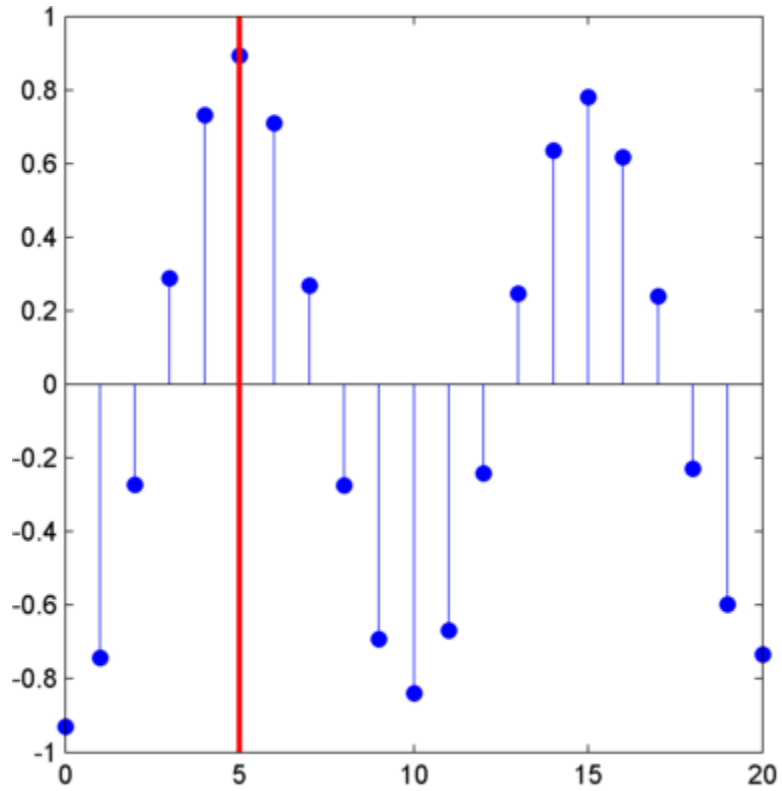

You see that the cross-correlation sequence peaks at lag 5 as expected and oscillates with a period of 10 samples.



# Multirate Signal Processing

---

- “Downsampling — Signal Phases” on page 11-2
- “Downsampling — Aliasing” on page 11-6
- “Filtering Before Downsampling” on page 11-12
- “Upsampling — Imaging Artifacts” on page 11-14
- “Filtering After Upsampling — Interpolation” on page 11-16
- “Changing Signal Sampling Rate” on page 11-18

## Downsampling – Signal Phases

These examples show how to use `downsample` to obtain the *phases* of a signal. Downsampling a signal by  $M$  can produce  $M$  unique phases. For example, if you have a discrete-time signal,  $x$ , with  $x(0) x(1) x(2) x(3), \dots$ , the  $M$  phases of  $x$  are  $x(nM+\lambda)$  with  $\lambda=0,1,\dots,M-1$ .

The  $M$  signals are referred to as the *polyphase* components of  $x$ .

Create a white noise vector and obtain the 3 polyphase components associated with downsampling by 3.

Reset the random number generator to the default settings to produce a repeatable result. Generate a white noise random vector and obtain the 3 polyphase components associated with downsampling by 3.

```
rng default;
x = randn(36,1);
x0 = downsample(x,3,0);
x1 = downsample(x,3,1);
x2 = downsample(x,3,2);
```

The polyphase components have length equal to  $1/3$  the original signal.

Upsample the polyphase components by 3 using `upsample`.

```
y0 = upsample(x0,3,0);
y1 = upsample(x1,3,1);
y2 = upsample(x2,3,2);
```

Plot the result.

```
subplot(411)
stem(x,'marker','none');
set(gca,'ylim',[-4 4]); title('Original Signal');
subplot(412)
stem(y0,'marker','none'); ylabel('Phase 0');
set(gca,'ylim',[-4 4]);
subplot(413)
stem(y1,'marker','none'); ylabel('Phase 1');
set(gca,'ylim',[-4 4]);
```

```
subplot(414)
stem(y2,'marker','none'); ylabel('Phase 2');
set(gca,'ylim',[-4 4]);
```

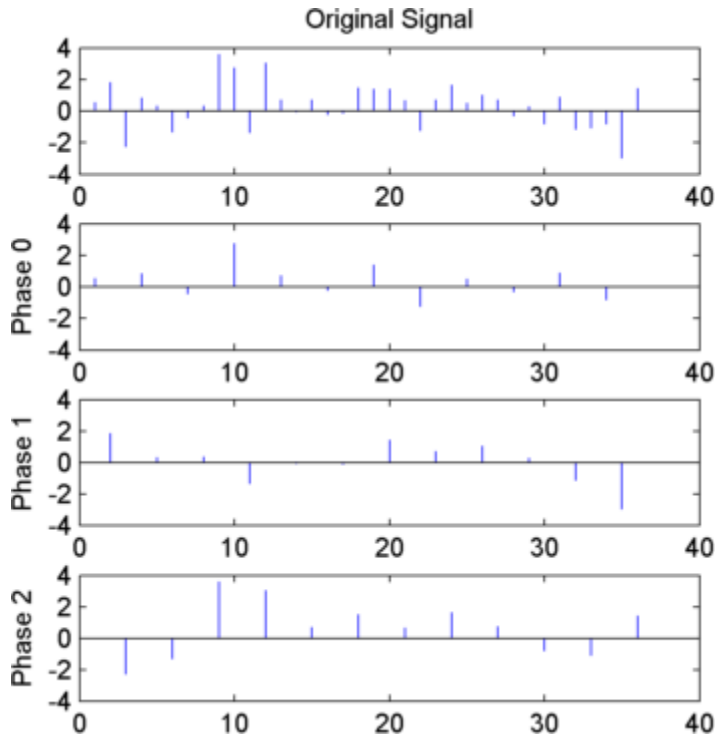

If you sum the upsampled polyphase components you obtain the original signal.

Create a discrete-time sinusoid and obtain the 2 polyphase components associated with downsampling by 2.

Create a discrete-time sine wave with an angular frequency of  $\pi/4$  radians/sample. Add a DC offset of 2 to the sine wave to help with visualization of the polyphase components. Downsample the sine wave by 2 to obtain the even and odd polyphase components.

```
n = 0:127;
```

```
x = 2+cos(pi/4*n);  
x0 = downsample(x,2,0);  
x1 = downsample(x,2,1);
```

Upsample the two polyphase components.

```
y0 = upsample(x0,2,0);  
y1 = upsample(x1,2,1);
```

Plot the upsampled polyphase components along with the original signal for comparison.

```
subplot(311)  
stem(x,'marker','none');  
set(gca,'ylim',[0.5 3.5]); title('Original Signal');  
subplot(312)  
stem(y0,'marker','none'); ylabel('Phase 0');  
set(gca,'ylim',[0.5 3.5]);  
subplot(313)  
stem(y1,'marker','none'); ylabel('Phase 1');  
set(gca,'ylim',[0.5 3.5]);
```

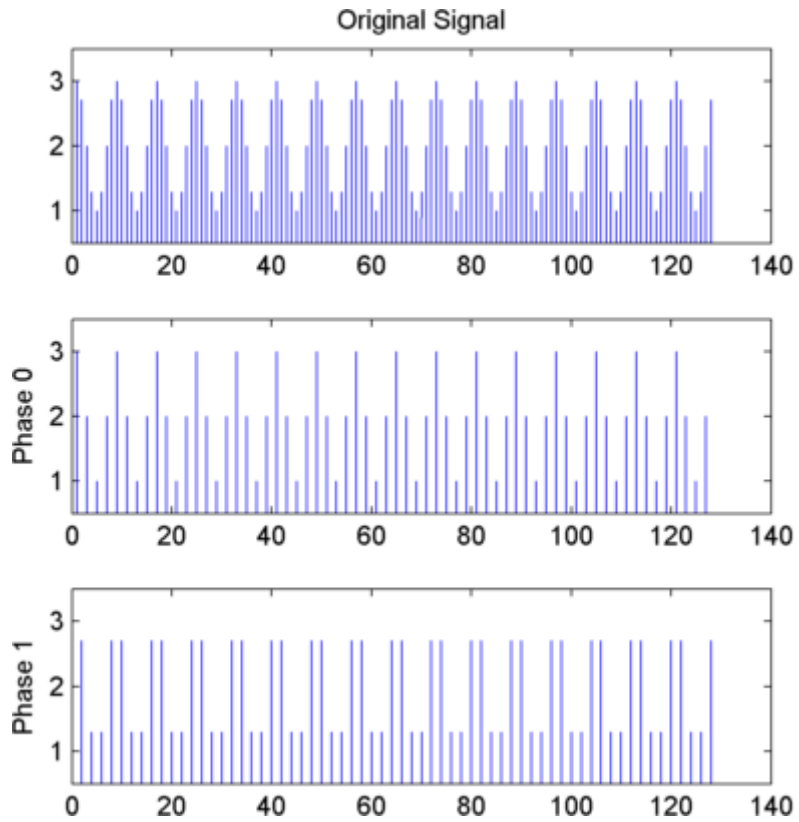

If you sum the two upsampled polyphase components (Phase 0 and Phase 1), you obtain the original sine wave.

## Downsampling – Aliasing

These examples show how downsampling can introduce aliasing. If a discrete-time signal's baseband spectral support is not limited to an interval of width  $2\pi/M$  radians, downsampling by  $M$  results in aliasing. Aliasing is the distortion that occurs when overlapping copies of the signal's spectrum are added together. The more the signal's baseband spectral support exceeds  $2\pi/M$  radians, the more severe the aliasing.

Demonstrate aliasing in a signal downsampled by two. The signal's baseband spectral support exceeds  $\pi$  radians in width.

Create a signal with baseband spectral support equal to  $3\pi/2$  radians. Use `fir2` to design the signal. Plot the signal's spectrum.

```
F = [0 0.2500 0.5000 0.7500 1.0000];
A = [1.00 0.6667 0.3333 0 0];
Order = 511;
B1 = fir2(Order,F,A);
[Hx,W] = freqz(B1,1,8192,'whole');
Hx = [Hx(4098:end) ; Hx(1:4097)];
omega = -pi+(2*pi/8192):(2*pi)/8192:pi;
plot(omega,abs(Hx));
set(gca,'xlim',[-pi pi]);
set(gca,'xtick',[-pi -pi/2 0 pi/2 pi]);
grid on;
title('Magnitude Spectrum');
xlabel('Radians/Sample'); ylabel('Magnitude');
```

You see that the signal's baseband spectral support exceeds  $[-\pi/2, \pi/2]$ .

Downsample the signal by a factor of 2 and plot the downsampled signal's spectrum with the spectrum of the original signal.

```
y = downsample(B1,2,0);
[Hy,W] = freqz(y,1,8192,'whole');
Hy = [Hy(4098:end) ; Hy(1:4097)];
hold on;
plot(omega,abs(Hy),'r','linewidth',2);
set(gca,'xlim',[-pi pi]);
```



```
legend('Original Signal','Downsampled Signal');
```

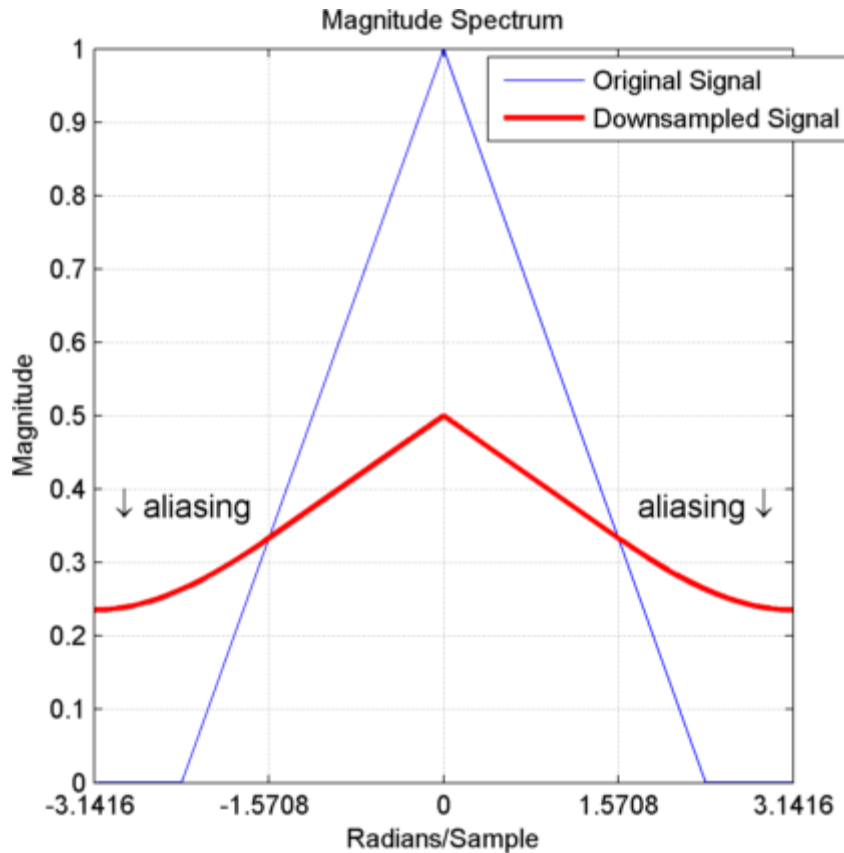

In addition to an amplitude scaling of the spectrum, the superposition of overlapping spectral replicas causes distortion of the original spectrum for  $|\omega| > \pi/2$ .

Increase the baseband spectral support of the signal to  $[-7\pi/8, 7\pi/8]$  and downsample the signal by 2. Plot the original spectrum along with the spectrum of the downsampled signal.

```
F = [0 0.2500 0.5000 0.7500 7/8 1.0000];
A = [1.00 0.7143 0.4286 0.1429 0 0];
Order = 511;
```

```
B2 = fir2(Order,F,A);
[Hx,W] = freqz(B2,1,8192,'whole');
Hx = [Hx(4098:end) ; Hx(1:4097)];
omega = -pi+(2*pi/8192):(2*pi)/8192:pi;
plot(omega,abs(Hx));
set(gca,'xlim',[-pi pi]);
y = downsample(B2,2,0);
[Hy,W] = freqz(y,1,8192,'whole');
Hy = [Hy(4098:end) ; Hy(1:4097)];
plot(omega,abs(Hx));
hold on;
plot(omega,abs(Hy),'r','linewidth',2);
set(gca,'xlim',[-pi pi]);
grid on;
legend('Original Signal','Downsampled Signal');
xlabel('Radians/Sample'); ylabel('Magnitude');
```

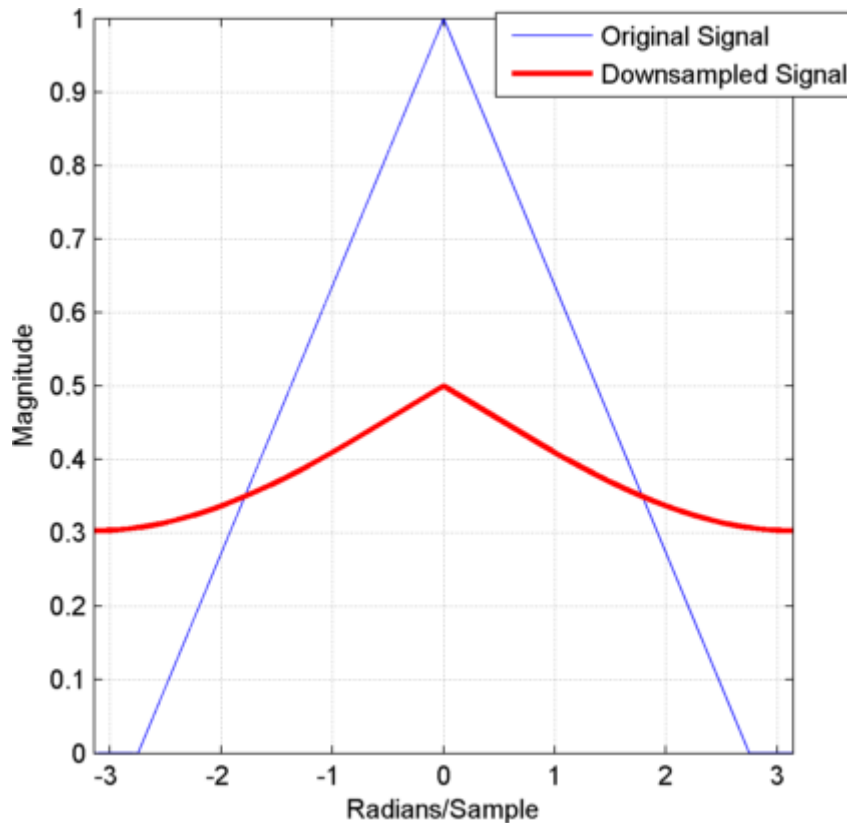

The increased spectral width results in more pronounced aliasing in the spectrum of the downsampled signal because more signal energy is outside  $[-\pi/2, \pi/2]$ .

Finally, construct a signal with baseband spectral support limited to  $[-\pi/2, \pi/2]$ . Downsample the signal by a factor of 2 and plot the spectrum of the original and downsampled signals. The downsampled signal is full band, but the shape of the spectrum is preserved because the spectral copies do not overlap. There is no aliasing.

```
F = [0 0.250 0.500 0.7500 1];
A = [1.0000 0.5000 0 0 0];
Order = 511;
```

```
B3 = fir2(Order,F,A);
[Hx,W] = freqz(B3,1,8192,'whole');
Hx = [Hx(4098:end) ; Hx(1:4097)];
omega = -pi+(2*pi/8192):(2*pi)/8192:pi;
plot(omega,abs(Hx));
set(gca,'xlim',[-pi pi]);
y = downsample(B3,2,0);
[Hy,W] = freqz(y,1,8192,'whole');
Hy = [Hy(4098:end) ; Hy(1:4097)];
plot(omega,abs(Hx));
hold on;
plot(omega,abs(Hy),'r','linewidth',2);
set(gca,'xlim',[-pi pi]);
grid on;
legend('Original Signal','Downsampled Signal');
xlabel('Radians/Sample'); ylabel('Magnititude');
```

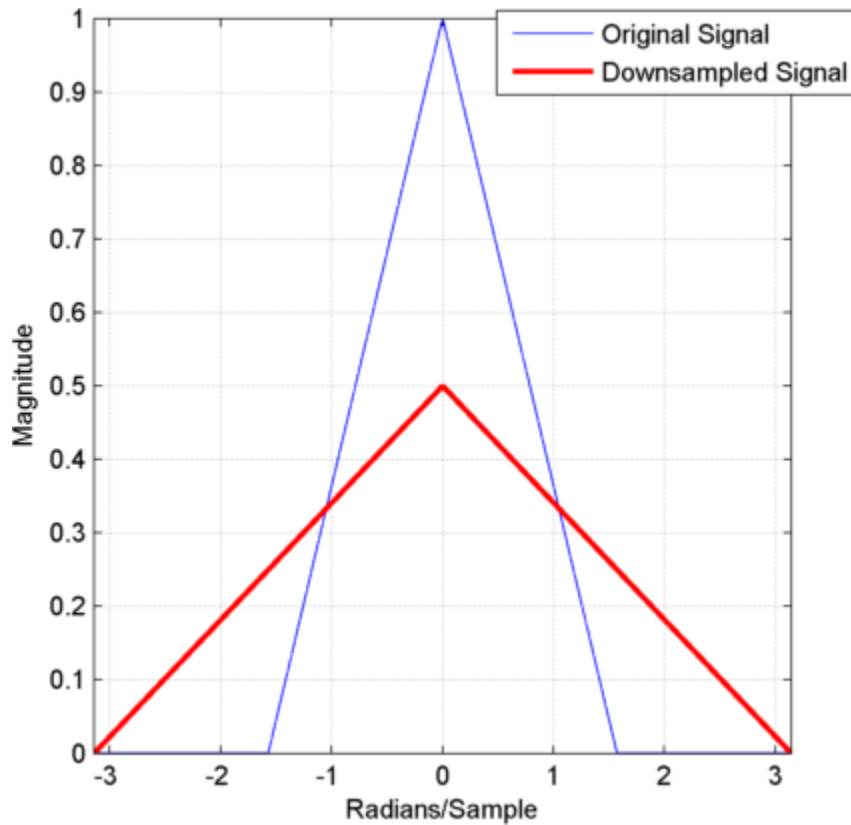

You see in the preceding figure that the shape of the spectrum is preserved. The spectrum of the downsampled signal is a stretched and scaled version of the original signal's spectrum, but there is no aliasing.

## Filtering Before Downsampling

This example shows how to filter before downsampling to mitigate the distortion caused by aliasing. You can use `decimate` or `resample` to filter and downsample with one function. Alternatively, you can lowpass filter your data and then use `downsample`.

Create a signal with baseband spectral support greater than  $\pi$  radians. Use `decimate` to filter the signal with a 10-th order Chebyshev type I lowpass filter prior to downsampling.

Create the signal and plot the magnitude spectrum.

```
F = [0 0.2500 0.5000 0.7500 1.0000];
A = [1.00 0.6667 0.3333 0 0];
Order = 511;
B = fir2(Order,F,A);
[Hx,W] = freqz(B,1,8192,'whole');
Hx = [Hx(4098:end) ; Hx(1:4097)];
omega = -pi+(2*pi/8192):(2*pi)/8192:pi;
plot(omega,abs(Hx));
set(gca,'xlim',[-pi pi]);
set(gca,'xtick',[-pi -3*pi/4 -pi/2 0 pi/2 3*pi/4 pi]);
grid on;
title('Magnitude Spectrum');
xlabel('Radians/Sample'); ylabel('Magnitude');
```

Filter the signal with a 10-th order type I Chebyshev lowpass filter and downsample by 2. Plot the magnitude spectra of the original signal along with the filtered and downsampled signal.

```
y = decimate(B,2,10);
[Hy,W] = freqz(y,1,8192,'whole');
Hy = [Hy(4098:end) ; Hy(1:4097)];
plot(omega,abs(Hx));
hold on;
plot(omega,abs(Hy),'r','linewidth',2);
set(gca,'xlim',[-pi pi]);
grid on;
legend('Original Signal','Downsampled Signal');
```

```
xlabel('Radians/Sample'); ylabel('Magnitude');
```

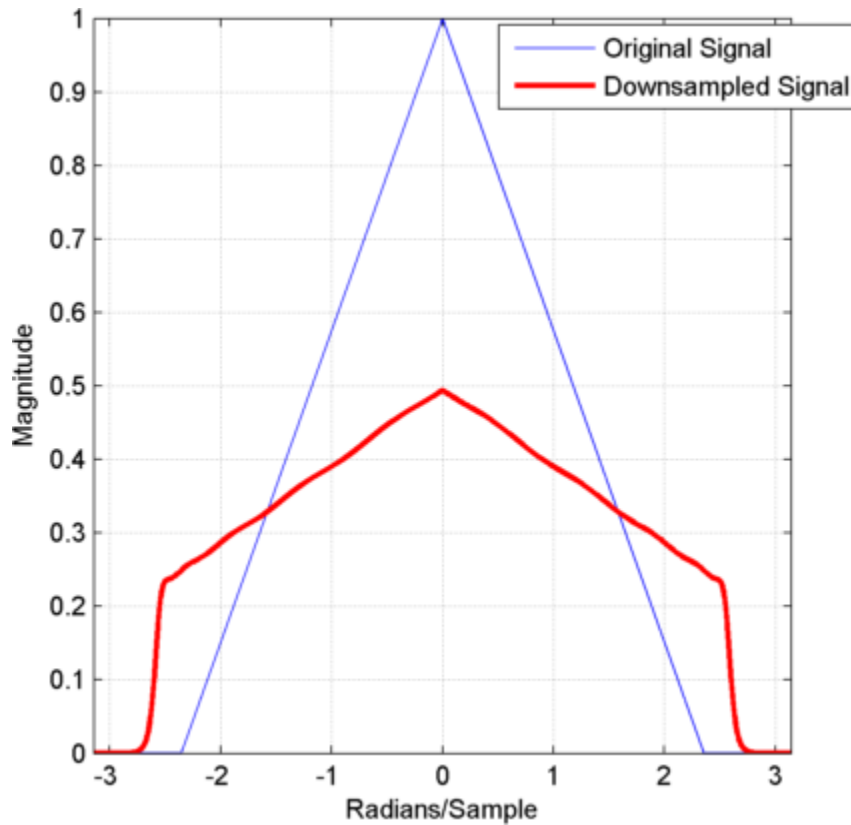

The lowpass filter reduces the amount of aliasing distortion outside the interval  $[-\pi/2, \pi/2]$ .

## Upsampling – Imaging Artifacts

This example shows how to upsample a signal and how upsampling can result in *images*. Upsampling a signal contracts the spectrum. For example, upsampling a signal by 2 results in a contraction of the spectrum by a factor of 2.

Because the spectrum of a discrete-time signal is  $2\pi$ -periodic, contraction can cause replicas of the spectrum normally outside of the baseband to appear inside the interval  $[-\pi, \pi]$ .

Create a signal with baseband spectral support from  $[-\pi/2, \pi/2]$ . Upsample the signal by a factor of 2 and demonstrate that upsampling results in images of the spectrum in  $[-\pi, \pi]$ .

Create a discrete-time signal whose baseband spectral support is  $[-\pi/2, \pi/2]$ . Plot the magnitude spectrum.

```
F = [0 0.250 0.500 0.7500 1];
A = [1.0000 0.5000 0 0 0];
Order = 511;
B = fir2(Order,F,A);
[Hx,W] = freqz(B,1,8192,'whole');
Hx = [Hx(4098:end) ; Hx(1:4097)];
omega = -pi+(2*pi/8192):(2*pi)/8192:pi;
plot(omega,abs(Hx));
```

Upsample the signal by 2. Plot the spectrum of the upsampled signal.

```
y = upsample(B,2);
[Hy,W] = freqz(y,1,8192,'whole');
Hy = [Hy(4098:end) ; Hy(1:4097)];
plot(omega,abs(Hx));
hold on;
plot(omega,abs(Hy),'r','linewidth',2);
set(gca,'xlim',[-pi pi]);
legend('Original Signal','Upsampled Signal');
xlabel('Radians/Sample'); ylabel('Magnitude');
```



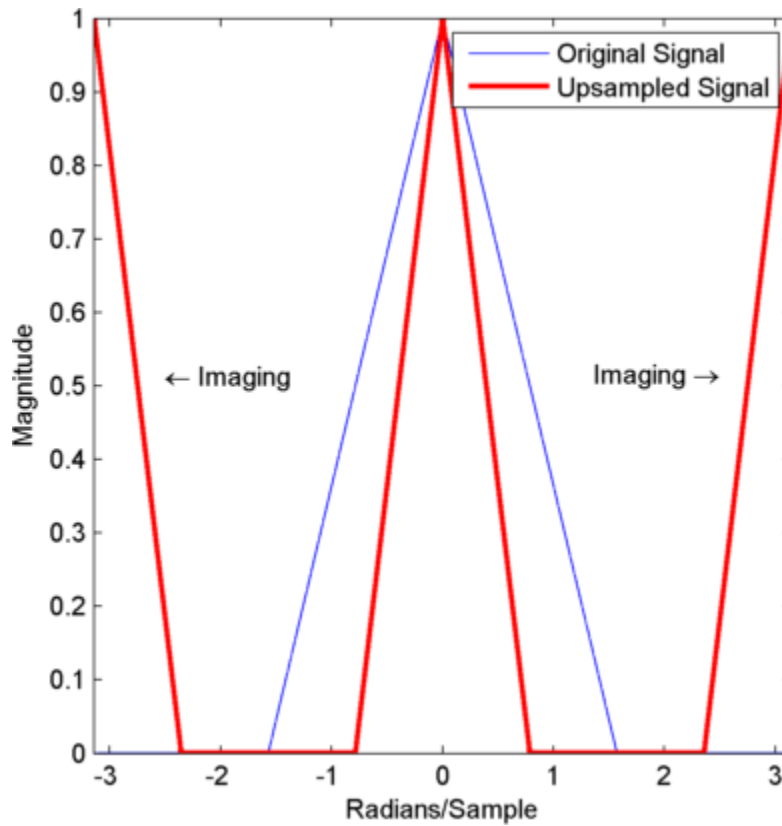

You can see in the preceding figure that the contraction of the spectrum has drawn subsequent periods of the spectrum into the interval  $[-\pi, \pi]$ .

## Filtering After Upsampling – Interpolation

This example shows how to upsample a signal and apply a lowpass interpolation filter with `interp`. Upsampling by  $L$  inserts  $L$  zeros between every element of the original signal. The example in “Upsampling — Imaging Artifacts” on page 11-14 shows that upsampling can create imaging artifacts. Lowpass filtering following upsampling can remove these imaging artifacts. In the time domain, lowpass filtering interpolates the zeros inserted by upsampling.

Create a signal with baseband spectral support from  $[-\pi/2, \pi/2]$ . Upsample the signal by a factor of 2 and use a lowpass filter to remove the images resulting from upsampling.

Create a discrete-time signal whose baseband spectral support is  $[-\pi/2, \pi/2]$ . Plot the magnitude spectrum.

```
F = [0 0.250 0.500 0.7500 1];
A = [1.0000 0.5000 0 0 0];
Order = 511;
B = fir2(Order,F,A);
[Hx,W] = freqz(B,1,8192,'whole');
Hx = [Hx(4098:end) ; Hx(1:4097)];
omega = -pi+(2*pi/8192):(2*pi)/8192:pi;
plot(omega,abs(Hx));
set(gca,'xlim',[-pi pi]);
xlabel('Radians/Sample'); ylabel('Magnitude');
```

Upsample the signal and apply a lowpass filter to remove the imaging artifacts. Plot the magnitude spectrum.

```
y = interp(B,2);
[Hy,W] = freqz(y,1,8192,'whole');
Hy = [Hy(4098:end) ; Hy(1:4097)];
hold on;
plot(omega,abs(Hy),'r','linewidth',2);
legend('Original Signal','Upsampled Signal');
```

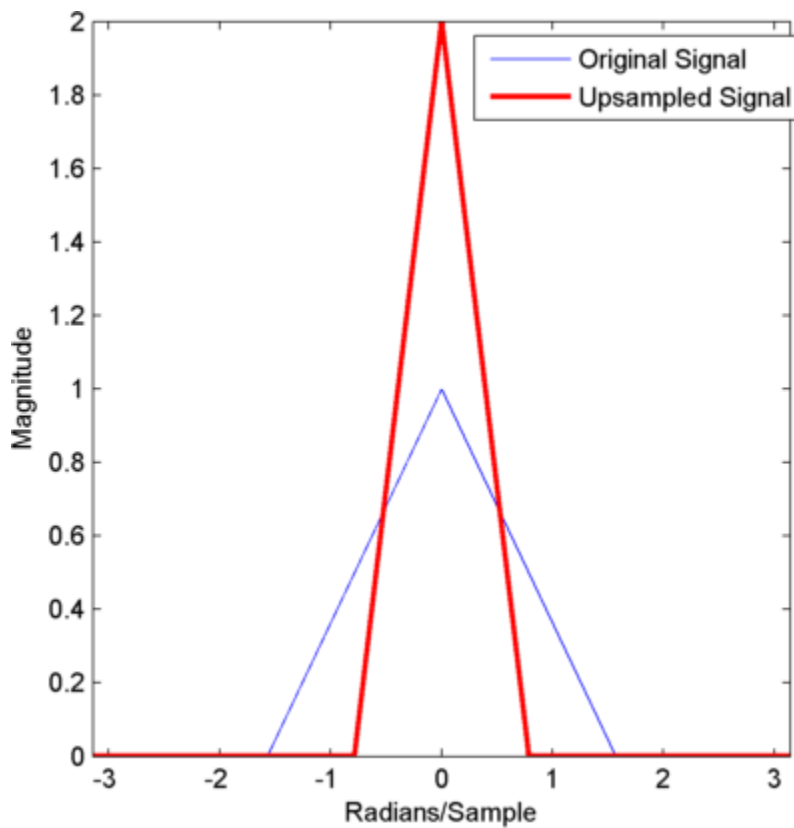

Upsampling still contracts the spectrum, but the imaging artifacts are removed by the lowpass filter.

## Changing Signal Sampling Rate

This example shows you how to change the sampling rate of a signal. Two examples are presented here. One example changes the sampling rate of a sinusoidal input from 44.1 kHz to 48 kHz. This workflow is common to audio processing. The sampling rate used on compact discs is 44.1 kHz, while the sampling rate used on digital audio tape is 48 kHz. The other example changes the sampling rate of a recorded speech sample from 7418 Hz to 8192 Hz.

Create an input signal consisting of a sum of sine waves sampled at 44.1 kHz. The sine waves have frequencies of 2, 4, and 8 kHz.

```
Fs = 44.1e3;  
t = 0:1/Fs:1-(1/Fs);  
x = cos(2*pi*2000*t)+1/2*sin(2*pi*4000*(t-pi/4))+1/4*cos(2*pi*8000*t);
```

To change the sampling rate from 44.1 to 48 kHz, you have to determine a rational number (ratio of integers),  $P/Q$ , such that  $P/Q$  times the original sampling rate, 44100, is equal to 48000 within some specified tolerance.

To determine these factors, use `rat`. Input the ratio of the new sampling rate, 48000, to the original sampling rate, 44100.

```
[P,Q] = rat(48e3/Fs);  
abs(P/Q*Fs-48000)
```

You see that  $P/Q*Fs$  only differs from the desired sampling rate, 48000, on the order of  $10^{-12}$ .

Use the numerator and denominator factors obtained with `rat` as inputs to `resample` to output a waveform sampled at 48 kHz.

```
xnew = resample(x,P,Q);
```

If your computer can play audio, you can play the two waveforms. Set the volume to a comfortable level before you play the signals. Execute the `play` commands separately so that you can hear the signal with the two different sampling rates.

```
P44_1 = audioplayer(x,44100);  
P48 = audioplayer(xnew,48000);
```

```
play(P44_1)
play(P48)
```

Change the sampling rate of a speech sample from 7418 Hz to 8192. The speech signal is a recording of a speaker saying “MATLAB”.

Load the speech sample.

```
load mtlb
```

Loading the file `mtlb.mat` brings the speech signal, `mtlb`, and the sampling rate, `Fs`, into the MATLAB workspace.

Determine a rational approximation to the ratio of the new sample rate, 8192, to the original sample rate. Use `rat` to determine the approximation.

```
[P,Q] = rat(8192/Fs);
```

Resample the speech sample at the new sampling rate.

```
mtlb_new = resample(mtlb,P,Q);
```

If your computer has audio output capability, you can play the two waveforms at their respective sampling rates for comparison. Set the volume on your computer to a comfortable listening level before playing the sounds. Execute the `play` commands separately to compare the speech samples at the different sampling rates.

```
Pmtlb = audioplayer(mtlb,Fs);
Pmtlb_new = audioplayer(mtlb_new,8192);
play(Pmtlb)
play(Pmtlb_new)
```



# Spectral Analysis

---

- “Power Spectral Density Estimates Using FFT” on page 12-2
- “Bias and Variability in the Periodogram” on page 12-10
- “Cross Spectrum and Magnitude-Squared Coherence” on page 12-20
- “Amplitude Estimation and Zero Padding” on page 12-24
- “Significance Testing for Periodic Component” on page 12-27
- “Frequency Estimation by Subspace Methods” on page 12-29
- “Frequency-Domain Linear Regression” on page 12-32

## Power Spectral Density Estimates Using FFT

These examples show how to obtain nonparametric power spectral density (PSD) estimates equivalent to the periodogram using `fft`. The examples show you how to properly scale the output of `fft` for even-length inputs, for normalized frequency and hertz, and for one- and two-sided PSD estimates.

Obtain the periodogram for an even-length signal sampled at 1 kHz using both `fft` and `periodogram`. Compare the results.

Create a signal consisting of a 100-Hz sine wave in  $N(0,1)$  additive noise. The sampling frequency is 1 kHz. The signal length is 1000 samples. Use the default settings of the random number generator for reproducible results.

```
rng default;
Fs = 1000;
t = linspace(0,1,1000);
x = cos(2*pi*100*t)+randn(size(t));
```

Obtain the periodogram using `fft`. The signal is real-valued and has even length. Because the signal is real-valued, you only need power estimates for the positive or negative frequencies. In order to conserve the total power, multiply all frequencies that occur in both sets — the positive and negative frequencies — by a factor of 2. Zero frequency (DC) and the Nyquist frequency do not occur twice. Plot the result.

```
N = length(x);
xdft = fft(x);
xdft = xdft(1:N/2+1);
psdx = (1/(Fs*N)).*abs(xdft).^2;
psdx(2:end-1) = 2*psdx(2:end-1);
freq = 0:Fs/length(x):Fs/2;
plot(freq,10*log10(psdx)); grid on;
title('Periodogram Using FFT');
xlabel('Frequency (Hz)'); ylabel('Power/Frequency (dB/Hz)');
```



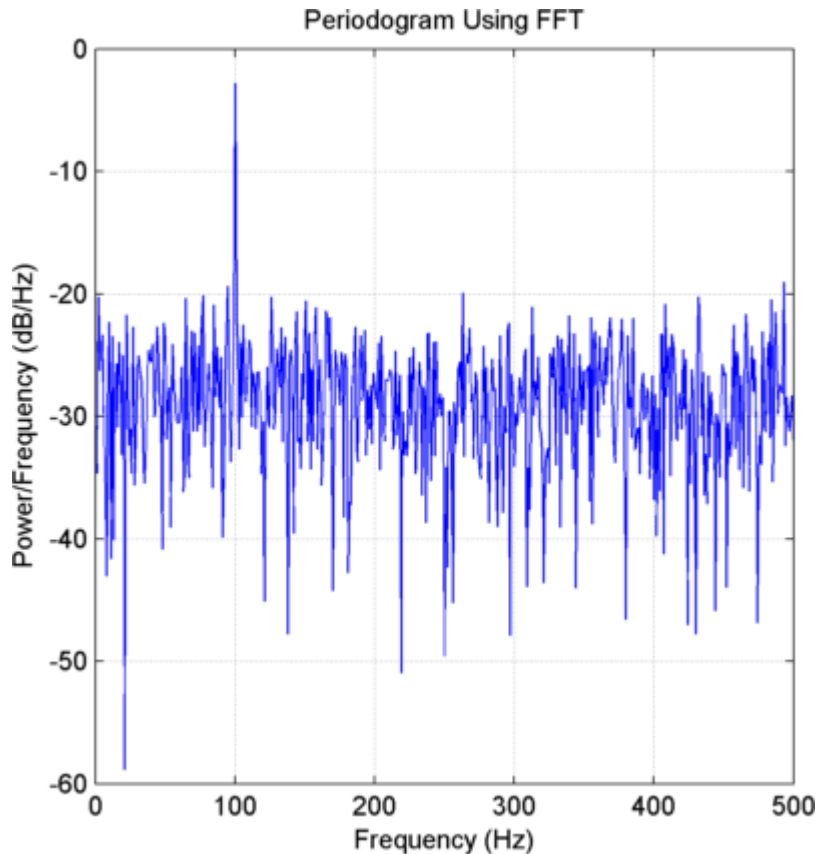

Compute and plot the periodogram using `periodogram`. Show that the 2 results are identical.

```
figure;
[psdestx,Fxx] = periodogram(x,rectwin(length(x)),length(x),Fs);
plot(Fxx,10*log10(psdestx)); grid on;
xlabel('Hz'); ylabel('Power/Frequency (dB/Hz)');
title('Periodogram Power Spectral Density Estimate');
max(psdx'-psdestx)
```

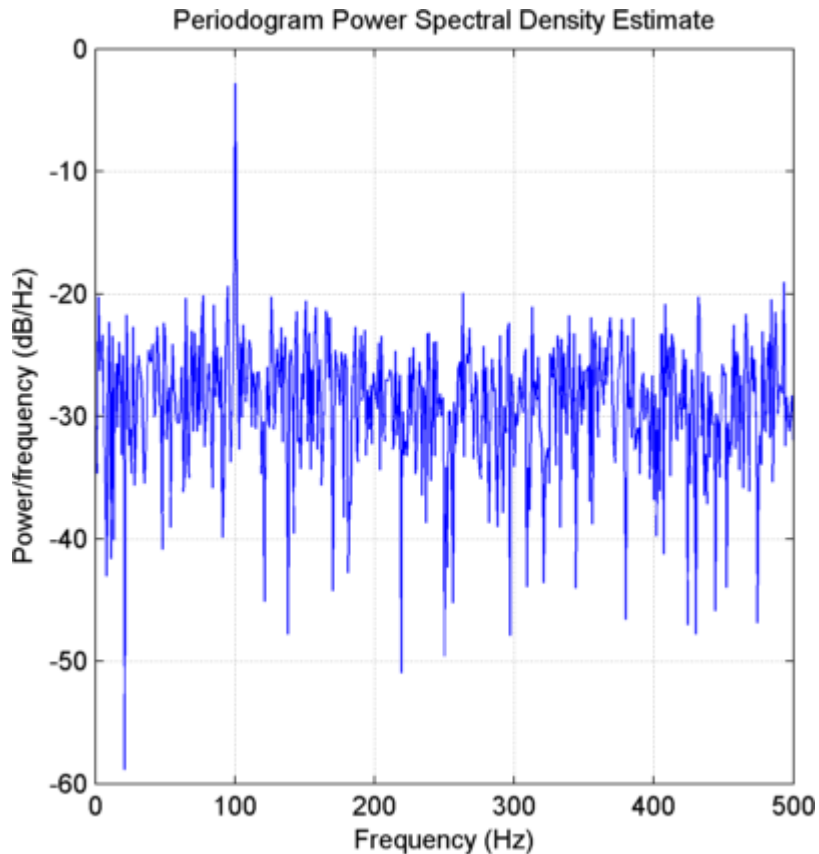

Use `fft` to produce a periodogram for an input using normalized frequency.

Create a signal consisting of a sine wave in  $N(0,1)$  additive noise. The sine wave has an angular frequency of  $\pi/4$  radians/sample. Use the default settings of the random number generator for reproducible results.

```
rng default;
n = 0:999;
x = cos(pi/4*n)+randn(size(n));
```

Obtain the periodogram using `fft`. The signal is real-valued and has even length. Because the signal is real-valued, you only need power estimates for the positive or negative frequencies. In order to conserve the total power,

multiply all frequencies that occur in both sets — the positive and negative frequencies — by a factor of 2. Zero frequency (DC) and the Nyquist frequency do not occur twice. Plot the result.

```
N = length(x);
xdft = fft(x);
xdft = xdft(1:N/2+1);
psdx = (1/(2*pi*N)).*abs(xdft).^2;
psdx(2:end-1) = 2*psdx(2:end-1);
freq = 0:(2*pi)/N:pi;
plot(freq./pi,10*log10(psdx)); grid on;
title('Periodogram Using FFT');
xlabel('Normalized Frequency');
ylabel('Power/Frequency (dB/rad/sample)');
```

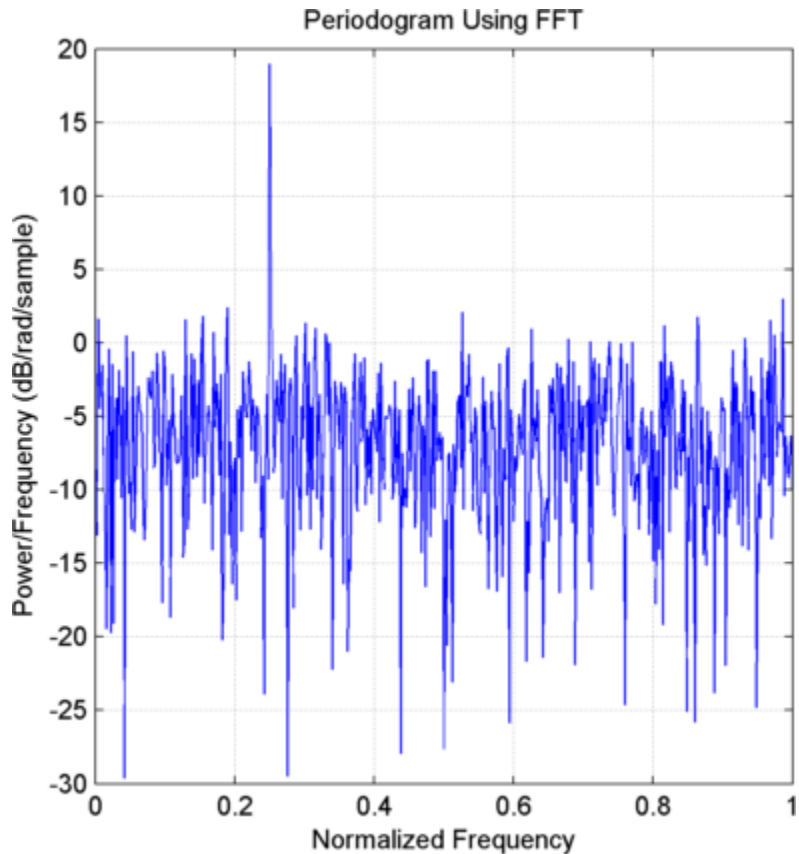

Compute and plot the periodogram using `periodogram`. Show that the 2 results are identical.

```
figure;
[psdestx,Fxx] = periodogram(x,rectwin(length(x)),length(x));
plot(Fxx./pi,10*log10(psdestx));
xlabel('Hz'); ylabel('Power/Frequency (dB/Hz)');
title('Periodogram Power Spectral Density Estimate');
xlabel('Normalized Frequency'); grid on;
ylabel('Power/Frequency (dB/rad/sample)');
max(psdx'-psdestx)
```

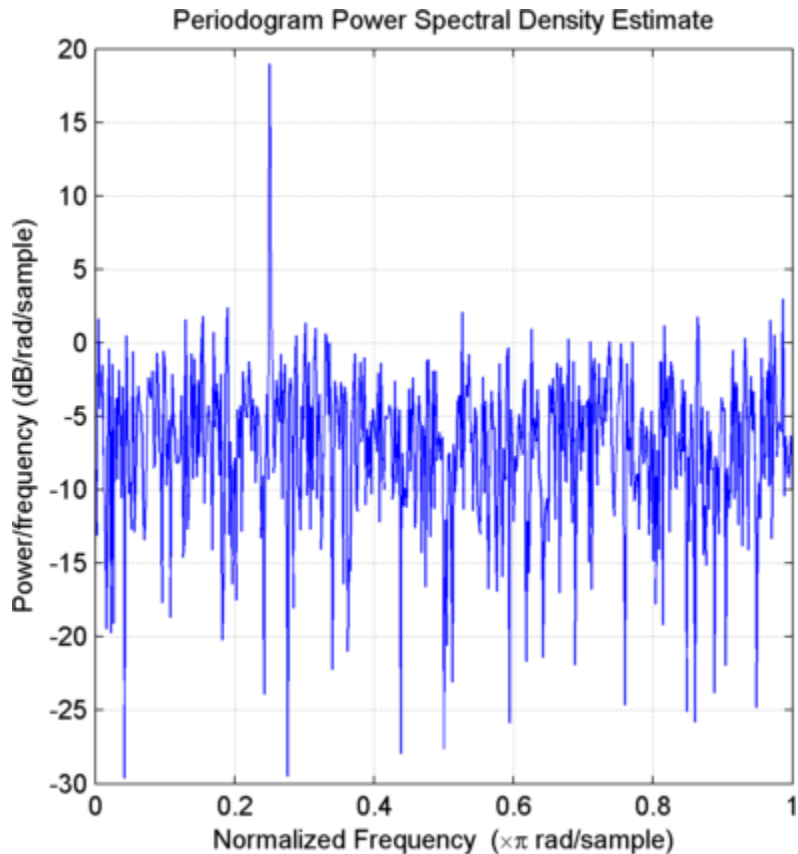

Use `fft` to produce a periodogram for a complex-valued input with normalized frequency.

Create the complex-valued signal. The signal is a complex exponential with an angular frequency of  $\pi/4$  radians/sample in complex-valued  $N(0,1)$  noise. Set the random number generator to the default settings for reproducible results.

```
rng default;
n = 0:999;
x = exp(1j*pi/4*n)+1/sqrt(2)*randn(size(n))+1j*1/sqrt(2)*randn(size(n));
```

Use `fft` to obtain the periodogram. Because the input is complex-valued, obtain the periodogram from  $(-\pi, \pi]$  radians/sample. Plot the result.

```

N = length(x);
xdft = fft(x);
psdx = (1/(2*pi*N)).*abs(xdft).^2;
freq = 0:(2*pi)/N:2*pi-(2*pi)/N;
plot(freq./pi,10*log10(psdx)); grid on;
title('Periodogram Using FFT');
xlabel('Normalized Frequency');
ylabel('Power/Frequency (dB/rad/sample)');

```

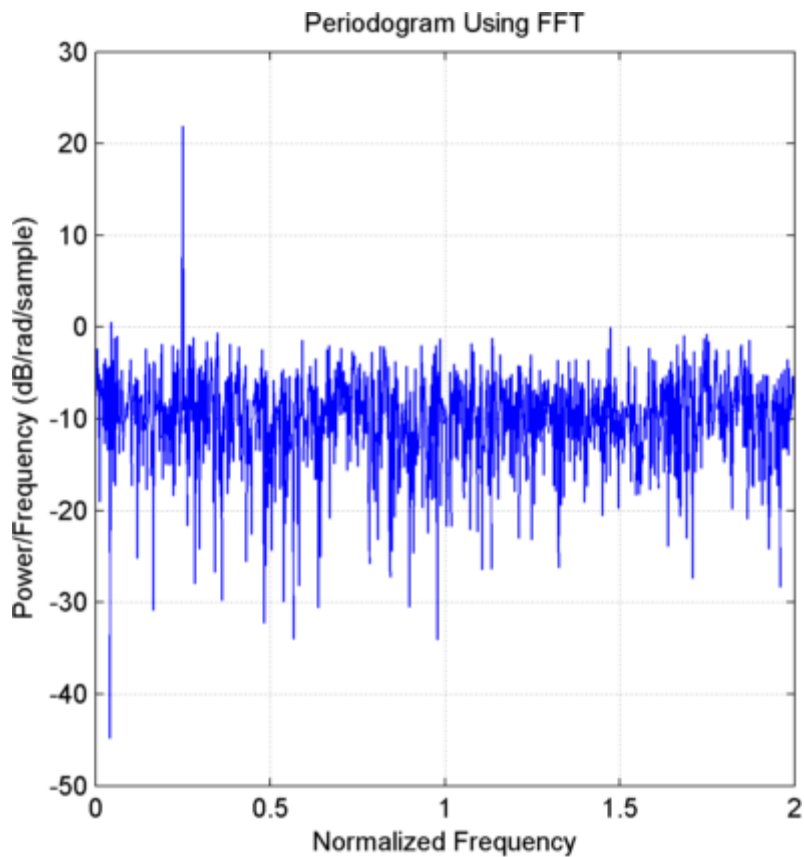

Use periodogram to obtain and plot the periodogram. Compare the PSD estimates.

```
[psdestx,Fxx] = periodogram(x,rectwin(length(x)),length(x),'twosided');
```

```
figure;  
plot(Fxx./pi,10*log10(psdestx));  
grid on; xlabel('Normalized Frequency');  
ylabel('Power/Frequency (dB/rad/sample)');  
title('Periodogram Power Spectral Density Estimate');  
max(psdx'-psdestx)
```

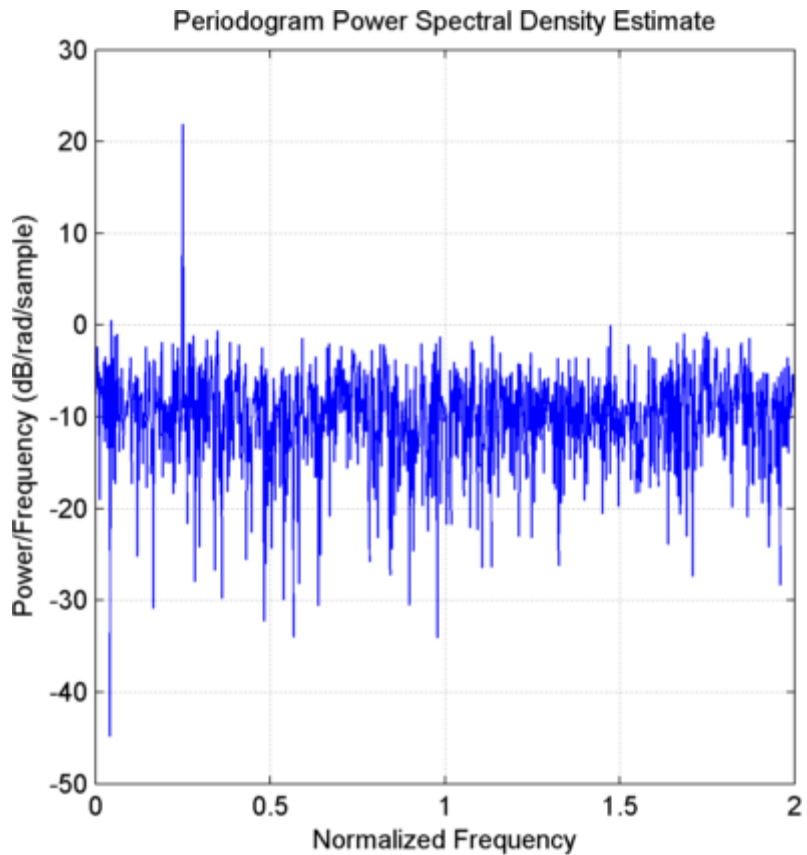

## Bias and Variability in the Periodogram

These examples show how to reduce bias and variability in the periodogram. Using a window can reduce the bias in the periodogram and using windows with averaging can reduce variability.

The periodogram suffers from two well-known problems, bias and inconsistency. Bias is introduced by the convolution of the true spectral density with Fejer's kernel. The periodogram is not a consistent estimator of the true spectral density because the variance of the periodogram does not decay to zero regardless of the sample size.

The periodogram also exhibits a high degree of variability because of the small number of degrees of freedom. The periodogram estimates at the Fourier frequencies are chi-square random variables with two degrees of freedom except at zero and Nyquist, which only exhibit one degree of freedom.

Bias in the periodogram can be mitigated by *tapering*, or windowing the time series before computing the PSD estimate. Inconsistency is addressed by using *Welch's overlapped segment averaging* approach, or a *multitaper* estimate.

Use wide-sense stationary autoregressive processes (AR) processes to show the effects of bias and variability in the periodogram. AR processes present a convenient model because their PSDs have closed-form expressions. Create an AR(2) model of the following form:

$$y(n) - 0.75y(n-1) + 0.5y(n-2) = \varepsilon(n),$$

where  $\varepsilon(n)$  is a zero mean white noise sequence with some specified variance. In this example, assume the variance and the sampling period to be 1.

To simulate the preceding AR(2) process, create an all-pole (IIR) filter. View the filter's magnitude response.

```
B2 = 1;  
A2 = [1 -0.75 0.5];  
fvtool(B2,A2);
```



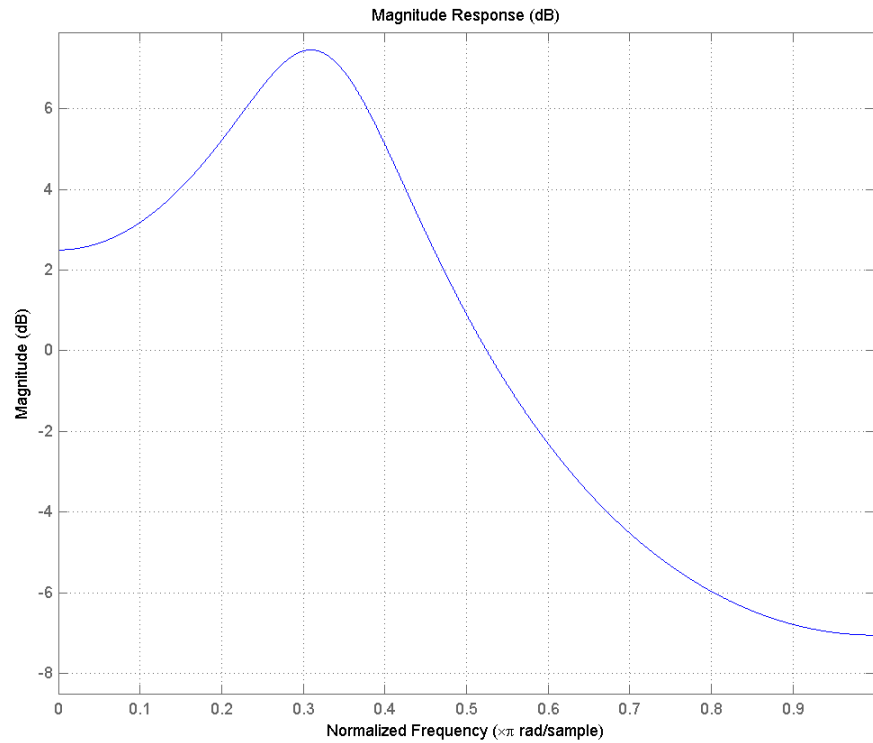

This process is bandpass. The dynamic range of the PSD is approximately 14.5 dB, you can determine this with the following code.

```
[H2,W2] = freqz(B2,A2,1e3,1);  
max(20*log10(abs(H2))) - min(20*log10(abs(H2)))
```

By examining the placement of the poles, you see that this AR(2) process is stable. The two poles are inside the unit circle.

```
fvtool(B2,A2,'analysis','polezero');
```

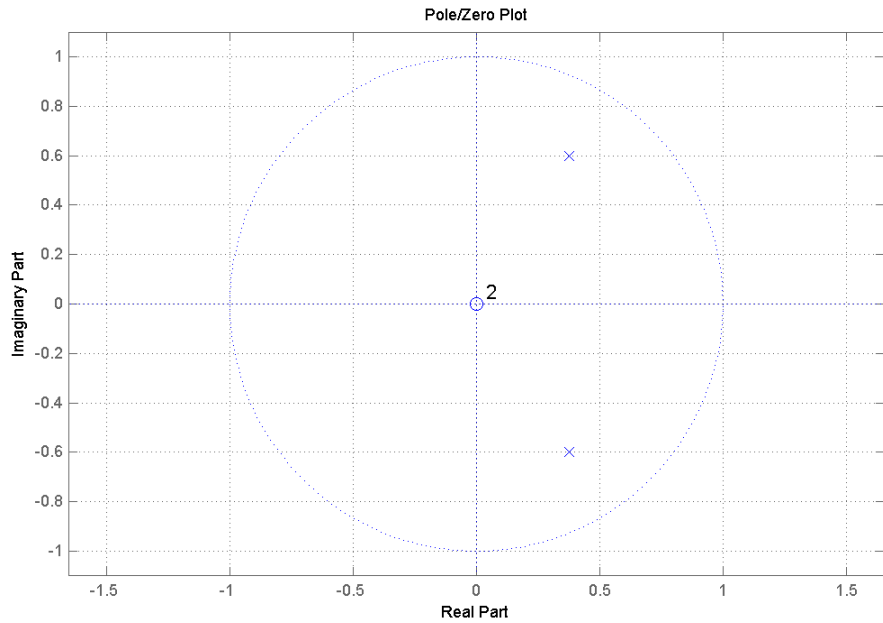

Create an AR(4) process described by the following equation:

$$y(n) - 2.7607y(n-1) + 3.8106y(n-2) - 2.6535y(n-3) + 0.9238y(n-4) = \varepsilon(n)$$

Use the following code to view the magnitude response of this IIR system.

```
B4 = 1;
A4 = [1 -2.7607 3.8106 -2.6535 0.9238];
fvtool(B4,A4);
```

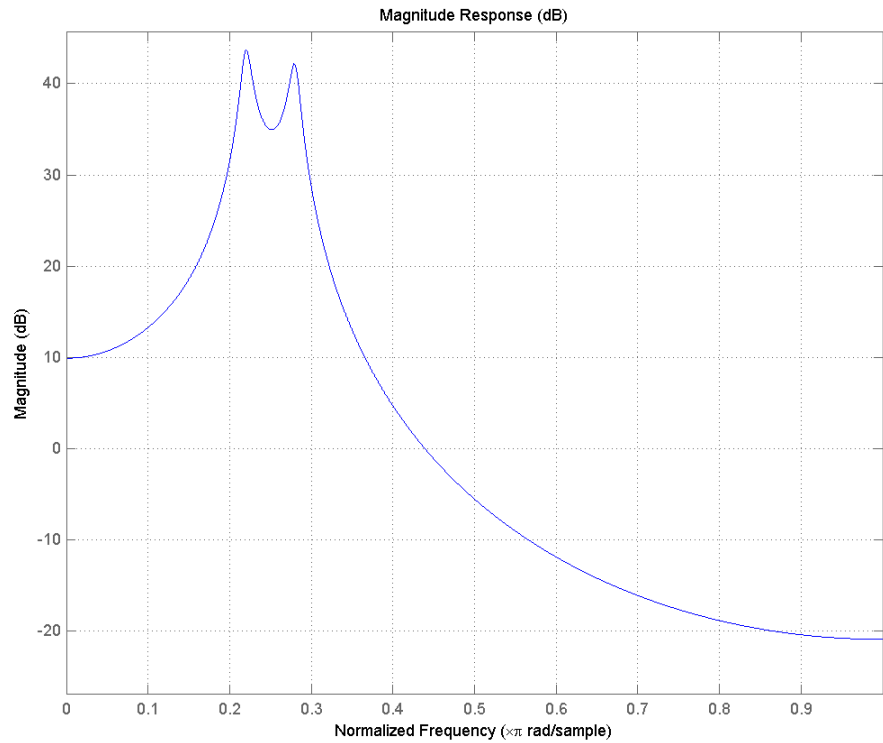

Examining the placement of the poles, you can see this AR(4) process is also stable. The four poles are inside the unit circle.

```
fvtool(B4,A4,'analysis','polezero');
```

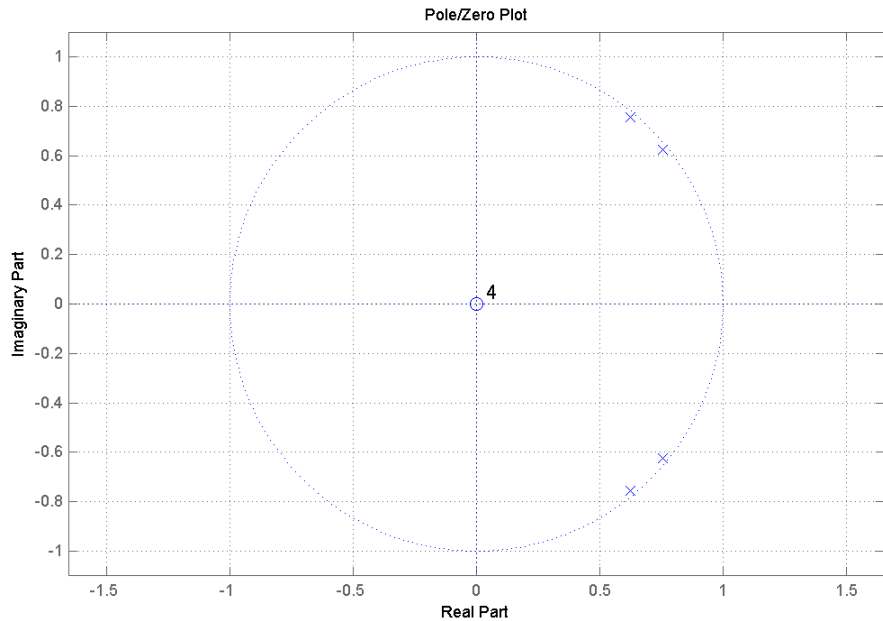

The dynamic range of this PSD is approximately 65 dB, much larger than the AR(2) model.

```
[H4,W4] = freqz(B4,A4,1e3,1);
max(20*log10(abs(H4))) - min(20*log10(abs(H4)))
```

To simulate realizations from these AR(p) processes, use `randn` and `filter`. Set the random number generator to the default settings to produce repeatable results. Plot the realizations.

```
rng default;
x = randn(1e3,1);
y2 = filter(B2,A2,x);
y4 = filter(B4,A4,x);
```

```
subplot(211)
plot(y2); title('AR(2) Process');
xlabel('Time'); ylabel('Amplitude');
subplot(212);
plot(y4); title('AR(4) Process');
xlabel('Time'); ylabel('Amplitude');
```

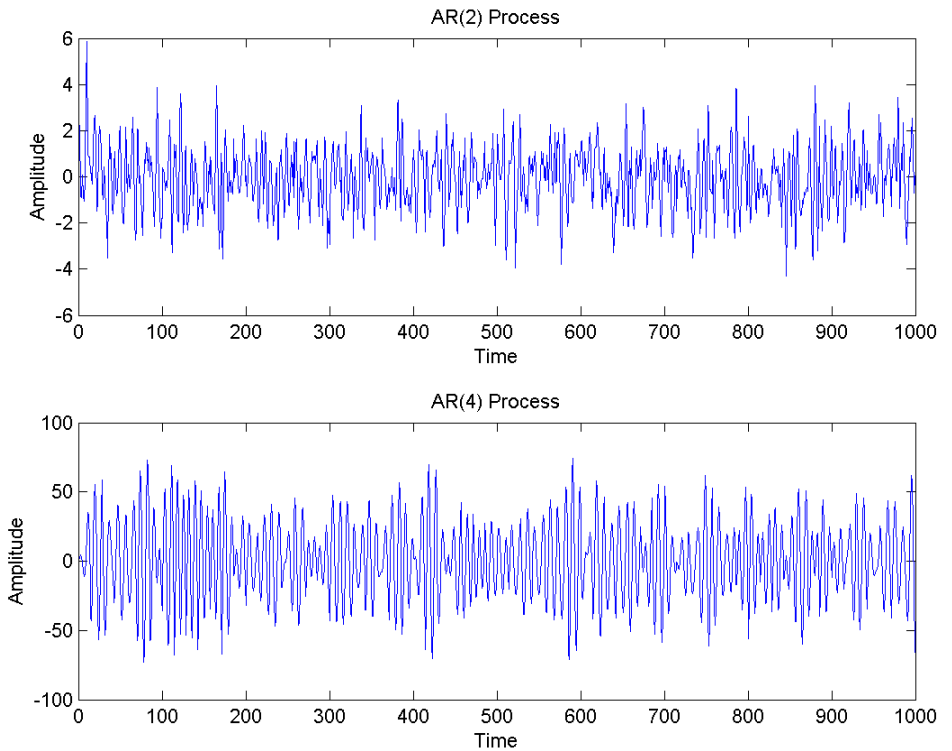

Compute the periodograms of the AR(2) and AR(4) realizations. Plot the result and compare the periodogram against the true PSD.

```
Fs = 1;
NFFT = length(y2);
[psdAR2,Fxx] = periodogram(y2,rectwin(length(y2)),length(y2),1);
psdAR4 = periodogram(y4,rectwin(length(y2)),length(y2),1);
```

```

subplot(211)
plot(Fxx,10*log10(psdAR2));
hold on;
plot(W2,20*log10(abs(H2)), 'r', 'linewidth',2);
title('AR(2) PSD and Periodogram');
subplot(212)
plot(Fxx,10*log10(psdAR4));
hold on;
plot(W4,20*log10(abs(H4)), 'r', 'linewidth',2);
xlabel('Hz'); ylabel('dB');
title('AR(4) PSD and Periodogram');

```

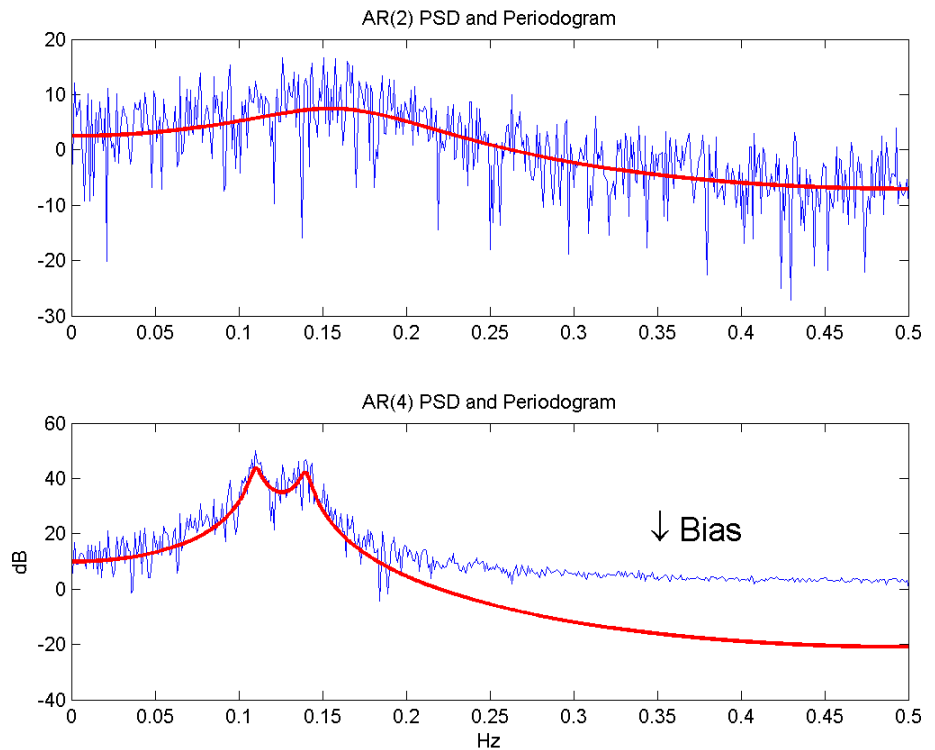

In the case of the AR(2) process, the periodogram estimate follows the shape of the true PSD but exhibits considerable variability. This is due to the low degrees of freedom. The pronounced negative deflections (in dB) in the periodogram are explained by taking the log of a chi-square random variable with two degrees of freedom.

In the case of the AR(4) process, the periodogram follows the shape of the true PSD at low frequencies but deviates from the PSD in the high frequencies. This is the effect of the convolution with Fejer's kernel. The large dynamic range of the AR(4) process compared to the AR(2) process is what makes the bias more pronounced.

Mitigate the bias demonstrated in the AR(4) process by using a taper, or window. In this example, use a Hamming window to taper the AR(4) realization before obtaining the periodogram.

```
[psdAR4H,Fxx] = periodogram(y4,hamming(length(y4)),NFFT,Fs);
plot(Fxx,10*log10(psdAR4H));
hold on;
plot(W4,20*log10(abs(H4)),'r','linewidth',2);
xlabel('Hz'); ylabel('dB');
title('AR(4) PSD and Periodogram with Hamming Window');
legend('Periodogram with Hamming Window','AR(4) PSD',...
      'Location','NorthEast');
```

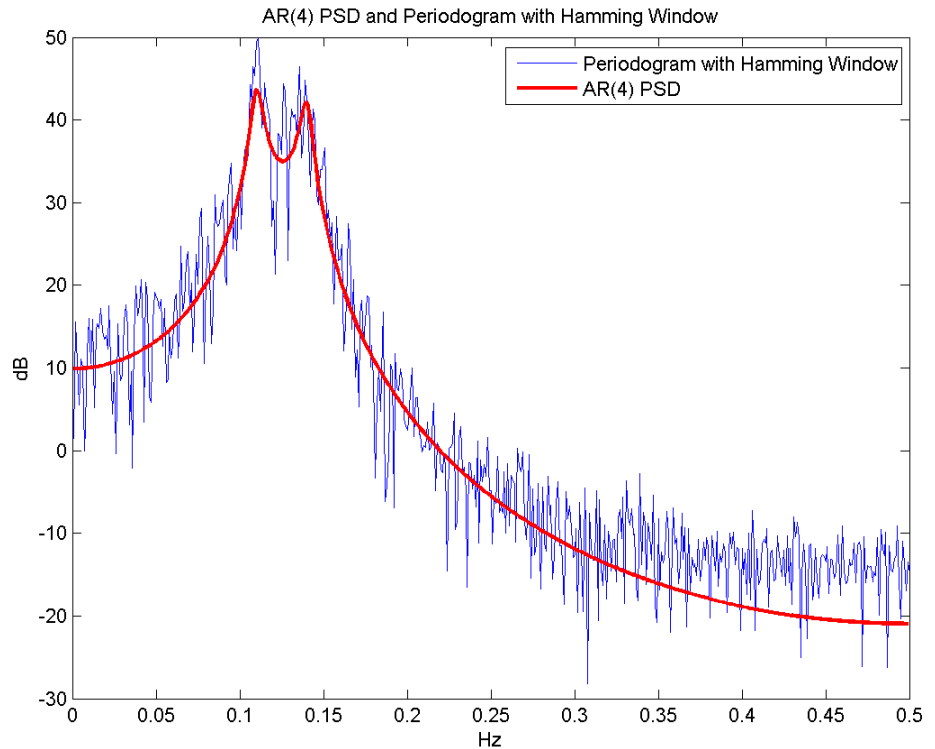

Note that the periodogram estimate now follows the true AR(4) PSD over the entire  $[0, \text{Nyquist}]$  frequency range. The periodogram estimates still only have two degrees of freedom so the use of a window does not reduce the variability of periodogram, but it does address bias.

In nonparametric spectral estimation, two methods for increasing the degrees of freedom and reducing the variability of the periodogram are Welch's overlapped segment averaging and multitaper spectral estimation.

Obtain a multitaper estimate of the AR(4) time series using a time half bandwidth product of 3.5. Plot the result.

```
NW = 3.5;
[psdmtm, Fxx] = pmtm(y4, NW, NFFT, Fs);
```



```
plot(Fxx,10*log10(psdmtm));  
hold on;  
plot(W4,20*log10(abs(H4)), 'r', 'linewidth',2);  
xlabel('Hz'); ylabel('dB');  
legend('Multitaper Estimate','AR(4) PSD', ...  
      'Location','NorthEast');
```

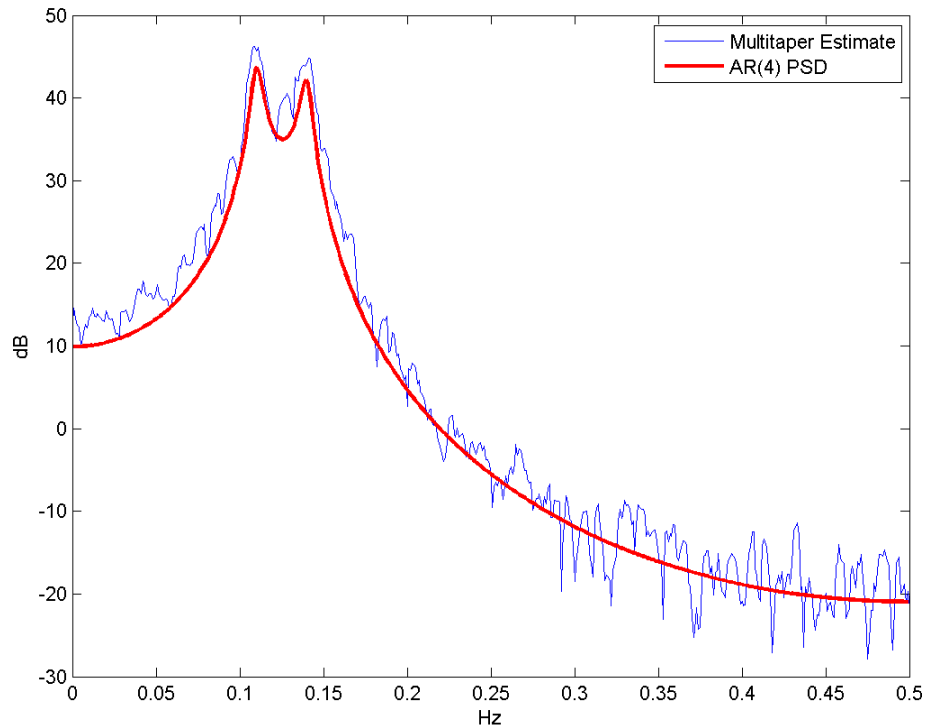

The multitaper method produces a PSD estimate with significantly less variability than the periodogram. Because the multitaper method also uses *windows*, you see that the bias of the periodogram is also addressed.

## Cross Spectrum and Magnitude-Squared Coherence

This example shows how to use the cross spectrum to obtain the phase lag between sinusoidal components in a bivariate time series. The example also uses the magnitude-squared coherence (MSC) to identify significant frequency-domain correlation at the sine wave frequencies.

Create the bivariate time series. The individual series consist of two sine waves with frequencies of 100 and 200 Hz in additive white Gaussian noise. The sine waves in the  $x$ -series both have amplitudes equal to 1. The 100-Hz sine wave in the  $y$ -series has amplitude 0.5 and the 200-Hz sine wave in the  $y$ -series has amplitude 0.35. The sine waves in the  $y$ -series are phase-lagged by  $\pi/4$  radians (100 Hz) and  $\pi/2$  radians (200 Hz). You can think of  $y$ -series as the noise-corrupted output of a linear system with input  $x$ . In the following code, set the random number generator to the default settings for reproducible results.

```

Fs = 1000;
t = 0:1/Fs:1-1/Fs;
rng default;
x = cos(2*pi*100*t)+sin(2*pi*200*t)+0.5*randn(size(t));
y = 0.5*cos(2*pi*100*t-pi/4)+0.35*sin(2*pi*200*t-pi/2)+0.5*randn(size(t));

```

Obtain the magnitude-squared coherence (MSC) for the bivariate time series. The magnitude-squared coherence enables you to identify significant frequency-domain correlation between the two time series. Phase estimates in the cross spectrum are only useful where significant frequency-domain correlation exists.

To prevent obtaining a magnitude-squared coherence estimate, which is identically 1 for all frequencies, you must use an averaged MSC estimator. Both Welch's overlapped segment averaging (WOSA) and multitaper techniques are appropriate. `mscohere` implements a WOSA estimator.

Set the window length to 100 samples. This window length contains 10 periods of the 100-Hz sine wave and 20 periods of the 200-Hz sine wave. Use an overlap of 80 samples with the default Hamming window. Plot the magnitude-squared coherence.

```
[Pxy,F] = mscohere(x,y,hamming(100),80,100,Fs);
```

```
plot(F,Pxy,'linewidth',2); title('Magnitude-squared Coherence');
xlabel('Hz'); grid on;
```

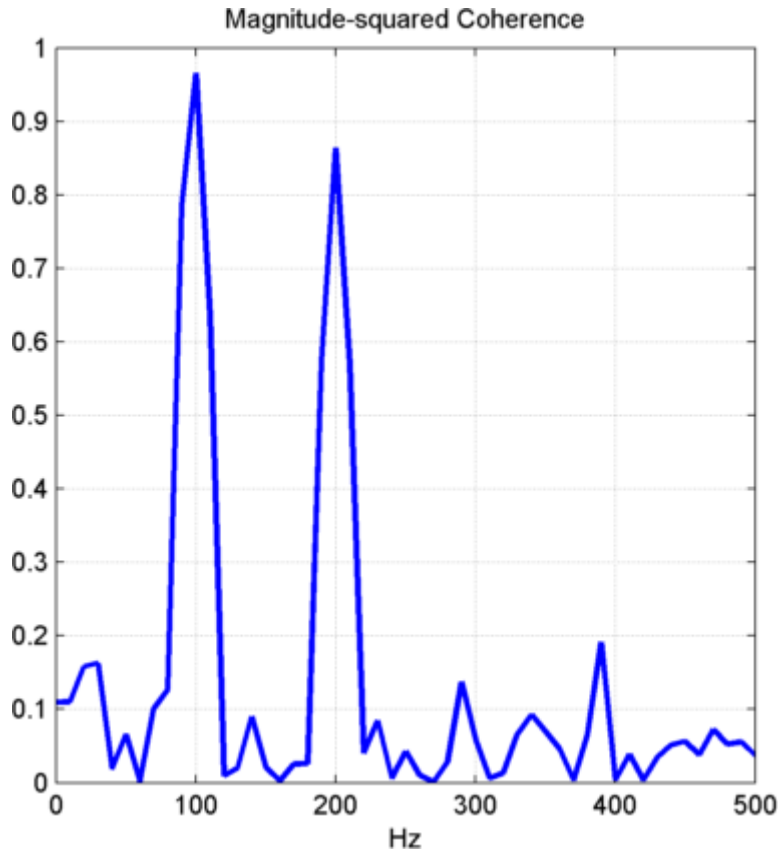

You see that the magnitude-squared coherence is greater than 0.8 at 100 and 200 Hz.

Obtain the cross spectrum of  $x$  and  $y$  using `cpsd`. Use the same parameters to obtain the cross spectrum that you used in the MSC estimate. Plot the phase of the cross spectrum and indicate the frequencies with significant coherence between the two times. Mark the known phase lags between the sinusoidal components.

```
[Cxy,F] = cpsd(x,y,hamming(100),80,100,Fs);
```

```

figure;
plot(F,-angle(Cxy),'linewidth',2); title('Cross Spectrum Phase');
xlabel('Radians');
set(gca,'xtick',[100 200]);
set(gca,'ytick',[-pi -pi/2 -pi/4 0 pi/4 pi/2 pi]);
grid on;

```

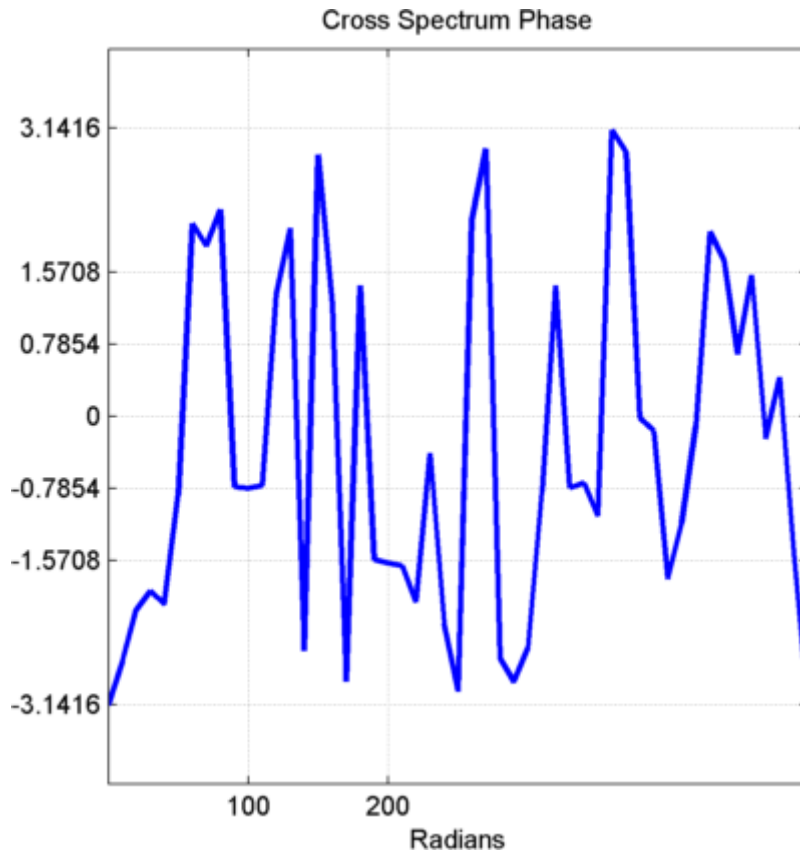

You see that at 100 Hz and 200 Hz, the phase lags estimated from the cross spectrum are close to the true values.

In this example, the cross spectrum estimates are spaced at  $1000/100=10$  Hz. You can return the phase estimates at those frequency bins. Keep in mind that the first frequency bin corresponds to 0 Hz, or DC.

```
phi100 = - angle(Cxy(11));  
phi200 = - angle(Cxy(21));
```

You see that phi100 and phi200 are close to  $-\pi/4$  and  $-\pi/2$ .

## Amplitude Estimation and Zero Padding

This example shows the effect of frequency resolution on amplitude estimation. Frequencies in the discrete Fourier transform (DFT) are spaced at intervals of  $F_s/N$  where  $F_s$  is the sampling frequency and  $N$  is the length of the input time series. Attempting to estimate the amplitude of a sinusoid with a frequency that does not correspond to a DFT *bin* can result in an inaccurate estimate. Therefore, zero padding the data before you obtain the DFT can often help to improve the amplitude estimate.

Create a signal consisting of two sine waves. The two sine waves have frequencies of 100 and 202.5 Hz. The sampling frequency is 1000 Hz and the signal is 1000 samples in length.

```
Fs = 1e3;  
t = 0:0.001:1-0.001;  
x = cos(2*pi*100*t)+sin(2*pi*202.5*t);
```

Obtain the DFT of the signal. The DFT bins are spaced at 1 Hz. Accordingly, the 100-Hz sine wave corresponds to a DFT bin, but the 202.5-Hz sine wave does not.

Because the signal is real-valued, use only the *positive* frequencies from the DFT to estimate the amplitude. Scale the DFT by the length of the input signal and multiply all frequencies except 0 and the Nyquist by 2.

Plot the result with the known amplitudes for comparison.

```
freqres = Fs/length(x);  
xdft = fft(x);  
xdft = xdft(1:length(x)/2+1);  
xdft = 1/length(x).*xdft;  
xdft(2:end-1) = 2*xdft(2:end-1);  
freq = 0:Fs/length(x):Fs/2;  
plot(freq,abs(xdft));  
xlabel('Hz'); ylabel('Amplitude');  
h = line(freq,ones(length(x)/2+1,1));  
set(h,'color',[1 0 0],'linewidth',2);
```

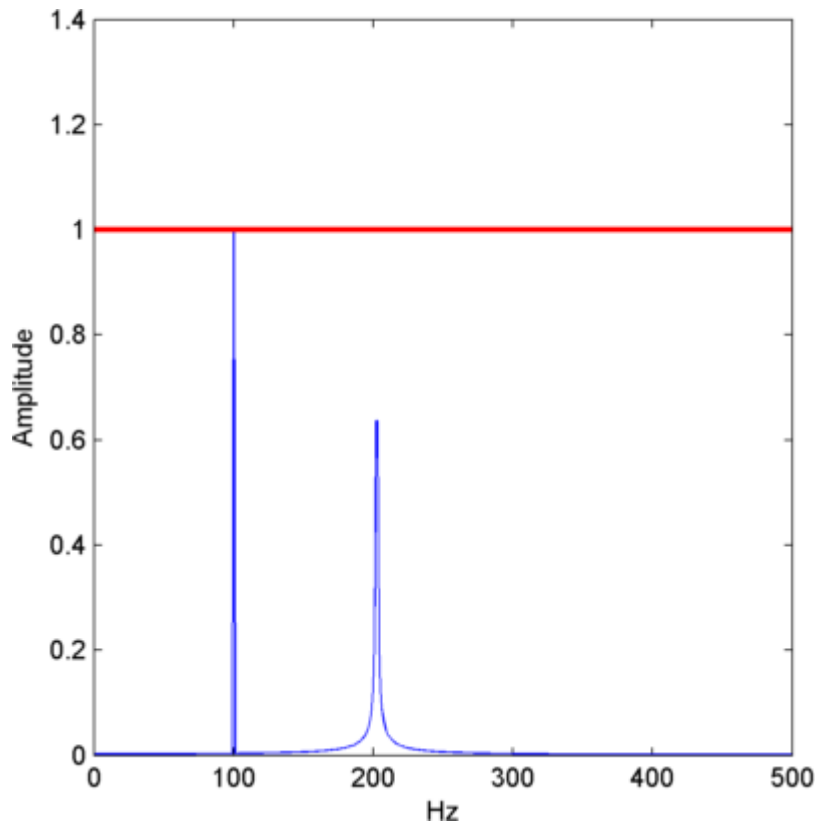

The amplitude estimate at 100 Hz is accurate because that frequency corresponds to a DFT bin. However, the amplitude estimate at 202.5 Hz is not accurate because that frequency does not correspond to a DFT bin.

You can interpolate the DFT by zero padding. While zero padding does not improve the frequency resolution of the DFT, zero padding can allow you to obtain more accurate amplitude estimates of resolvable signal components.

Pad the DFT out to length 2000. With this length, the spacing between DFT bins is  $F_s/2000=0.5$  Hz. In this case, the energy from the 202.5-Hz sine wave falls directly in a DFT bin. Using zero padding out to 2000 samples, obtain the DFT and plot the amplitude estimates.

```
xdft = fft(x,2000);
```

```
xdft = xdft(1:length(xdft)/2+1);  
xdft = 1/length(x).*xdft;  
xdft(2:end-1) = 2*xdft(2:end-1);  
freq = 0:Fs/(2*length(x)):Fs/2;  
plot(freq,abs(xdft));  
xlabel('Hz'); ylabel('Amplitude');  
h = line(freq,ones(2*length(x)/2+1,1));  
set(h,'color',[1 0 0],'linewidth',2);
```

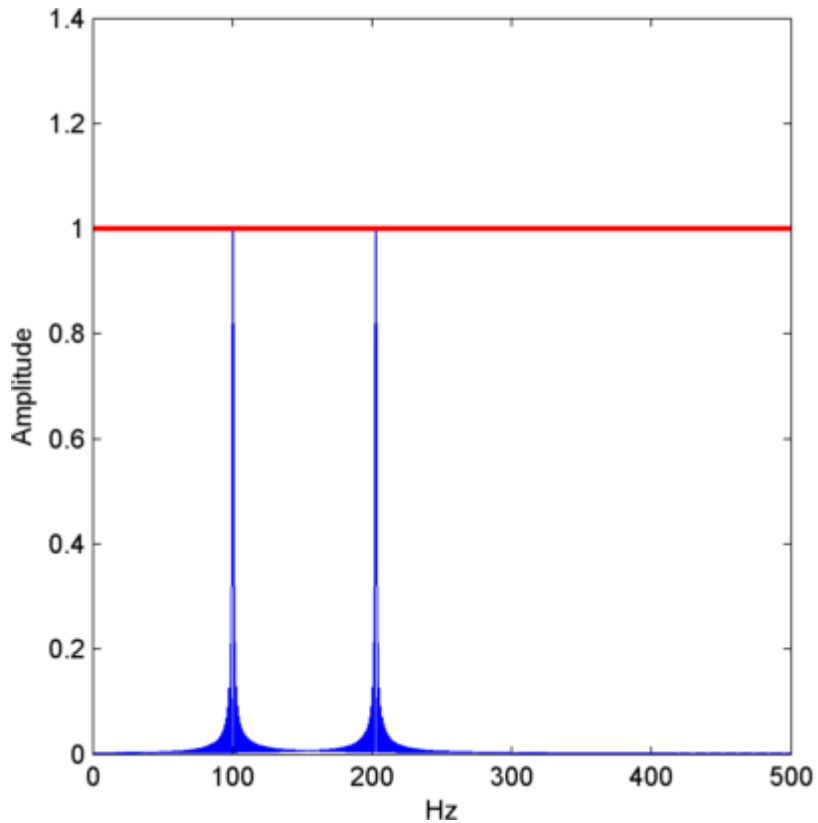

The use of zero padding enables you to estimate the amplitudes of both frequencies correctly.



## Significance Testing for Periodic Component

This example shows you how to assess the significance of a sinusoidal component in white noise using Fisher's  $g$ -statistic. Fisher's  $g$ -statistic is the ratio of the largest periodogram value to the sum of all the periodogram values over 1/2 of the frequency interval,  $(0, F_s/2)$ . A detailed description of the  $g$ -statistic and exact distribution can be found in [1] and [2].

Create a signal consisting of a 100-Hz sine wave in white Gaussian noise with zero mean and variance 1. The amplitude of the sine wave is 0.25. The sampling rate is 1 kHz. Set the random number generator to the default settings for reproducible results.

```
Fs = 1e3;
t = 0:0.001:1-0.001;
rng default;
x = 0.25*cos(2*pi*100*t)+randn(size(t));
```

Obtain the periodogram of the signal using `periodogram`. Exclude 0 and the Nyquist frequency ( $F_s/2$ ).

```
[Pxx,F] = periodogram(x,rectwin(length(x)),length(x),Fs);
Pxx = Pxx(2:length(x)/2);
```

Find the maximum value of the periodogram. Fisher's  $g$ -statistic is the ratio of the maximum periodogram value to the sum of all periodogram values.

```
[maxval,index] = max(Pxx);
fisher_g = Pxx(index)/sum(Pxx);
```

The maximum periodogram value occurs at 100 Hz, which you can verify by finding the frequency corresponding to the index of the maximum periodogram value.

```
F = F(2:end-1);
F(index)
```

Use the distributional results detailed in [1] and [2] to determine the significance level, `pval`, of Fisher's  $g$ -statistic. The following MATLAB code implements equation 6 on page 7 in [2].

```
N = length(Pxx);
```

```
upper = floor(1/fisher_g);  
for nn = 1:3  
    I(nn) = ...  
        (-1)^(nn-1)*nchoosek(N,nn)*(1-nn*fisher_g)^(N-1);  
end  
pval = sum(I);
```

The p-value is less than 0.00001, which indicates a significant periodic component at 100 Hz. The interpretation of Fisher's  $g$ -statistic is complicated by the presence of other periodicities. See [1] for a modification when multiple periodicities may be present.

## References

- [1] Percival, D.B. and Walden, A.T. *Spectral Analysis for Physical Applications*, Cambridge University Press, 1993, p. 491.
- [2] Wichert, S., Fokianos, K., and Strimmer, K. "Identifying periodically expressed transcripts in microarray time series data", *Bioinformatics*, 20, 5-20, 2004.

## Frequency Estimation by Subspace Methods

This example shows you how to resolve closely-spaced sine waves using subspace methods. Subspace methods assume a harmonic model consisting of a sum of sine waves, possibly complex, in additive noise. In a complex-valued harmonic model, the noise is also complex-valued.

Create a complex-valued signal 24 samples in length. The signal consists of two complex exponentials (sine waves) with frequencies of 0.50 and 0.52 hertz and additive complex white Gaussian noise. The noise has zero mean and variance  $0.2^2$ . In a complex white noise, both the real and imaginary parts have variance equal to  $1/2$  the overall variance.

```
n = 0:23;  
rng default  
x = exp(1j*2*pi*0.5*n)+exp(1j*2*pi*0.52*n)+ ...  
    0.2/sqrt(2)*(randn(size(n))+1j*randn(size(n)));
```

Using periodogram, attempt to resolve the two sine waves.

```
periodogram(x,rectwin(length(x)),128,1);
```

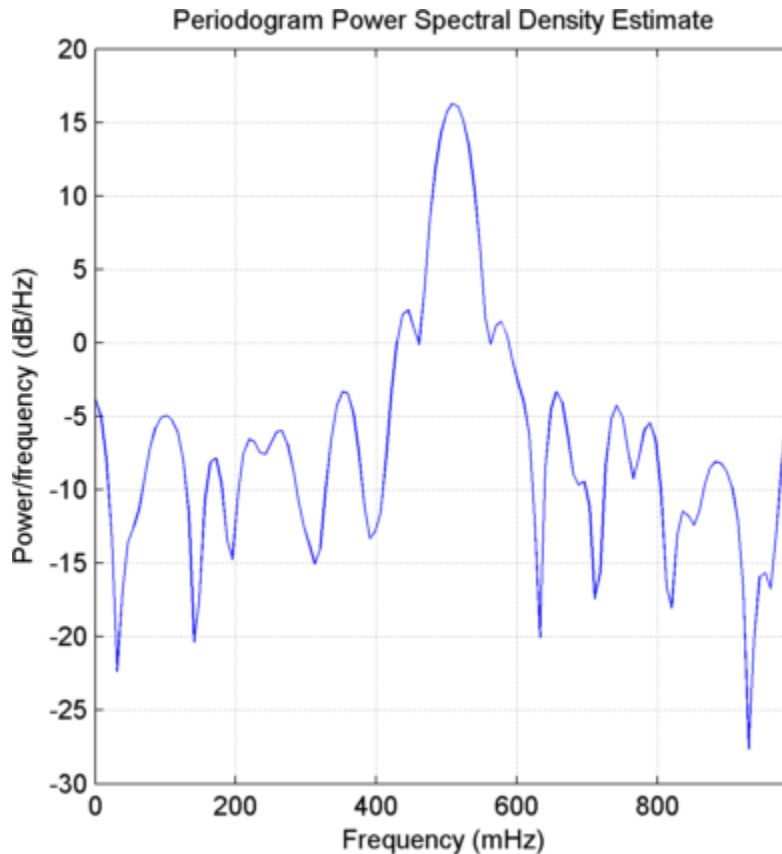

The periodogram shows a broad peak near 1/2 Hz. You cannot resolve the two separate sine waves because the frequency resolution of the periodogram is  $1/N$ , where  $N$  is the length of the signal. In this case,  $1/N$  is greater than the separation of the two sine waves. Zero padding does not help to resolve two separate peaks.

Use a subspace method to resolve the two closely-spaced peaks. In this example, use the root-MUSIC method. Estimate the autocorrelation matrix and input the autocorrelation matrix into `pmusic`. Specify a model with 2 sinusoidal components. Plot the result.

```
[X,R] = corrmatrix(x,14,'mod');
```

```
[S,F] = pmusic(R,2,[],1,'corr');  
plot(F,S,'linewidth',2); set(gca,'xlim',[0.46 0.60]);  
grid on; xlabel('Hz'); ylabel('Pseudospectrum');
```

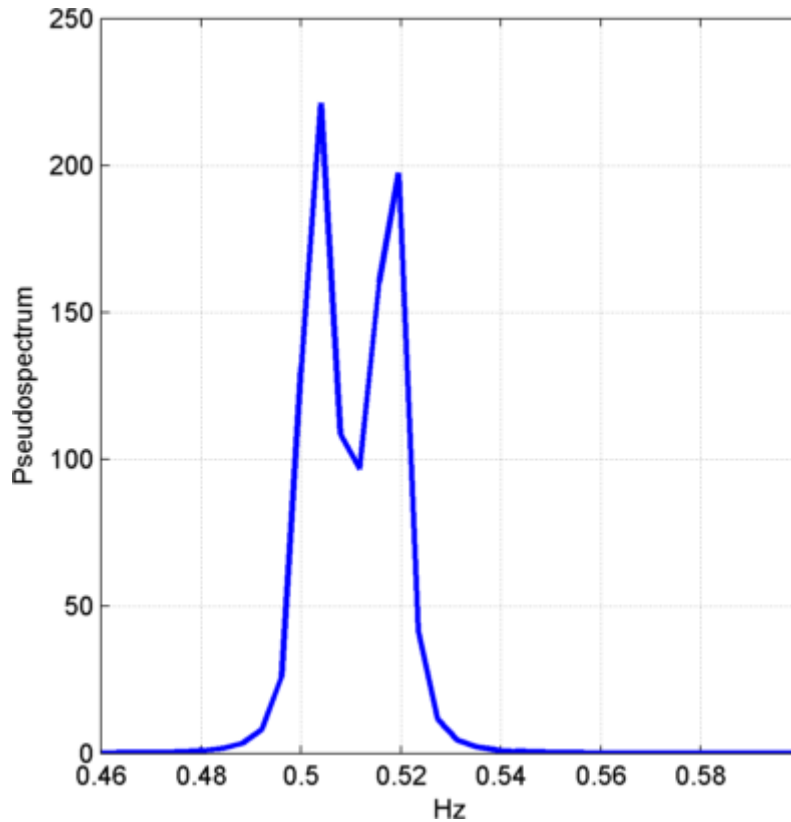

The root MUSIC method is able to separate the two peaks at 0.5 and 0.52 Hz. However, subspace methods do not produce power estimates like power spectral density estimates. Subspace methods are most useful for frequency identification and can be sensitive to model-order misspecification.

## Frequency-Domain Linear Regression

This example shows how to use the discrete Fourier transform to construct a linear regression model for a time series. The time series used in this example is the monthly number of accidental deaths in the U.S. from 1973 to 1979. The data are published in [1]. The original source is the U.S. National Safety Council.

Enter the data. Copy the `exdata` matrix into the MATLAB workspace.

```
exdata = [
    9007    7750    8162    7717    7792    7836
    8106    6981    7306    7461    6957    6892
    8928    8038    8124    7776    7726    7791
    9137    8422    7870    7925    8106    8129
    10017   8714    9387    8634    8890    9115
    10826   9512    9556    8945    9299    9434
    11317   10120   10093   10078   10625   10484
    10744   9823    9620    9179    9302    9827
    9713    8743    8285    8037    8314    9110
    9938    9129    8433    8488    8850    9070
    9161    8710    8160    7874    8265    8633
    8927    8680    8034    8647    8796    9240];
```

`exdata` is a 12-by-6 matrix. Each column of `exdata` contains 12 months of data. The first row of each column contains the number of U.S. accidental deaths for January of the corresponding year. The last row of each column contains the number of U.S. accidental deaths for December of the corresponding year.

Reshape the data matrix into a 72-by-1 time series and plot the data for the years 1973 to 1978.

```
ts = reshape(exdata,72,1);
years = linspace(1973,1979,72);
plot(years,ts,'bo-','markerfacecolor',[0 0 1]); xlabel('Year');
ylabel('Number of Accidental Deaths'); grid on;
```

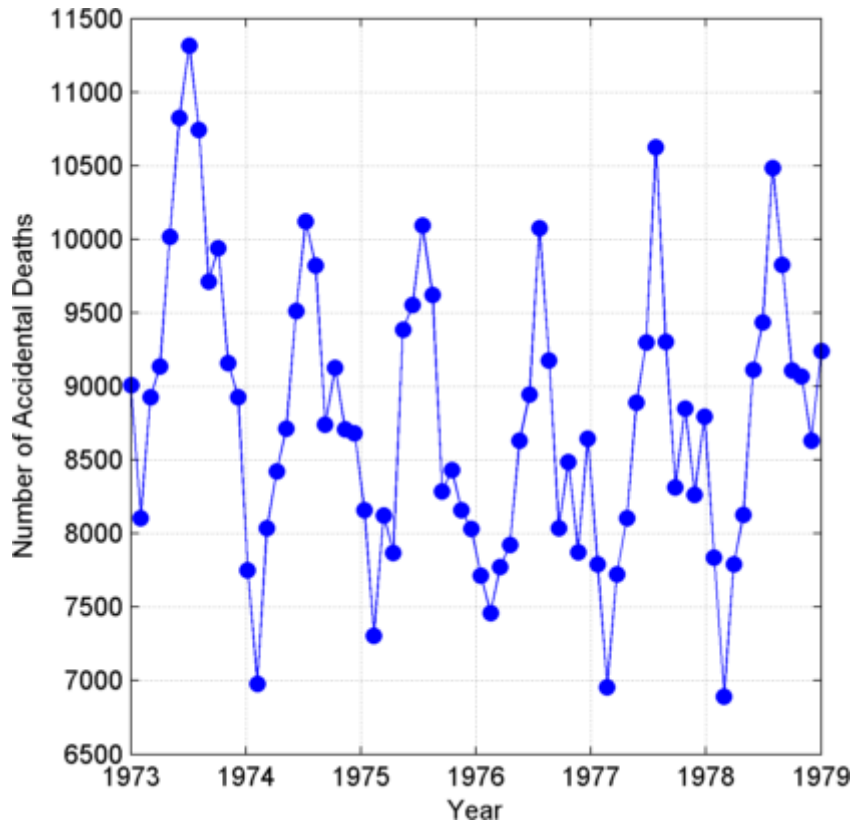

A visual inspection of the data indicates that number of accidental deaths varies in a periodic manner. The period of the oscillation appears to be roughly 1 year (12 months). The periodic nature of the data suggests that an appropriate model may be

$$X(n) = \mu + \sum_k A_k \cos\left(\frac{2\pi kn}{N}\right) + B_k \sin\left(\frac{2\pi kn}{N}\right) + \varepsilon(n)$$

where  $\mu$  is the overall mean,  $N$  is the length of the time series, and  $\varepsilon(n)$  is a white noise sequence of independent and identically-distributed (iid) Gaussian random variables with zero mean and some variance. The additive noise term accounts for the randomness inherent in the data. The parameters

of the model are the overall mean and the amplitudes of the cosines and sines. The model is linear in the parameters.

To construct a linear regression model in the time domain, you have to specify which frequencies to use for the cosines and sines, form the design matrix, and solve the normal equations in order to obtain the least-squares estimates of the model parameters. In this case, it is easier to use the discrete Fourier transform to detect the periodicities, retain only a subset of the Fourier coefficients, and invert the transform to obtain the fitted time series.

Perform a spectral analysis of the data to reveal which frequencies contribute significantly to the variability in the data. Because the overall mean of the signal is approximately 9,000 and is proportional to the Fourier transform at 0 frequency, subtract the mean prior to the spectral analysis. This reduces the large magnitude Fourier coefficient at 0 frequency and makes any significant oscillations easier to detect. The frequencies in the Fourier transform are spaced at an interval that is the reciprocal of the time series length,  $1/72$ . Sampling the data monthly, the highest frequency in the spectral analysis is 1 cycle/2 months. In this case, it is convenient to look at the spectral analysis in terms of cycles/year so scale the frequencies accordingly for visualization.

```
tsdft = fft(ts-mean(ts));  
freq = 0:1/72:1/2;  
plot(freq.*12,abs(tsdft(1:length(ts)/2+1)), 'bo-', 'markerfacecolor',[0 0 1])  
xlabel('Cycles/Year'); ylabel('Magnitude');  
set(gca,'xtick', [1/6 1 2 3 4 5 6])
```



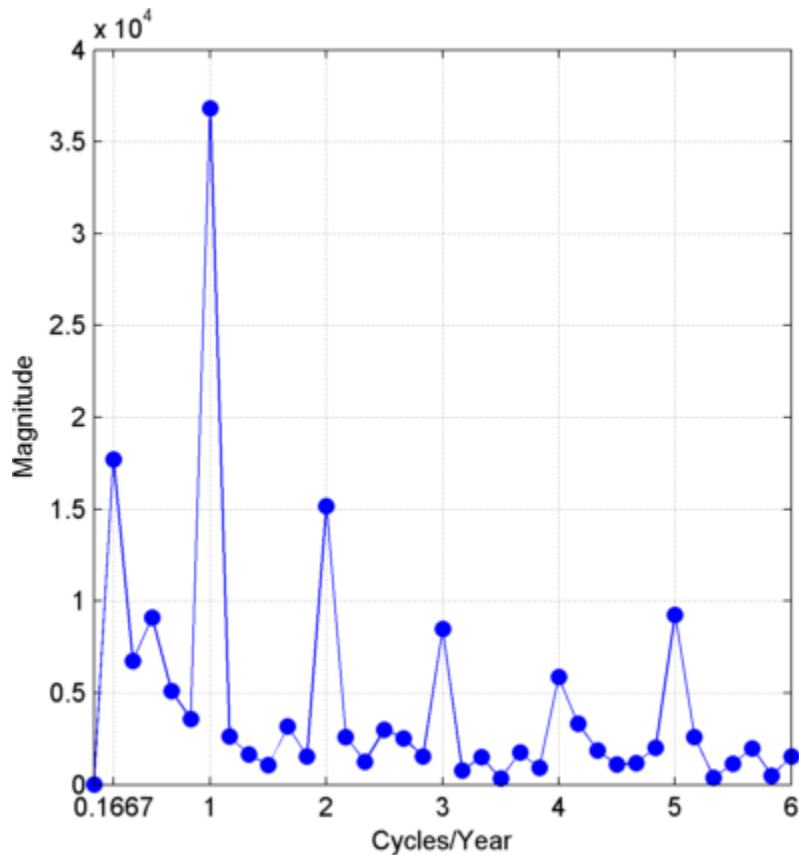

Based on the magnitudes, the frequency of 1 cycle/12 months is the most significant oscillation in the data. The magnitude at 1 cycle/12 months is more than twice as large as any other magnitude. However, the spectral analysis reveals that there are also other periodic components in the data. For example, there appears to be periodic components at harmonics (integer multiples) of 1 cycle/12 months. There also appears to be a periodic component with a period of 1 cycle/72 months.

Based on the spectral analysis of the data, fit a simple linear regression model using a cosine and sine term with a frequency of the most significant component: 1 cycle/year (1 cycle/12 months).

Determine the frequency bin in the discrete Fourier transform that corresponds to 1 cycle/12 months. Because the frequencies are spaced at  $1/72$  and the first bin corresponds to 0 frequency, the correct bin is  $72/12+1$ . This is the frequency bin of the *positive* frequency. You must also include the frequency bin corresponding to the *negative* frequency:  $-1$  cycle/12 months. With MATLAB indexing, the frequency bin of the negative frequency is  $72-72/12+3$ .

Create a 72-by-1 vector of zeros. Fill the appropriate elements of the vector with the Fourier coefficients corresponding to a positive and negative frequency of 1 cycle/12 months. Invert the Fourier transform and add the overall mean to obtain a fit to the accidental death data.

```
N = 72;
freqbin = N/12+1;
freqbins = [freqbin N-freqbin+2];
tsfit = zeros(72,1);
tsfit(freqbins) = tsdft(freqbins);
tsfit = ifft(tsfit,'symmetric');
mu = mean(ts);
tsfit = mu+tsfit;
```

Plot the original data along with the fitted series using two Fourier coefficients.

```
plot(years,ts,'bo-','markerfacecolor',[0 0 1]); xlabel('Year');
ylabel('Number of Accidental Deaths'); grid on;
hold on;
plot(years,tsfit,'r','linewidth',2);
legend('Data','Fitted Model');
```

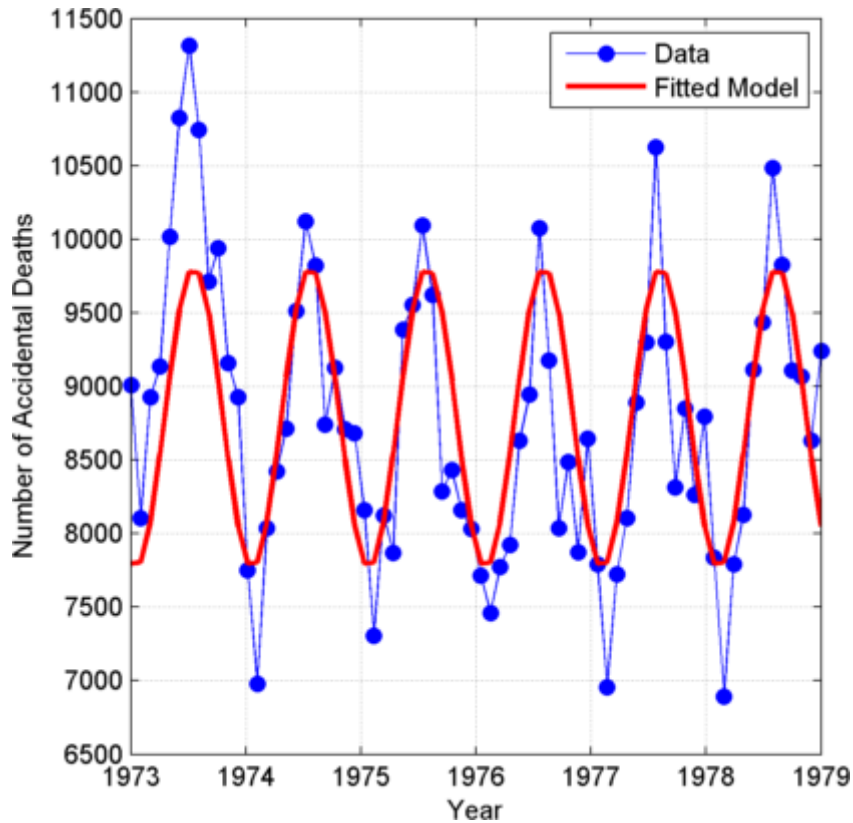

The fitted model appears to capture the general periodic nature of the data and supports the initial conclusion that data oscillate with a cycle of 1 year.

To assess how adequately the single frequency of 1 cycle/12 months accounts for the observed time series, form the residuals. If the residuals resemble a white noise sequence, the simple linear model with one frequency has adequately modeled the time series.

To assess the residuals, use the autocorrelation sequence with 95%-confidence intervals for a white noise. See “Confidence Intervals for Sample Autocorrelation” on page 10-5 for a detailed example on how to form the 95%-confidence intervals.

```
resid = ts-tsfit;
```

```
[xc,lags] = xcorr(resid,50,'coeff');
stem(lags(51:end),xc(51:end),'markerfacecolor',[0 0 1]);
hold on;
lconf = -1.96*ones(51,1)/sqrt(72);
uconf = 1.96*ones(51,1)/sqrt(72);
plot(lags(51:end),lconf,'r','linewidth',2);
plot(lags(51:end),uconf,'r','linewidth',2);
xlabel('Lag'); ylabel('Correlation Coefficient');
title('Autocorrelation of Residuals');
```

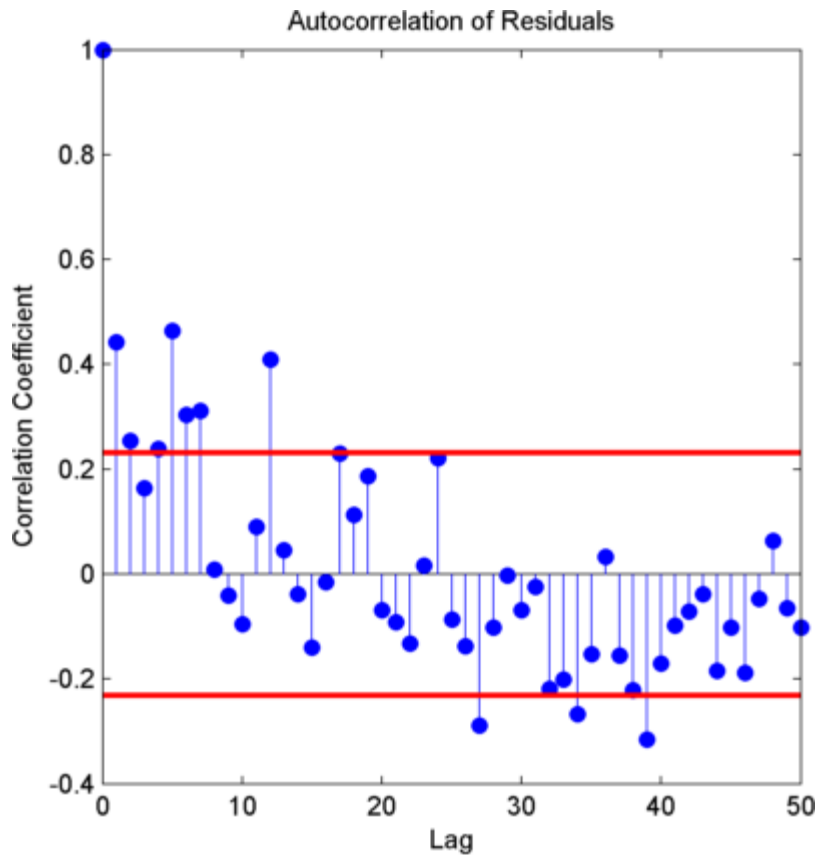

The autocorrelation values fall outside the 95% confidence bounds at a number of lags. It does not appear that the residuals are white noise. The

conclusion is that the simple linear model with one sinusoidal component does not account for all the oscillations in the number of accidental deaths. This is expected because the spectral analysis revealed additional periodic components in addition to the dominant oscillation. Creating a model that incorporates additional periodic terms indicated by the spectral analysis will improve the fit and whiten the residuals.

Fit a model which consists of the three largest Fourier coefficient magnitudes. Because you have to retain the Fourier coefficients corresponding to both negative and positive frequencies, retain the largest 6 indices.

```
tsfit2dft = zeros(72,1);
[Y,I] = sort(abs(tsdft),'descend');
indices = I(1:6);
tsfit2dft(indices) = tsdft(indices);
```

Demonstrate that preserving only 6 of the 72 Fourier coefficients (3 frequencies) retains most of the signal's energy. First, demonstrate that retaining all the Fourier coefficients yields energy equivalence between the original signal and the Fourier transform.

```
norm(1/sqrt(72)*tsdft,2)/norm(ts-mean(ts),2)
```

The ratio is 1. Now, examine the energy ratio where only 3 frequencies are retained.

```
norm(1/sqrt(72)*tsfit2dft,2)/norm(ts-mean(ts),2)
```

Almost 90% of the energy is retained. Equivalently, 90% of the variance of the time series is accounted for by 3 frequency components.

Form an estimate of the data based on 3 frequency components. Compare the original data, the model with one frequency, and the model with 3 frequencies.

```
tsfit2 = mu+ifft(tsfit2dft,'symmetric');
plot(years,ts,'bo-','markerfacecolor',[0 0 1]); xlabel('Year');
ylabel('Number of Accidental Deaths'); grid on;
hold on;
plot(years,tsfit,'r','linewidth',2);
plot(years,tsfit2,'k','linewidth',2);
legend('Data','1 Frequency','3 Frequencies');
```

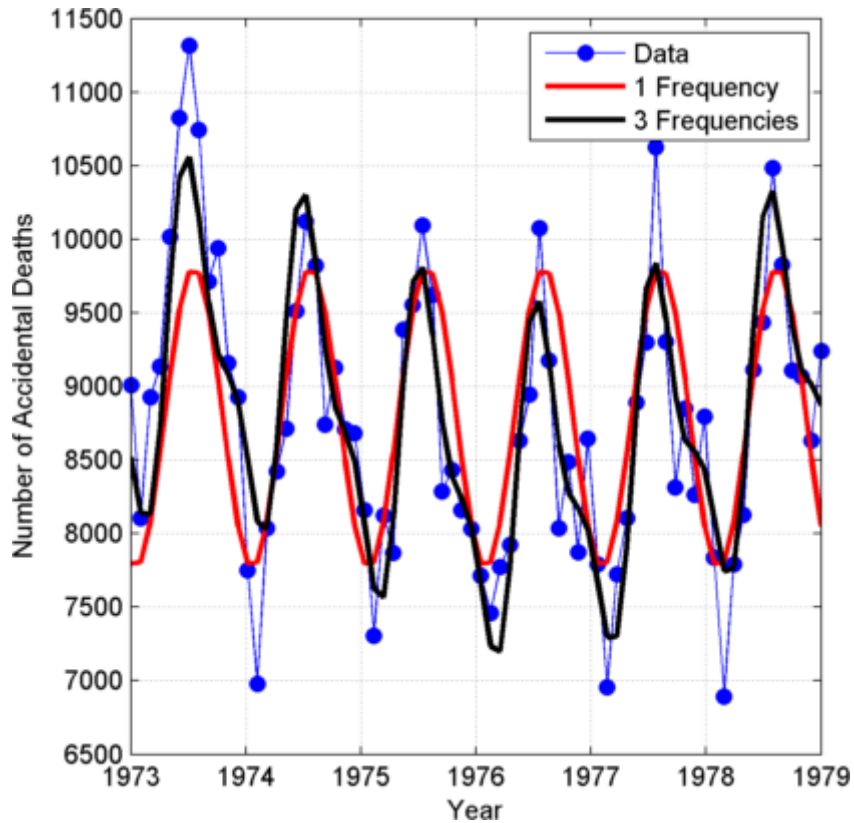

Using 3 frequencies has improved the fit to the original signal. You can see this by examining the autocorrelation of the residuals from the 3-frequency model.

```
resid = ts-tsfit2;
[xc,lags] = xcorr(resid,50,'coeff');
stem(lags(51:end),xc(51:end),'markerfacecolor',[0 0 1]);
hold on;
lconf = -1.96*ones(51,1)/sqrt(72);
uconf = 1.96*ones(51,1)/sqrt(72);
plot(lags(51:end),lconf,'r','linewidth',2);
plot(lags(51:end),uconf,'r','linewidth',2);
xlabel('Lag'); ylabel('Correlation Coefficient');
title('Autocorrelation of Residuals');
```

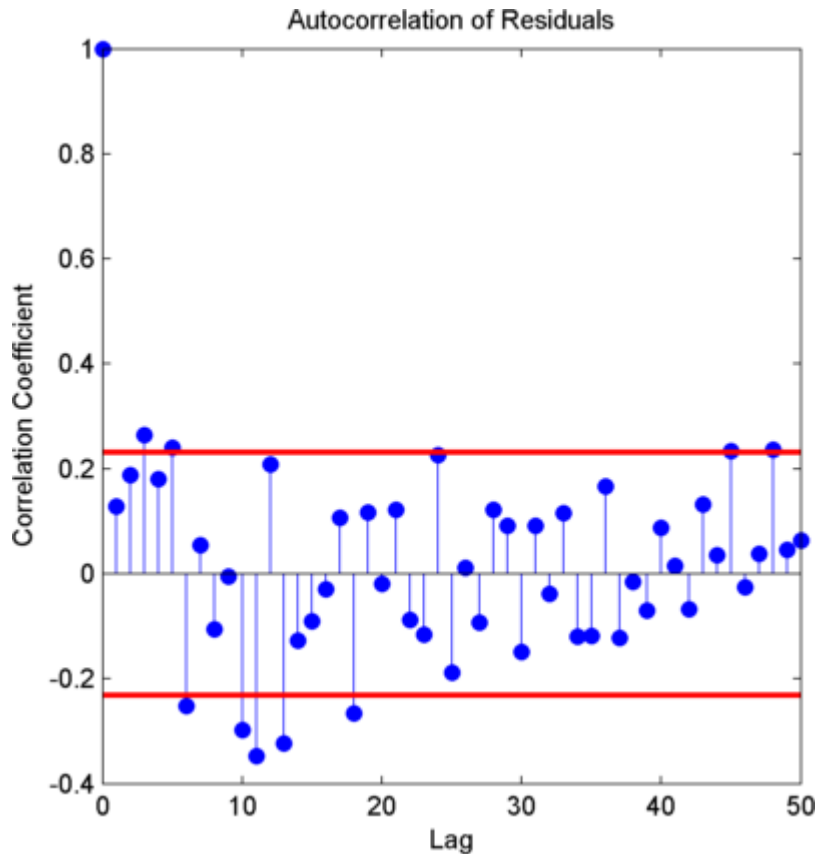

Using 3 frequencies has resulted in residuals that more closely approximate a white noise process.

Demonstrate that the parameter values obtained from the Fourier transform are equivalent to a time-domain linear regression model. Find the least-squares estimates for the overall mean, the cosine amplitudes, and the sine amplitudes for the 3 frequencies by forming the design matrix and solving the normal equations. Compare the fitted time series with that obtained from the Fourier transform.

```
X = ones(72,7);
X(:,2) = cos(2*pi/72*(0:71))';
```

```
X(:,3) = sin(2*pi/72*(0:71))';  
X(:,4) = cos(2*pi*6/72*(0:71))';  
X(:,5) = sin(2*pi*6/72*(0:71))';  
X(:,6) = cos(2*pi*12/72*(0:71))';  
X(:,7) = sin(2*pi*12/72*(0:71))';  
beta = X\ts;  
tsfit_lm = X*beta;  
max(abs(tsfit_lm-tsfit2))
```

The two methods yield identical results. The maximum absolute value of the difference between the two waveforms is on the order of  $10^{-12}$ . In this case, the frequency-domain approach was easier than the equivalent time-domain approach. You naturally use a spectral analysis to visually inspect which oscillations are present in the data. From that step, it is simple to use the Fourier coefficients to construct a model for the signal consisting of a sum cosines and sines.

For more details on spectral analysis in time series and the equivalence with time-domain regression see [2].

While spectral analysis can answer which periodic components contribute significantly to the variability of the data, it does not explain why those components are present. If you examine these data closely, you see that the minimum values in the 12-month cycle tend to occur in February, while the maximum values occur in July. A plausible explanation for these data is that people are naturally more active in summer than in the winter. Unfortunately, as a result of this increased activity, there is an increased probability of the occurrence of fatal accidents.

## References

- [1] Brockwell, P.J and Davis, R.A. *Time Series: Theory and Methods*, Springer, 2006.
- [2] Shumway, R.H. and Stoffer, D.S. *Time Series Analysis and Its Applications with R Examples*, Springer, 2006.



# Linear Prediction

---

- “Prediction Polynomial” on page 13-2
- “Formant Estimation with LPC Coefficients” on page 13-5
- “AR Order Selection with Partial Autocorrelation Sequence” on page 13-9

## Prediction Polynomial

This example shows how to obtain the prediction polynomial from an autocorrelation sequence. The example also shows that the resulting prediction polynomial has an inverse that produces a stable all-pole filter. You can use the all-pole filter to filter a wide-sense stationary white noise sequence to produce a wide-sense stationary autoregressive process.

Create an autocorrelation sequence defined by

$$r(k) = (24/5)2^{-|k|} - (27/10)3^{-|k|} \quad k = 0, 1, 2$$

```
k = 0:2;
```

```
rk = (24/5)*2.^(-k) - (27/10)*3.^(-k);
```

Use `ac2poly` to obtain the prediction polynomial of order 2.

```
A = ac2poly(rk);
```

The prediction polynomial of order 2 is

$$A(z) = 1 - 5/6z^{-1} + 1/6z^{-2}$$

Examine the pole-zero plot of the FIR filter to see that the zeros are inside the unit circle.

```
zplane(A, 1)
```

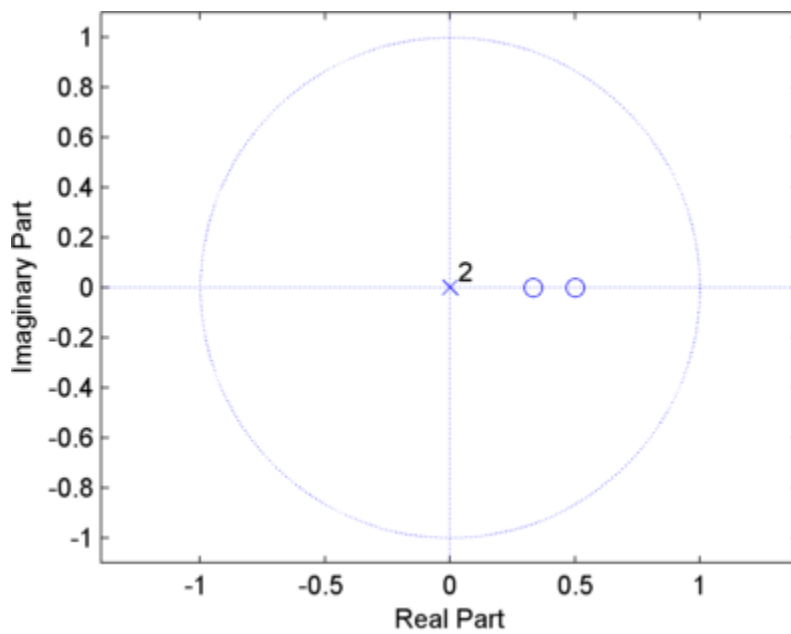

The inverse all-pole filter is stable with poles inside the unit circle.

`zplane(1,A)`

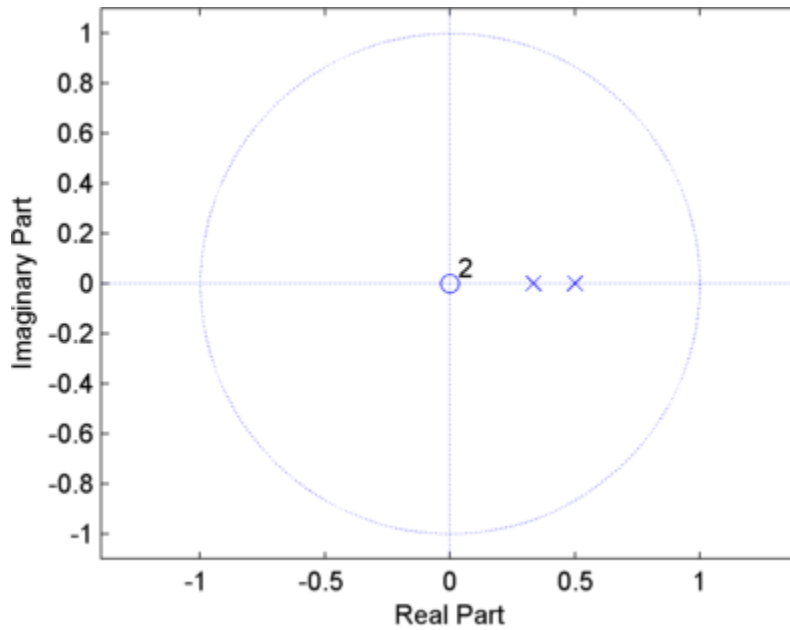

Use the all-pole filter to produce a realization of a wide-sense stationary AR(2) process from a white noise sequence. Set the random number generator to the default settings for reproducible results.

```
rng default;
x = randn(1000,1);
y = filter(1,A,x);
```

Compute the sample autocorrelation of the AR(2) realization and show that the sample autocorrelation is close to the true autocorrelation.

```
[xc,lags] = xcorr(y,2,'biased');
[xc(3:end) rk']
```

Estimated Autocorrelation Sequence Values	True Autocorrelation Sequence Values
2.24	2.1
1.64	1.5
0.99	0.90

## Formant Estimation with LPC Coefficients

This example shows you how to estimate vowel formant frequencies using linear predictive coding (LPC). The formant frequencies are obtained by finding the roots of the prediction polynomial.

The example “Complex Cepstrum — Fundamental Frequency Estimation” on page 14-2 uses the same speech signal to estimate the fundamental frequency.

---

**Note** This example uses the speech sample `mt1b.mat`, which is part of Signal Processing Toolbox. The speech is lowpass-filtered. Because of the low sampling frequency, this speech sample is not optimal for this example. The low sampling frequency limits the order of the autoregressive model you can fit to the data. In spite of this limitation, the example illustrates the technique for using LPC coefficients to determine vowel formants.

---

Load the speech signal. The recording is a woman saying “MATLAB”. The sampling frequency is 7418 Hz.

```
load mt1b;
```

The MAT file contains the speech waveform, `mt1b`, and the sampling frequency, `Fs`.

Use the spectrogram to identify a voiced segment for analysis.

```
segmentlen = 100;  
noverlap = 90;  
NFFT = 128;  
[y,f,t,p] = spectrogram(mt1b,segmentlen,noverlap,NFFT,Fs);  
surf(t,f,10*log10(abs(p)),'EdgeColor','none');  
axis xy; axis tight; colormap(jet); view(0,90);  
xlabel('Time');  
ylabel('Frequency (Hz)');
```

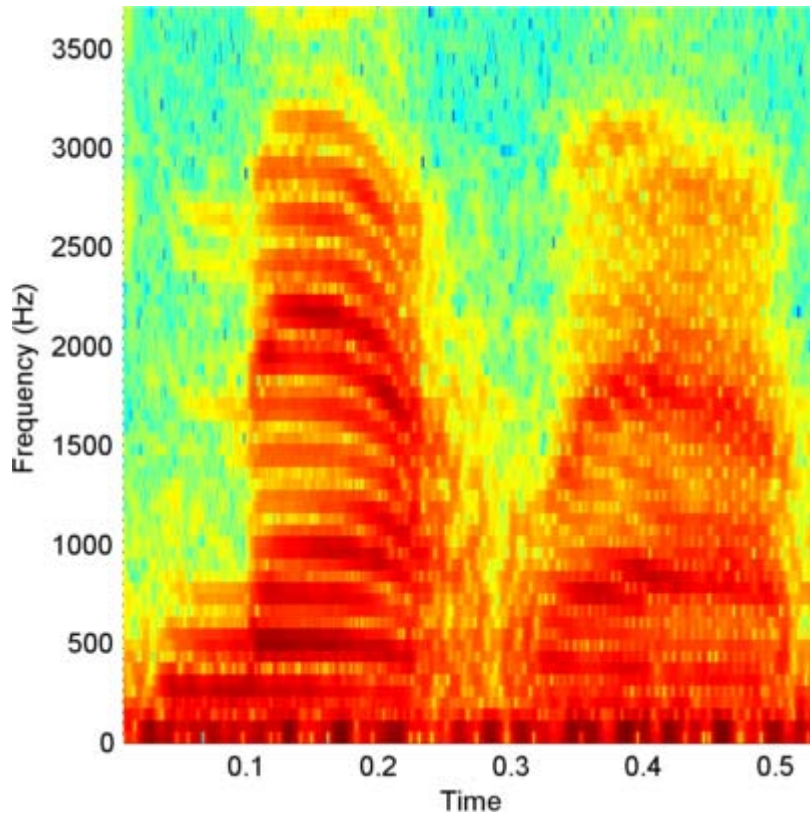

Extract the segment from 0.1 to 0.25 seconds for analysis. The extracted segment corresponds roughly to the first vowel, /ae/, in “MATLAB”.

```
dt = 1/Fs;  
I0 = round(0.1/dt);  
Iend = round(0.25/dt);  
x = mtlb(I0:Iend);
```

Two common preprocessing steps applied to speech waveforms before linear predictive coding are windowing and pre-emphasis (highpass) filtering.

Window the speech segment using a Hamming window.

```
x1 = x.*hamming(length(x));
```

Apply a pre-emphasis filter. The pre-emphasis filter is a highpass all-pole (AR(1)) filter.

```
preemph = [1 0.63];
x1 = filter(1,preemph,x1);
```

Obtain the linear prediction coefficients. To specify the model order, use the general rule that the order is two times the expected number of formants plus 2. In the frequency range,  $[0, F_s/2]$ , you expect 3 formants. Therefore, set the model order equal to 8. Find the roots of the prediction polynomial returned by `lpc`.

```
A = lpc(x1,8);
rts = roots(A);
```

Because the LPC coefficients are real-valued, the roots occur in complex conjugate pairs. Retain only the roots with one sign for the imaginary part and determine the angles corresponding to the roots.

```
rts = rts(imag(rts)>=0);
angz = atan2(imag(rts),real(rts));
```

Convert the angular frequencies in radians/sample represented by the angles to hertz and calculate the bandwidths of the formants [1].

The bandwidths of the formants are represented by the distance of the prediction polynomial zeros from the unit circle.

```
[frqs,indices] = sort(angz.*(Fs/(2*pi)));
bw = -1/2*(Fs/(2*pi))*log(abs(rts(indices)));
```

Use the criteria that formant frequencies should be greater than 90 Hz with bandwidths less than 400 Hz to determine the formants [2].

```
nn = 1;
for kk = 1:length(frqs)
    if (frqs(kk) > 90 && bw(kk) <400)
        formants(nn) = frqs(kk);
        nn = nn+1;
    end
end
formants
```

The first three formants are 869.70, 2026.49, and 2737.95 Hz.

## References

- [1] Snell, R. “Formant location from LPC analysis data”, *IEEE® Transactions on Speech and Audio Processing*, 1(2), pp. 129–134, 1993.
- [2] Loizou, P. “COLEA: a MATLAB software tool for speech analysis”.



## AR Order Selection with Partial Autocorrelation Sequence

This example shows how to assess the order of an autoregressive model using the partial autocorrelation sequence. For a moving average process, you can use the autocorrelation sequence to assess the order. However, for an autoregressive (AR) or autoregressive moving average (ARMA) process, the autocorrelation sequence does not help in order selection.

For these processes, you can use the partial autocorrelation sequence to help with model order selection. For a stationary time series with values  $X(1), X(2), X(3), \dots, X(k+1)$ , the partial autocorrelation sequence at lag  $k$  is the correlation between  $X(1)$  and  $X(k+1)$  after regressing  $X(1)$  and  $X(k+1)$  on the intervening observations  $X(2), X(3), X(4), \dots, X(k)$ .

Consider the AR(2) process defined by

$$X(n) + 1.5X(n-1) + 0.75X(n-2) = \varepsilon(n)$$

where  $\varepsilon(n)$  is an  $N(0,1)$  Gaussian white noise process. The following example

- simulates a realization of the AR(2) process
- graphically explores the correlation between lagged values of the time series
- examines the sample autocorrelation sequence of the time series
- fits an AR(15) model to the time series by solving the Yule-Walker equations (`aryule`)
- uses the reflection coefficients returned by `aryule` to compute the partial autocorrelation sequence
- examines the partial autocorrelation sequence to select the model order

Simulate a time series 1,000 samples in length from the AR(2) process defined by the difference equation. Set the random number generator to the default settings for reproducible results.

```
A = [1 1.5 0.75];
rng default
x = filter(1,A,randn(1000,1));
```

View the frequency response of the AR(2) process.

```
[H,W] = freqz(1,A);  
plot(W,20*log10(abs(H)), 'linewidth',2); grid on;  
axis tight;  
xlabel('Radians/sample'); ylabel('dB');
```

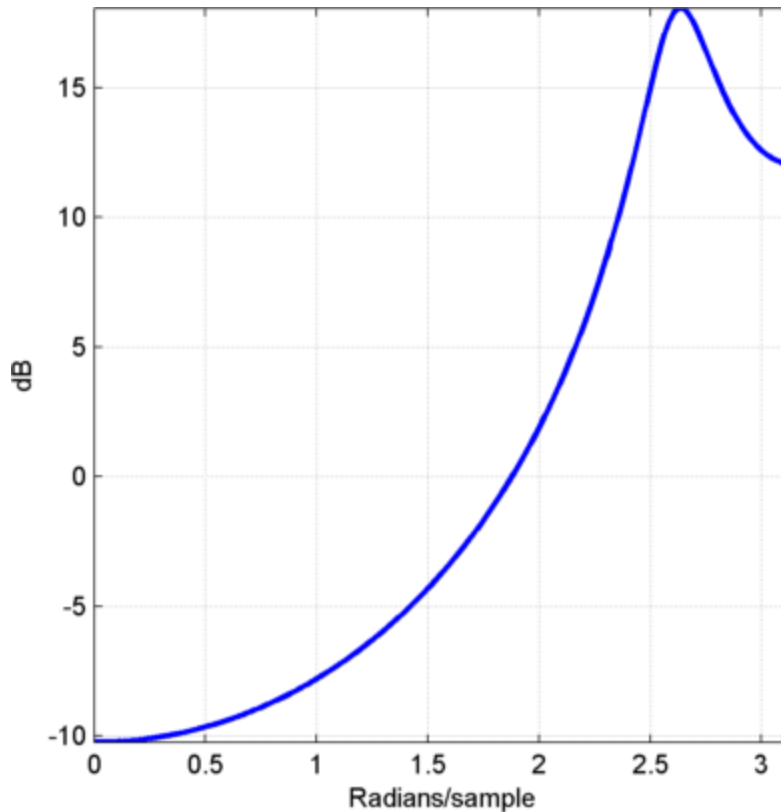

The AR(2) process acts like a highpass filter in this case.

Graphically examine the correlation in  $x$  by producing scatter plots of  $X(1)$  vs  $X(n)$  for  $n=2,3,4,5$ .

```
x12 = x(1:end-1);  
x21 = x(2:end);  
x13 = x(1:end-2);  
x31 = x(3:end);
```

```
x14 = x(1:end-3);
x41 = x(4:end);
x15 = x(1:end-4);
x51 = x(5:end);
subplot(2,2,1)
plot(x12,x21,'b*');
xlabel('X_1'); ylabel('X_2');
subplot(2,2,2)
plot(x13,x31,'b*');
xlabel('X_1'); ylabel('X_3');
subplot(2,2,3)
plot(x14,x41,'b*');
xlabel('X_1'); ylabel('X_4');
subplot(2,2,4)
plot(x15,x51,'b*');
xlabel('X_1'); ylabel('X_5');
```

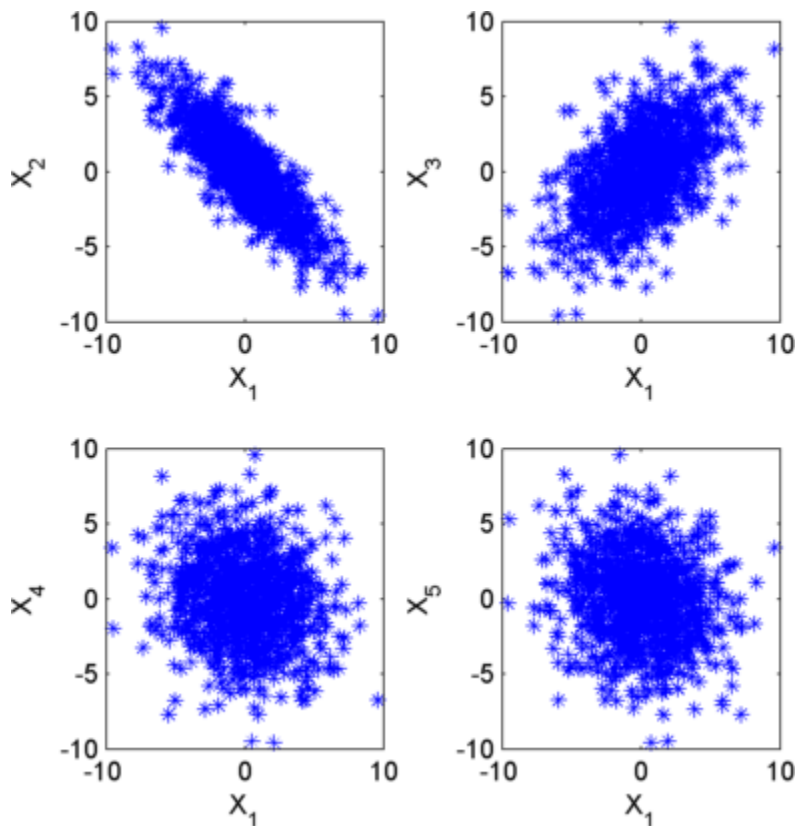

In the scatter plot, you see there is a linear relationship between  $X(1), X(2)$  and  $X(1), X(3)$ , but not between  $X(1)$  and  $X(4)$  or  $X(5)$ .

The points in the top row scatter plots fall approximately on a line with a negative slope in the top left panel and positive slope in the top right panel. The scatter plots in the bottom two panels do not show any apparent linear relationship.

The negative correlation between  $X(1)$  and  $X(2)$  and positive correlation between  $X(1)$  and  $X(3)$  are explained by the fact that the AR(2) process in this example acts like a highpass filter.

Find the sample autocorrelation sequence out to lag 50 and plot the result.

```
[xc,lags] = xcorr(x,50,'coeff');
stem(lags(51:end),xc(51:end),'markerfacecolor',[0 0 1])
xlabel('Lag'); ylabel('ACF');
title('Sample Autocorrelation Sequence');
```

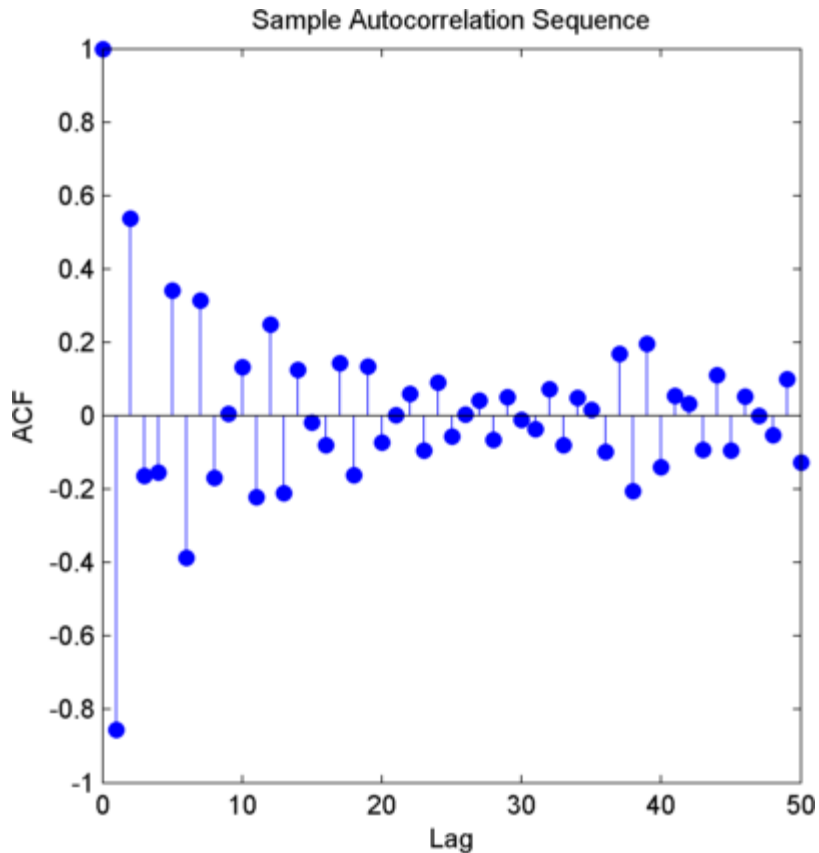

The sample autocorrelation sequence shows a negative value at lag 1 and positive value at lag 2. Based on the scatter plot, this is the expected result. However, you cannot determine from the sample autocorrelation sequence what order is appropriate for the AR model.

Fit an AR(15) model using `aryule`. Return the reflection coefficients. The negative of the reflection coefficients is the partial autocorrelation sequence.

```
[arcoef, E, K] = aryule(x, 15);
```

Plot the partial autocorrelation sequence along with the large-sample 95% confidence intervals. If the data are generated by an autoregressive process of order  $p$ , the values of the sample partial autocorrelation sequence for lags greater than  $p$  follow a  $N(0, 1/N)$  distribution where  $N$  is the length of the time series. The example “Confidence Intervals for Sample Autocorrelation” on page 10-5 shows you how to form the 95% confidence intervals for the  $N(0, 1/N)$  distributions.

```
pacf = -K;
lag = 1:15;
stem(lag, pacf, 'markerfacecolor', [0 0 1]);
xlabel('Lag'); ylabel('Partial Autocorrelation');
set(gca, 'xtick', 1:1:15)
lconf = -1.96/sqrt(1000)*ones(length(lag), 1);
uconf = 1.96/sqrt(1000)*ones(length(lag), 1);
hold on;
line(lag, lconf, 'color', [1 0 0]);
line(lag, uconf, 'color', [1 0 0]);
```

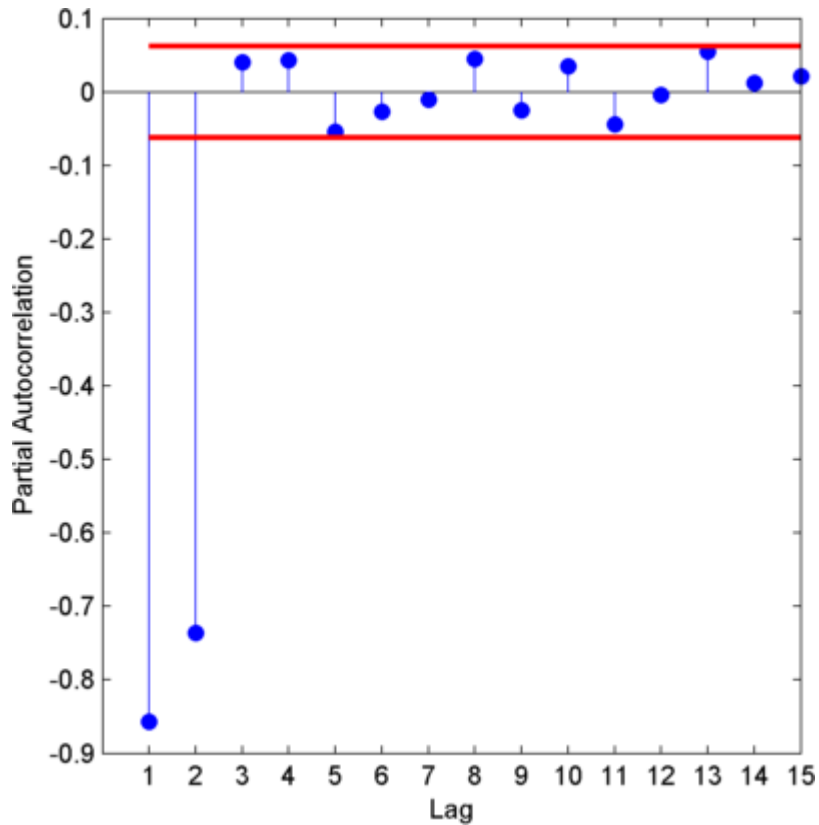

The only values of the partial autocorrelation sequence outside the 95% confidence bounds occur at lags 1 and 2. This indicates that the correct model order for the AR process is 2. In this example, you generated the time series to simulate an AR(2) process, so the partial autocorrelation sequence only confirms the result. In practice, you have only the observed time series without any a priori information about model order. In a realistic scenario, the partial autocorrelation is an important tool for appropriate model order selection in stationary autoregressive time series.





# Transforms

---

- “Complex Cepstrum — Fundamental Frequency Estimation ” on page 14-2
- “Analytic Signal for Cosine” on page 14-6
- “Envelope Extraction Using The Analytic Signal” on page 14-9

## Complex Cepstrum – Fundamental Frequency Estimation

This example shows you how to estimate a speaker's fundamental frequency using the complex cepstrum. The example also estimates the fundamental frequency using a zero-crossing method and compares the results.

Load the speech signal. The recording is a woman saying "MATLAB". The sampling frequency is 7418 Hz.

```
load mtlb;
```

The preceding code loads the speech waveform, `mtlb`, and the sampling frequency, `Fs`, in the MATLAB workspace.

Use the spectrogram to identify a voiced segment for analysis.

```
segmentlen = 100;  
noverlap = 90;  
NFFT = 128;  
[y,f,t,p] = spectrogram(mtlb,segmentlen,noverlap,NFFT,Fs);  
surf(t,f,10*log10(abs(p)),'EdgeColor','none');  
axis xy; axis tight; colormap(jet); view(0,90);  
xlabel('Time');  
ylabel('Frequency (Hz)');
```

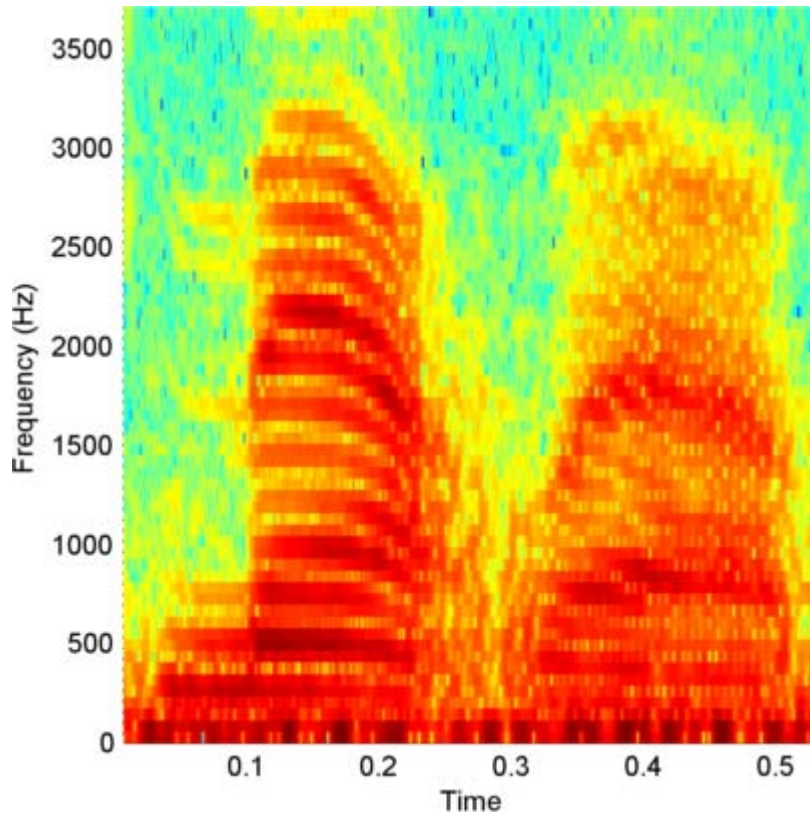

Extract the segment from 0.1 to 0.25 seconds for analysis. The extracted segment corresponds roughly to the first vowel, /ae/, in “MATLAB”.

```
dt = 1/Fs;
I0 = round(0.1/dt);
Iend = round(0.25/dt);
x = mtlb(I0:Iend);
```

Obtain the complex cepstrum.

```
c = cceps(x);
```

Plot the cepstrum for times ranging from 2 to 10 msec corresponding to a frequency range of approximately 100 to 500 Hz. Identify the peak in the

cepstrum and find the frequency corresponding to the peak. Use the peak as the estimate of the fundamental frequency.

```
t = 0:dt:length(x)-dt;
plot(t(15:75).*1e3,c(15:75)); xlabel('msec');
[~,I] = max(c(15:55));
fprintf('Complex cepstrum F0 estimate is %3.2f Hz.\n', 1/(t(I+15)));
```

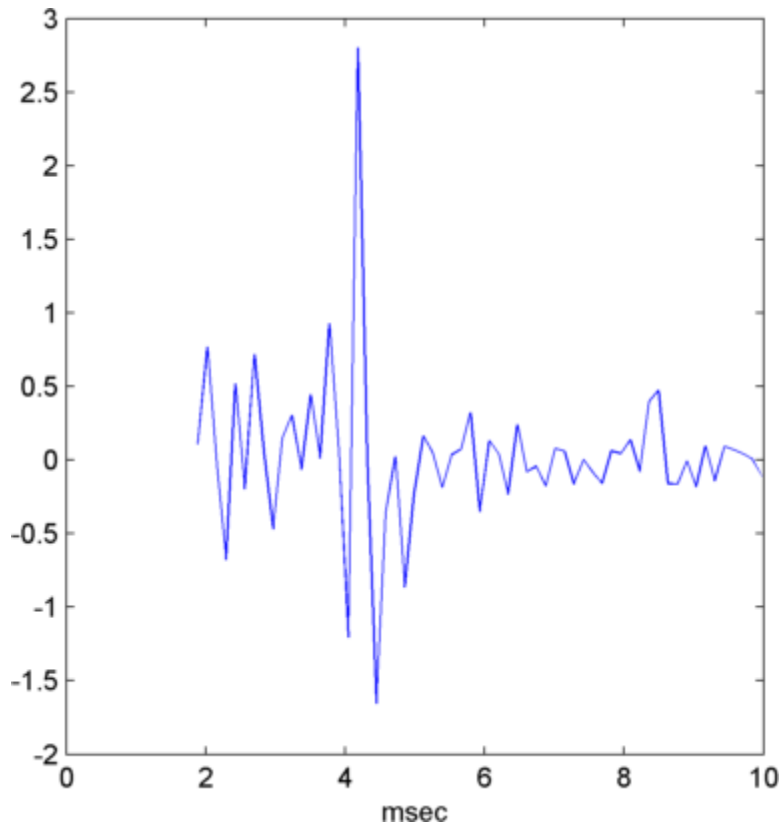

Use a zero-crossing detector on a lowpass-filtered and rectified form of the vowel to estimate the fundamental frequency.

```
[b0,a0]=butter(2,325/(Fs/2));
xin = abs(x);
xin=filter(b0,a0,xin);
```

```
xin = xin-mean(xin);  
x2=zeros(length(xin),1);  
x2(1:length(x)-1)=xin(2:length(x));  
zc=length(find((xin>0 & x2<0) | (xin<0 & x2>0)));  
F0=0.5*Fs*zc/length(x);  
fprintf('Zero-crossing F0 estimate is %3.2f Hz.\n',F0);
```

The estimate of the fundamental frequency obtained with the complex cepstrum is 231.81 Hz and the estimate with the zero-crossing detector is 233.27 Hz.

## Analytic Signal for Cosine

This example shows that the imaginary part of the analytic signal corresponding to a cosine is a sine with the same frequency. If the cosine has a nonzero mean (DC shift), the real part of the analytic signal is the original cosine with the same mean, but the imaginary part has zero mean.

Create a cosine with a frequency of 100 Hz. The sampling frequency is 10 kHz. Add a DC offset of 2.5 to the cosine.

```
t = 0:1e-4:1;  
x = 2.5+cos(2*pi*100*t);
```

Use `hilbert` to obtain the analytic signal. The real part is equal to the original signal. The imaginary part is the Hilbert transform of the original signal. Plot the real and imaginary parts for comparison.

```
y = hilbert(x);  
plot(t,real(y),'b','linewidth',2);  
hold on;  
plot(t,imag(y),'r','linewidth',2);  
set(gca,'xlim',[0 0.1]); grid on;  
xlabel('Seconds');
```

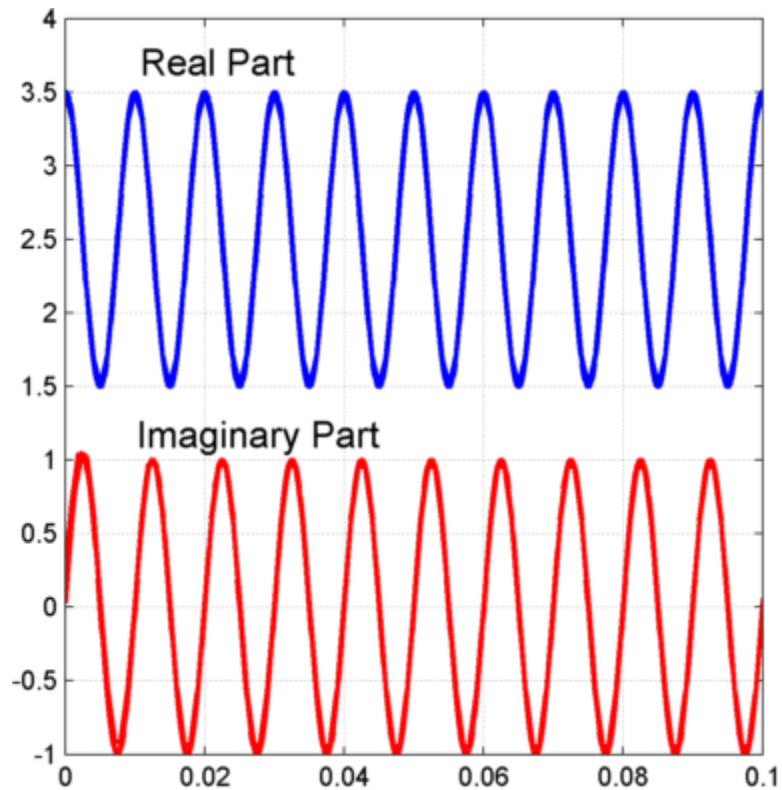

You see that the imaginary part is a sine with the same frequency as the cosine real part. However, the imaginary part has a mean of zero, while the real part has a mean of 2.5.

The original signal is

$$x(t) = 2.5 + \cos(2\pi 1000t)$$

The resulting analytic signal is

$$z(t) = 2.5 + e^{(j2\pi 1000t)}$$

Plot 10 periods of the complex-valued analytic signal.

```
plot3(t(1:1e3),real(y(1:1e3)),imag(y(1:1e3)));  
xlabel('Time','fontsize',14); ylabel('Re{z(t)}','fontsize',14);  
zlabel('Im{z(t)}','fontsize',14);
```

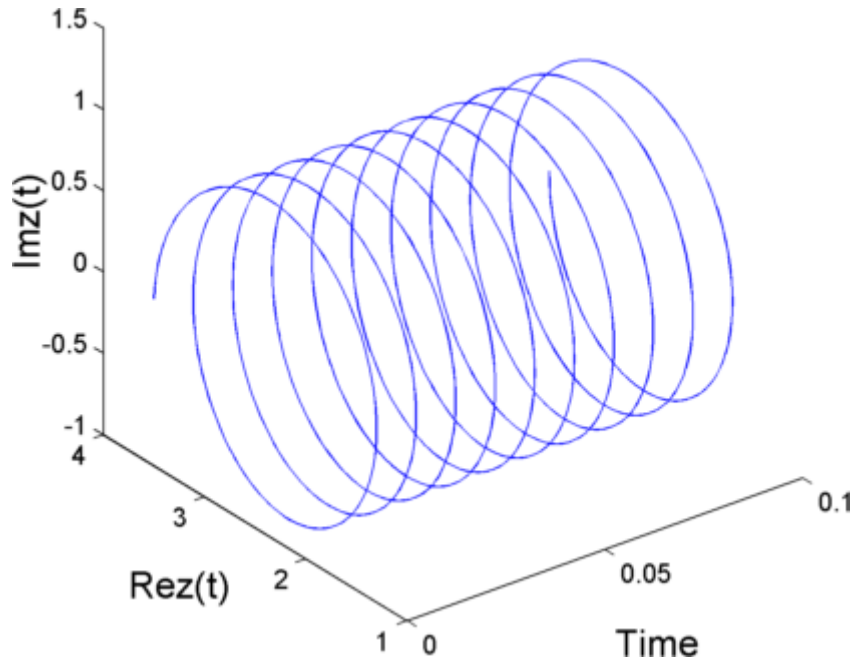



## Envelope Extraction Using The Analytic Signal

This example shows how to extract the signal envelope using the analytic signal.

Create a double sideband amplitude-modulated signal. The carrier frequency is 1 kHz. The modulation frequency is 50 Hz. The modulation depth is 100%. The sampling frequency is 10 kHz.

```
t = 0:1e-4:1;  
x = [1+cos(2*pi*50*t)].*cos(2*pi*1000*t);  
plot(t,x); set(gca,'xlim',[0 0.1]);  
xlabel('Seconds'); ylabel('Amplitude');
```

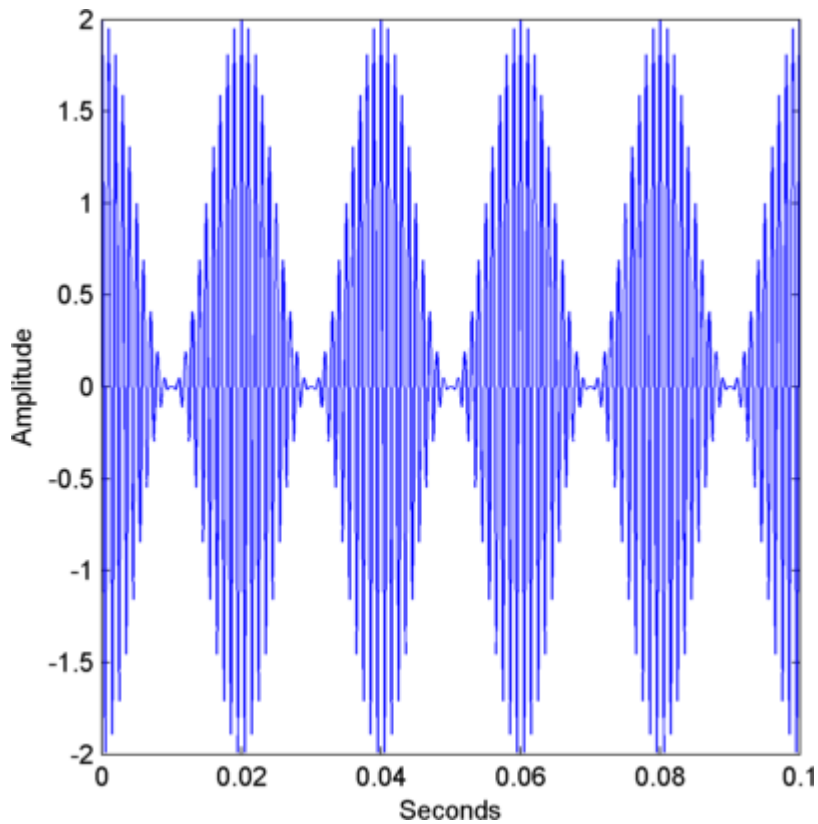

Obtain the analytic signal. Extract the envelope, which is the magnitude (modulus) of the analytic signal. Plot the envelope along with the original signal.

```
y = hilbert(x);  
env = abs(y);  
plot(t,x); hold on;  
plot(t,abs(y),'r','linewidth',2);  
plot(t,-abs(y),'r','linewidth',2);  
set(gca,'xlim',[0 0.1]);  
xlabel('Seconds'); ylabel('Amplitude');
```

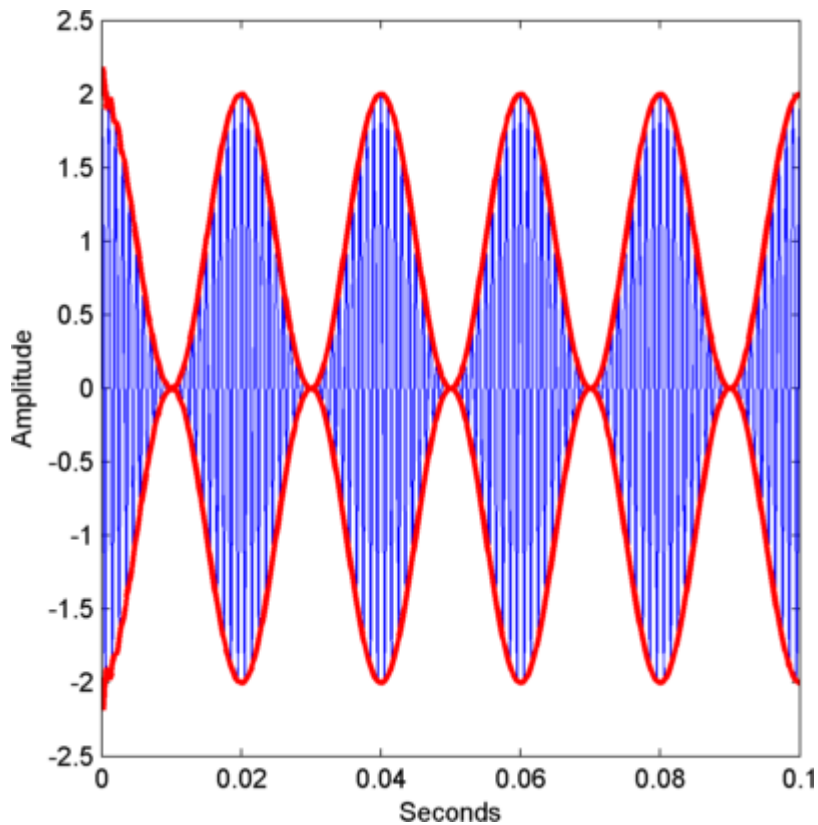

The magnitude of the analytic signal captures the slowly varying features of the signal, while the phase contains the high frequency information.

# Signal Generation

---

## Display Time-Domain Data in Signal Browser

### In this section...

“Import and Display Signals” on page 15-3

“Configure the Signal Browser Properties” on page 15-6

“Modify the Signal Browser Display” on page 15-9

“Inspect Your Data (Scaling the Axes and Zooming)” on page 15-11

This example shows how to use and configure the SPTool Signal Browser to display time-domain signals. First, open SPTool by typing

```
sptool
```

at the MATLAB command line. SPTool opens.

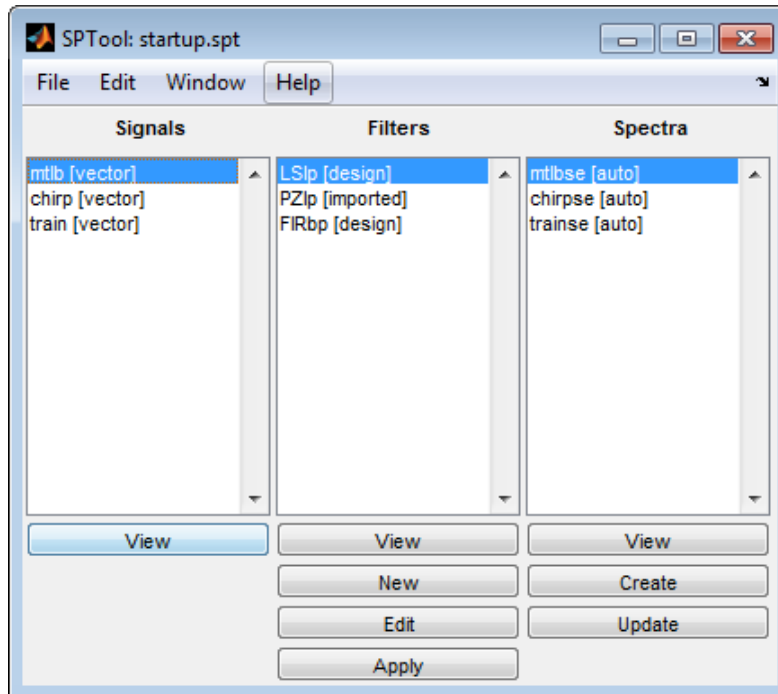

## Import and Display Signals

### Displaying Multiple Signals

You can display multiple signals in the Signal Browser by selecting more than one entry in the SPTool **Signals** list. In the **Signals** list, first select `mt1b [vector]`. Next, press the **Ctrl** key, and select `chirp [vector]`. Finally, click the **View** button. The Signal Browser opens, displaying both signals.

Any signals that you select in SPTool are now visible in the Signal Browser. You can also select multiple entries using the **Shift** key. In the SPTool **Signals** list, first select `mt1b [vector]`. Next, press the **Shift** key, and select `train [vector]`. The Signal Browser automatically updates to display all three signals, as shown in the following figure.

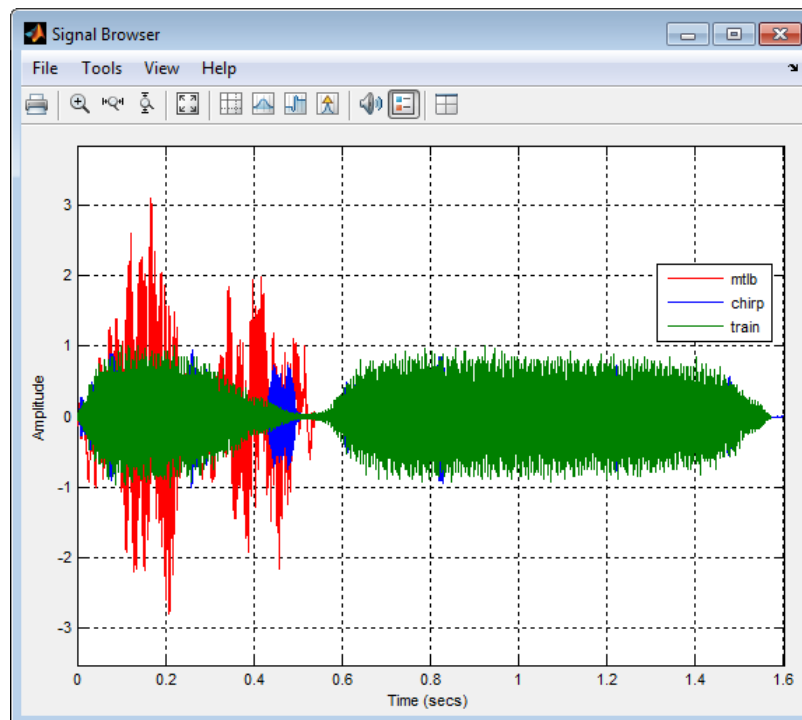



## Importing New Signals

Using SPTool, you can import signals from variables in the MATLAB workspace. First, create a 3-second signal, sampled at 10 kHz, that is the sum of two sine waves. At the MATLAB command line, enter the following commands:

```
Fs = 1e4;
t = 0:1/Fs:3;
s = sum(sin(2*pi*[350;440]*t));
```

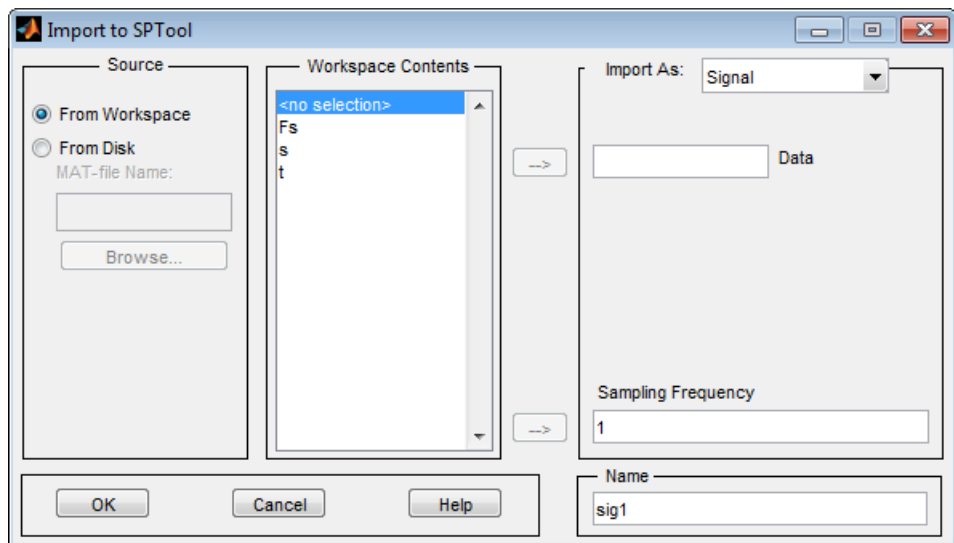
To import the signal from these variables, in the SPTool menu, select **File > Import**. Alternatively, you can press the **Ctrl+I** keyboard shortcut. The Import to SPTool dialog box opens.



From the **Workspace Contents** list, select **s**. Click the right arrow () button to the left of the **Data** box. Next, from the **Workspace Contents** list, select **Fs**. Click the right arrow () button to the left of the **Sampling Frequency** box. You can assign the signal a name in the **Name** box, but since you will rename the signal later in this example, leave it as **sig1** for now.

Click **OK**. The SPTool **Signals** list now contains a signal named `sig1` [vector].

### Selecting a Signal and Playing Audio

In the SPTool **Signals** list, select `sig1` [vector], and click the **View** button. The Signal Browser reappears in front. To play audio for the signal, click the

Play selected signal (🔊) button. Signal Browser sends the audio signal to the speaker. For more information, see `sound` in the MATLAB documentation.

If you have multiple signals selected in SPTool, you can use the **Trace Selection** panel to choose which signal to make active. In the SPTool **Signals** list, press the **Ctrl** key, and select `mtlb` [vector]. The Signal Browser now displays two signals. In the Signal Browser menu, select **Tools > Measurements > Trace Selection**. The **Trace Selection** panel appears as shown in the following figure.

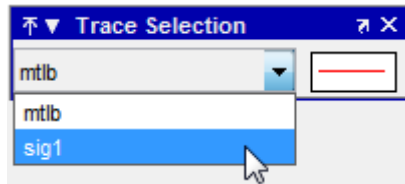

In the **Trace Selection** panel drop-down list, select `sig1`. Then, click the Play selected signal (🔊) button. Signal Browser sends the audio signal to the speaker.

---

**Note** To hear audio when you click the Play selected signal (🔊) button, your computer sound card must be able to support the sample rate of the signal. In this example, the sample rate of the signal, `sig1` [vector], is 10 kHz. If your sound card supports this or a greater sample rate, such as 44.1 kHz, then you can hear the audio on your speaker. For more information, see `sound` in the MATLAB documentation.

---

## Change Signal Names from the Legend

When multiple signals are displayed, Signal Browser shows a legend by default. To turn off the legend, click the Show all legends () button. Click the button again to turn the legend back on. You can modify the names of the signal directly in the legend. To do so, when the legend is visible, click and drag it to any location on the display.

You can change the name of any signal directly within the legend. In the legend, double-click the signal name sig1. A cursor appears, indicating that you can now change this name. Highlight the text, and type Dial Tone. The legend now shows Dial Tone as the name of that signal. In the SPTool **Signals** list, the last item is now also named Dial Tone.

## Configure the Signal Browser Properties

First, configure the appearance of the Signal Browser window. In the SPTool **Signals** list, first select mt1b [vector]. Next, press the **Shift** key, and select train [vector]. The Signal Browser automatically updates to display all three signals.

## Multiple Displays

You can display multiple signals on different displays in the Signal Browser window. In the SPTool **Signals** list, first ensure all three signals are selected.

In the Signal Browser toolbar, click the Layout () button. Select row 3, column 1, as shown in the following figure.

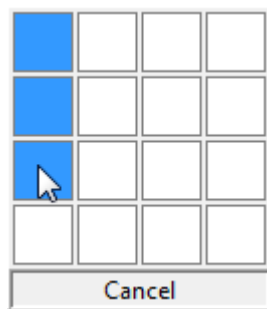



After you make this selection, the Signal Browser is separated into three displays.

### Configure Appearance

In the Signal Browser menu, select **View > Properties**. The Visuals:Time Domain Options dialog box opens, as shown in the following figure.

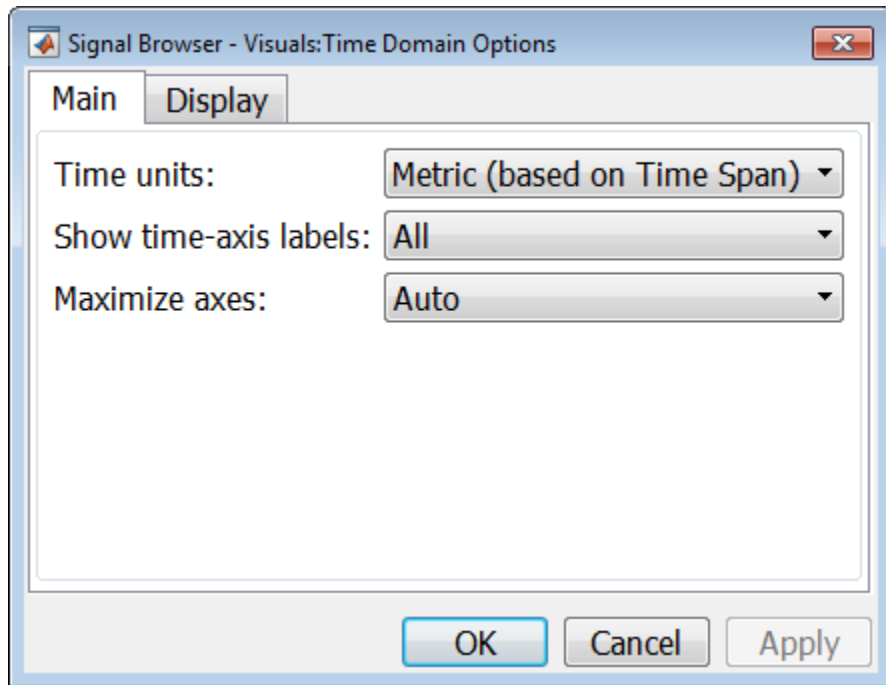

In the Visuals:Time Domain Options dialog box, click the **Main** tab. Choose the appropriate parameter settings for the **Main** tab, as shown in the following table.

Parameter	Setting
Time units	Metric (based on Time Span)
Show time-axis labels	Bottom Displays Only
Maximize axes	On

When you change the **Maximize axes** parameter to On, the axes are expanded to fill the entire display. To conserve space, titles and axis labels are not shown in each display. Click **Apply**.

### Set Display Properties

In the Visuals:Time Domain Options dialog box, click the **Display** tab. You can change the value of the **Select display** parameter to make different settings for each display. Set the parameters to the values shown in the following table.

Parameter	Display 1 Setting	Display 2 Setting	Display 3 Setting
Select display	1	2	3
Title	mtlb	chirp	train
Show legend	Selected	Selected	Selected
Show grid	Selected	Selected	Selected
Plot signal(s) as magnitude and phase	Cleared	Cleared	Cleared
Minimum Y-limit	-2.5	-1	-1.5
Maximum Y-limit	2.5	1	1.5
Y-axis label	Amplitude	Amplitude	Amplitude

Click **OK** to save your changes and close the Visuals:Time Domain Options dialog box. The Signal Browser appears as shown in the following figure.

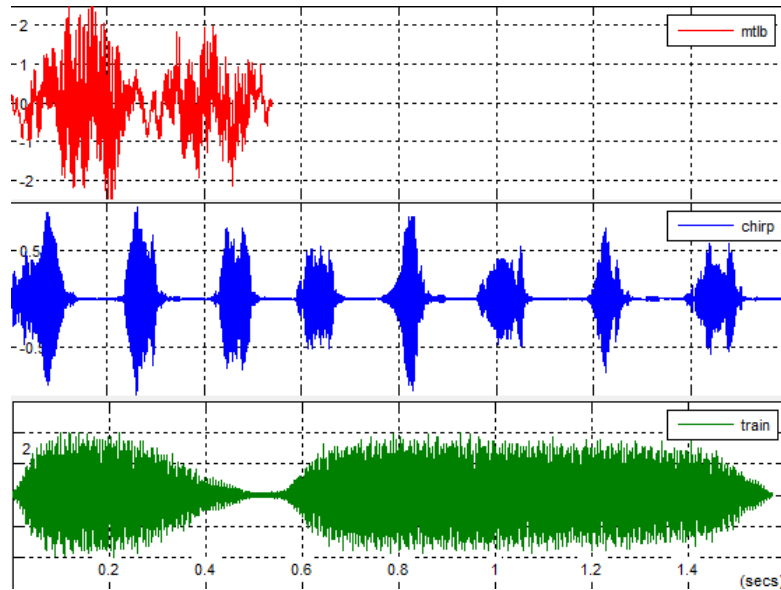

## Modify the Signal Browser Display

Use the Style dialog box to modify the appearance of the axes and the lines for each of the selected signals in SPTool. In the Signal Browser menu, select **View > Style**. The Style dialog box opens, as shown in the following figure.

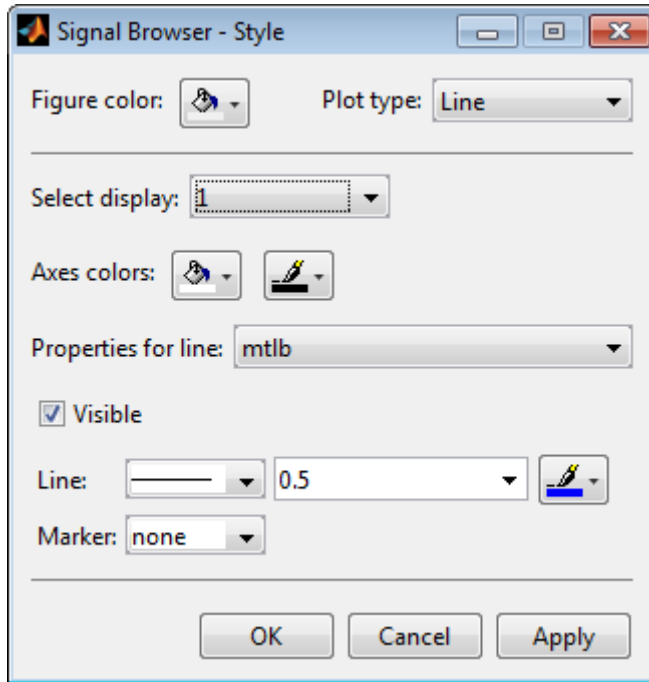

### Modify Axes Colors and Line Properties

You can change the value of the **Select display** parameter to make different settings for each display. Set the parameters to the values shown in the following table.

Parameter	Display 1 Setting	Display 2 Setting	Display 3 Setting
Select display	1	2	3
Axes background color	Black	Black	Black
Ticks, labels, and grid colors	White	White	White
Line color	Yellow	Cyan	Magenta

These settings enable the Signal Browser to display line colors in the same manner as the Simulink Scope block. Click **OK** to save your changes and close the Style dialog box. The Signal Browser now appears as shown in the following figure.

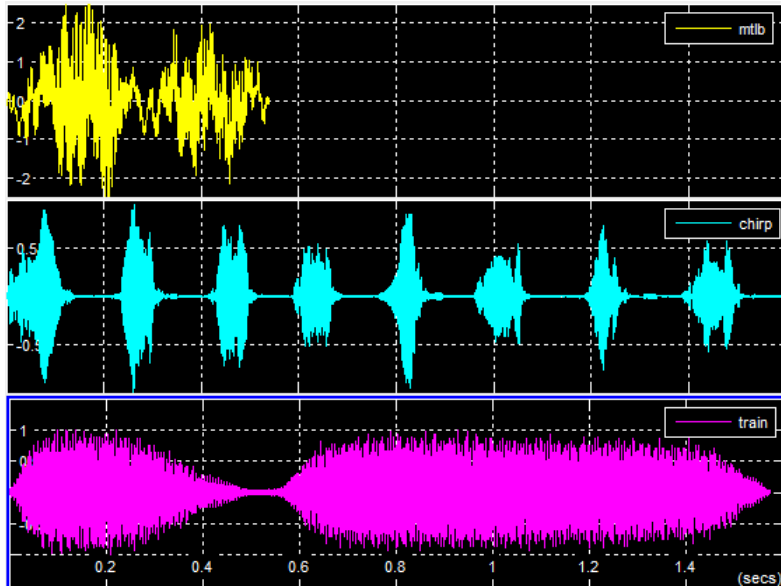

### Show and Hide Toolbar

To hide the toolbar, from the Signal Browser menu, select **View > Toolbar**. Doing so removes the toolbar from the Signal Browser window and also removes the check mark beside the **Toolbar** option in the **View** menu. You can choose to show the toolbar again at any time by selecting **View > Toolbar**.

### Inspect Your Data (Scaling the Axes and Zooming)

So far, you have manually set the y-axis limits. Use one of the following options to let Signal Browser scale the axes:

- From the Signal Browser menu, select **Tools > Scale Axes Limits**.
- From the Signal Browser toolbar, click the Scale Axes Limits () button.

- With the Signal Browser as your active window, press **Ctrl + A**.

### Use the Zoom Tools

The zoom tools allow you to zoom in simultaneously in the directions of both the  $x$ - and  $y$ -axes, or in either direction individually. For example, to zoom in on the signal between 0 and 0.5 seconds, you can use the **Zoom X** option.

- To activate the **Zoom X** tool, select **Tools > Zoom X**, or press the corresponding toolbar button ("Q"). The Signal Browser indicates that the **Zoom X** tool is active by indenting the toolbar button and placing a check mark next to the **Tools > Zoom X** menu option.
- Next, zoom in on the region between 0 and 0.5 seconds. In the Signal Browser window, click on the 0-second mark and drag to the 0.5-second mark. All three displays reflect this new  $x$ -axis setting, as shown in the following figure.

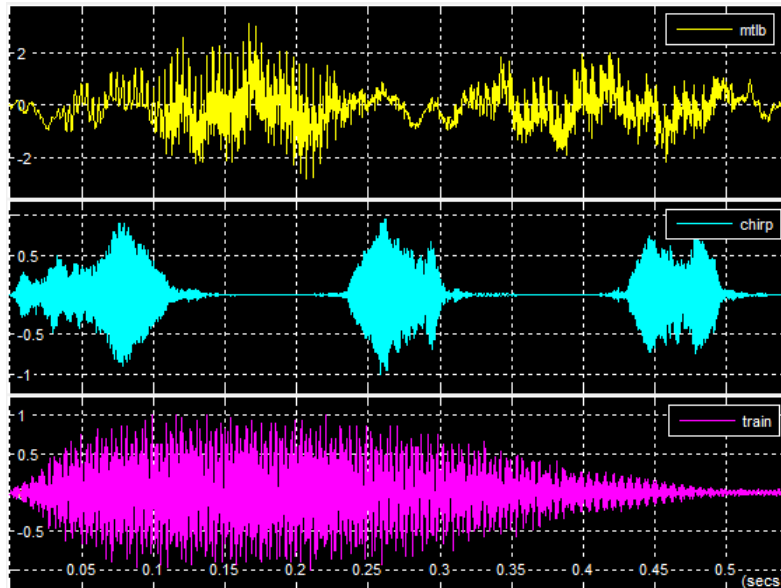

- To zoom out of the Signal Browser window, right-click inside the window, and select **Zoom Out**. Alternatively, you can return to the original view

of your signal by right-clicking inside the Signal Browser window and selecting **Reset to Original View**.





# Signal Measurement

---

- “RMS Value of Periodic Waveforms” on page 16-2
- “Slew Rate of Triangular Waveform” on page 16-5
- “Duty Cycle of Rectangular Pulse Waveform” on page 16-9
- “Estimate State for Digital Clock” on page 16-12
- “Calculate Settling Time with Signal Browser” on page 16-16
- “Find Peak Amplitudes in Signal Browser” on page 16-20

## RMS Value of Periodic Waveforms

This example shows you how to find the root mean square (RMS) value of a sine wave, a square wave, and a rectangular pulse train using `rms`. The waveforms in this example are discrete-time versions of their continuous-time counterparts. The following table gives the RMS values of a continuous-time sine wave, square wave, and rectangular pulse with duty cycle,  $D$ .

Waveform	RMS Value
Sine wave with amplitude $A$	$A/\sqrt{2}$
Square wave with values of $A$ and $-A$	$A$
Rectangular pulse with duty cycle $D$ and amplitude (on value) $A$	$A\sqrt{D}$

Create a discrete-time sine wave. Compute the RMS value and show that it is a good approximation to the theoretical value for a continuous-time sine wave.

Create a sine wave with a frequency of  $\pi/4$  radians/sample. The length of the sine wave is 16 samples, which equals two periods of the sine wave.

```
n = 0:15;
x = cos(pi/4*n);
```

Compute the RMS value of the sine wave.

```
rmsval = rms(x)
```

The RMS value is equal to 0.7071 as expected.

Create a periodic square wave with a period of 0.1 seconds. The square wave values oscillate between  $-2$  and  $2$

```
t = 0:0.01:1;
x = 2*square(2*pi*10*t);
stem(t,x,'markerfacecolor',[0 0 1]); axis([0 1 -2.5 2.5]);
```

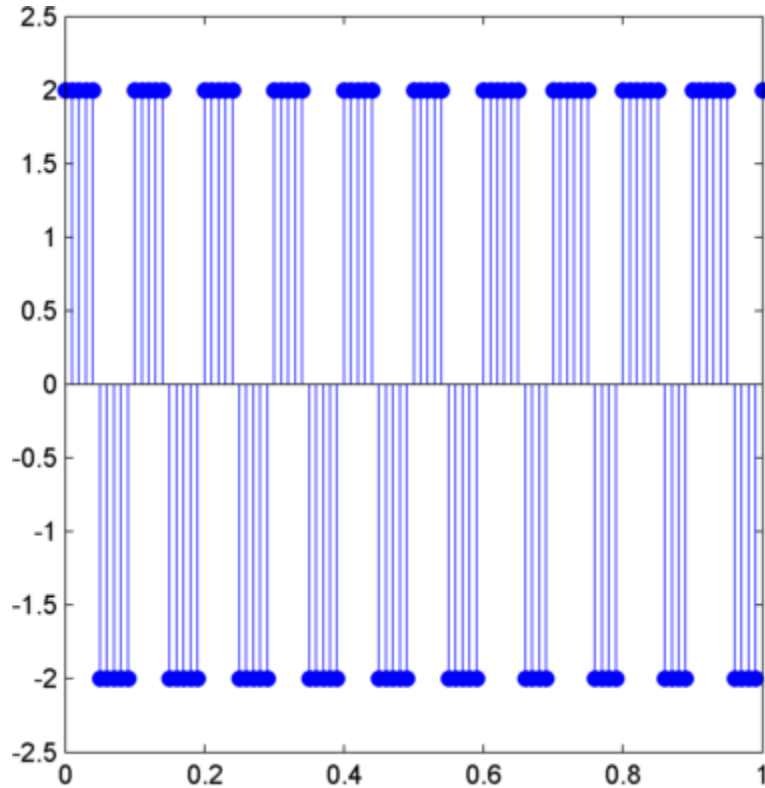

Find the RMS value.

```
rmsval = rms(x)
```

The RMS value agrees with the theoretical value of 2.

Create a rectangular pulse train sampled at 1 kHz with the following parameters: the pulse is on, or equal to 1, for 0.025 seconds and off, or equal to 0, for 0.075 seconds in each 0.1 second interval. This means the pulse period is 0.1 seconds and the pulse is on for 1/4 of that interval. This is referred to as the *duty cycle*. See “Duty Cycle of Rectangular Pulse Waveform” on page 16-9 for a more detailed example of duty cycle. Use `pulstran` to create the rectangular pulse train.

```
t = 0:0.001:(10*0.1);
```

```
pulsewidth = 0.025;  
pulseperiods = [0:10]*0.1;  
x = pulstran(t,pulseperiods,@rectpuls,pulsewidth);  
plot(t,x); axis([0 1 -0.5 1.5]);  
xlabel('Seconds'); ylabel('Amplitude');
```

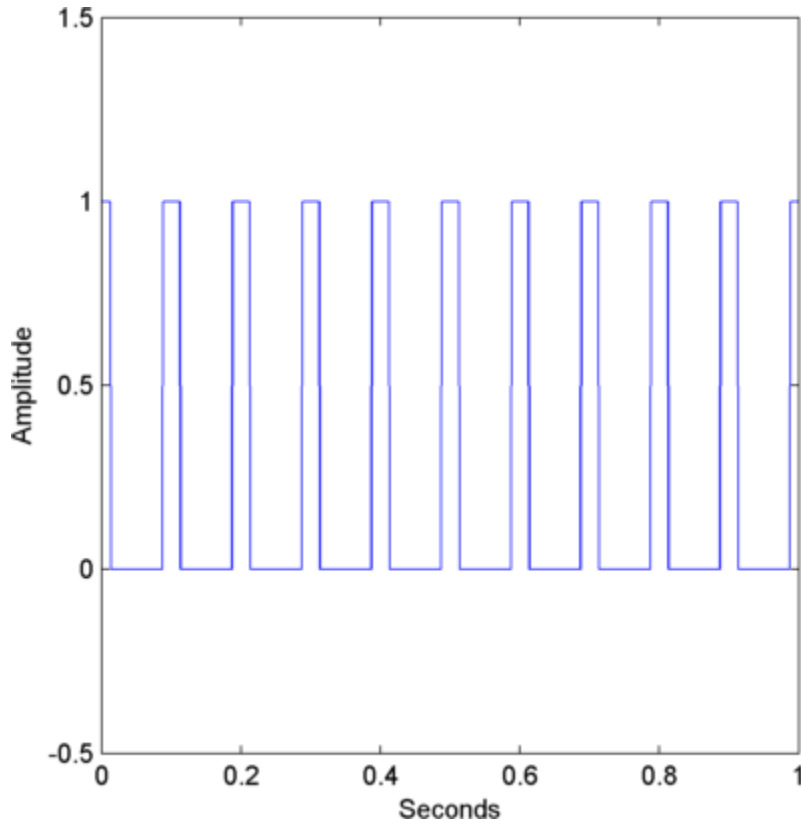

Find the RMS value and compare it to the RMS of a continuous-time rectangular pulse waveform with duty cycle 1/4 and peak amplitude 1.

```
rmsval = rms(x)  
thrms = sqrt(1/4)
```

The observed RMS value and the RMS value for a continuous-time rectangular pulse waveform are in good agreement.

## Slew Rate of Triangular Waveform

This example shows you how to use the slew rate as an estimate of the rising and falling slopes of a triangular waveform.

Create three triangular waveforms. One waveform has rising-falling slopes of  $\pm 2$ , one waveform has rising-falling slopes of  $\pm 1/2$ , and one waveform has a rising slope of  $+2$  and a falling slope of  $-1/2$ . Use `slewrates` to find the slopes of the waveforms.

Create a triangular waveform with rising-falling slopes of  $\pm 2$ . Set the sampling interval to 0.01 seconds, which corresponds to a sampling frequency of 100 hertz.

```
t = 0:0.01:1;
x = 2*t;
x = [x fliplr(x)];
tnew = [t t+1.01];
plot(tnew,x); xlabel('Time');
ylabel('Amplitude');
```

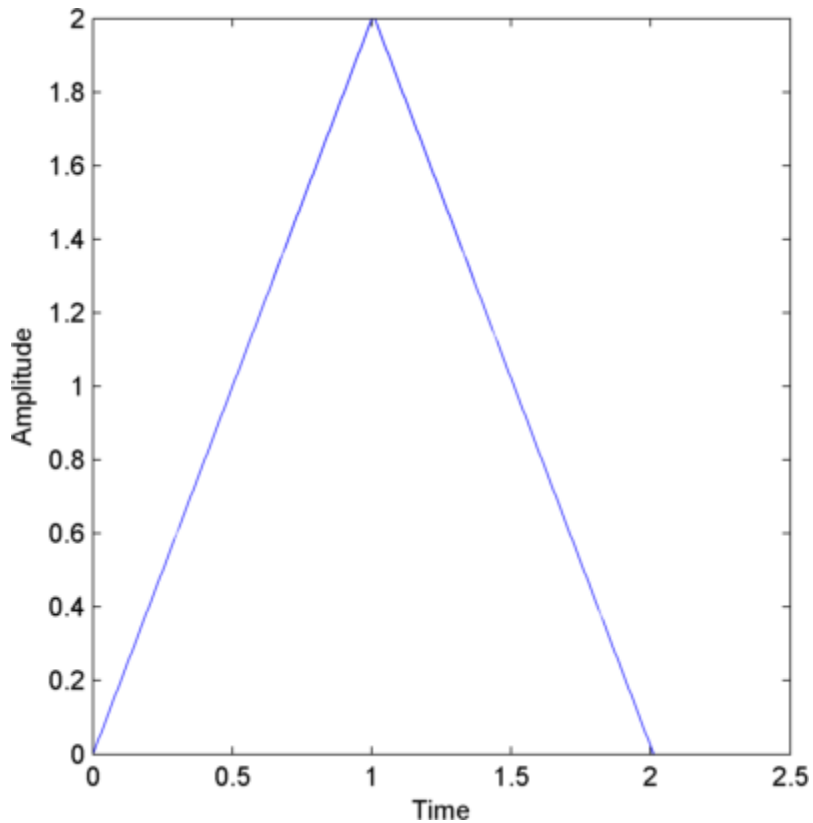

Calculate the slew rate for the triangular waveform. Input the sampling frequency (100 Hz) to obtain the correct positive and negative slope values.

```
s = slewrate(x,100)
```

Create a triangular waveform with slopes of  $\pm 1/2$ . Set the sampling interval to 0.01 seconds, which corresponds to a sampling frequency of 100 hertz.

```
t = 0:0.01:1;  
x = 1/2*t;  
x = [x fliplr(x)];  
tnew = [t t+1.01];  
plot(tnew,x); xlabel('Time');  
ylabel('Amplitude');
```

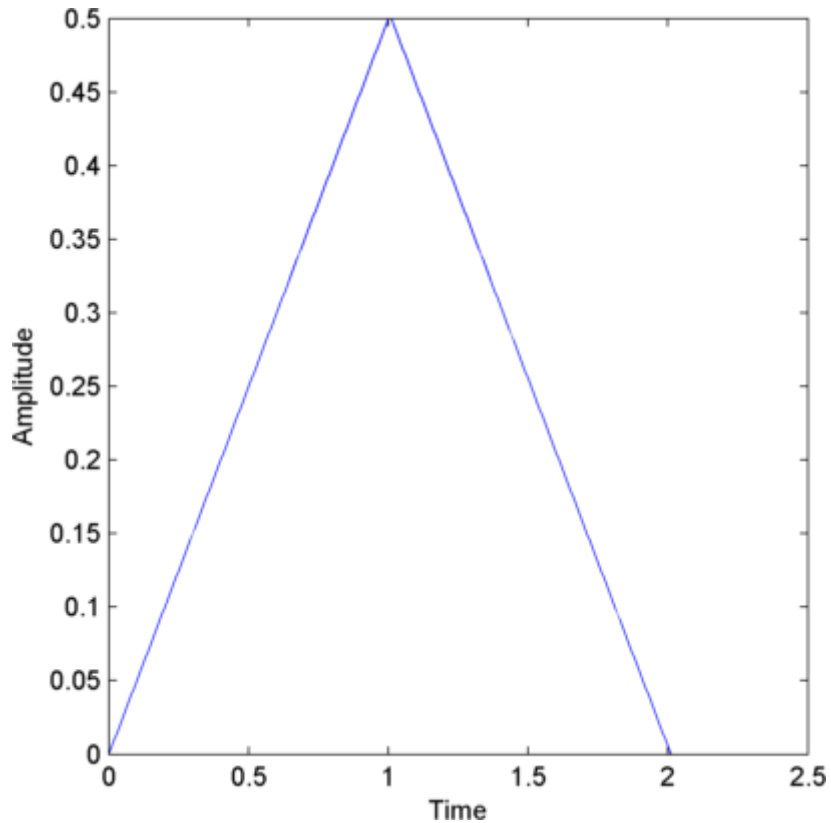

Calculate the slew rate for the triangular waveform. Input the sampling frequency (100 Hz) to obtain the correct positive and negative slope values.

```
s = slewrate(x,100)
```

Create a triangular waveform with a rising slope of +2 and a falling slope of -1/2. Set the sampling increment to 0.01 seconds, which corresponds to a sampling frequency of 100 hertz.

```
t = 0:0.01:1;  
x = 2*t;  
t1 = 1:0.01:5;  
x1 = -1/2*(t1-1)+2;  
y = [x x1];
```

```
tnew = [t t1];  
plot(tnew,y); xlabel('Time');  
ylabel('Amplitude');
```

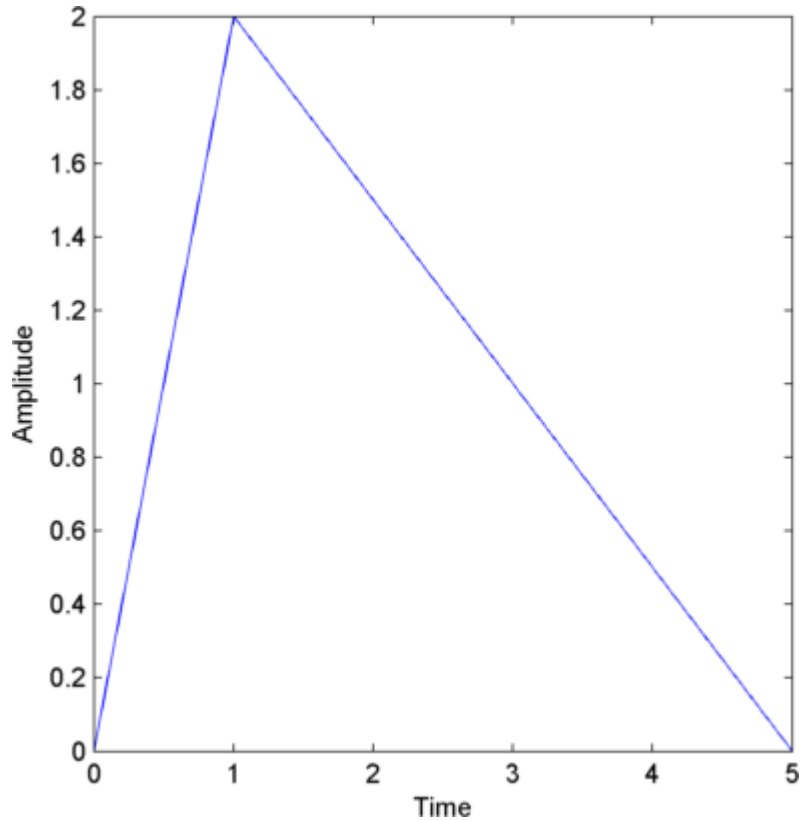

Determine the slew rate.

```
s = slewrate(y,100)
```

The first element of **s** is the rising slope and the second element is the falling slope.



## Duty Cycle of Rectangular Pulse Waveform

This example shows you how to create a rectangular pulse waveform and measure the duty cycle. You can think of a rectangular pulse waveform as a sequence of *on* and *off* states. One pulse period is the total duration of an *on* and *off* state. The pulse width is the duration of the *on* state. The duty cycle is the ratio of the pulse width to the pulse period. The duty cycle for a rectangular pulse describes the fraction of time that the pulse is *on* in one pulse period.

Create a rectangular pulse sampled at 1 gigahertz. The pulse is on, or equal to 1, for a duration of 1 microsecond. The pulse is off, or equal to 0, for a duration of 3 microseconds. The pulse period is 4 microseconds. Measure the duty cycle of the waveform.

Set the sampling frequency equal to 1 gigahertz. Create a vector of times long enough to accommodate 10 pulses. Define the pulse width to be 1 microsecond. Space the pulses at intervals of 4 microseconds, which determines the pulse period. Use `pulstran` to generate the pulse train and plot the result.

```
Fs = 1e9;  
t = 0:1/Fs:(10*4e-6);  
pulsewidth = 1e-6;  
pulseperiods = [0:10]*4e-6;  
x = pulstran(t,pulseperiods,@rectpuls,pulsewidth);  
plot(t.*1e6,x); axis([0 40 -0.5 1.5]);  
xlabel('\mus'); ylabel('Amplitude');
```

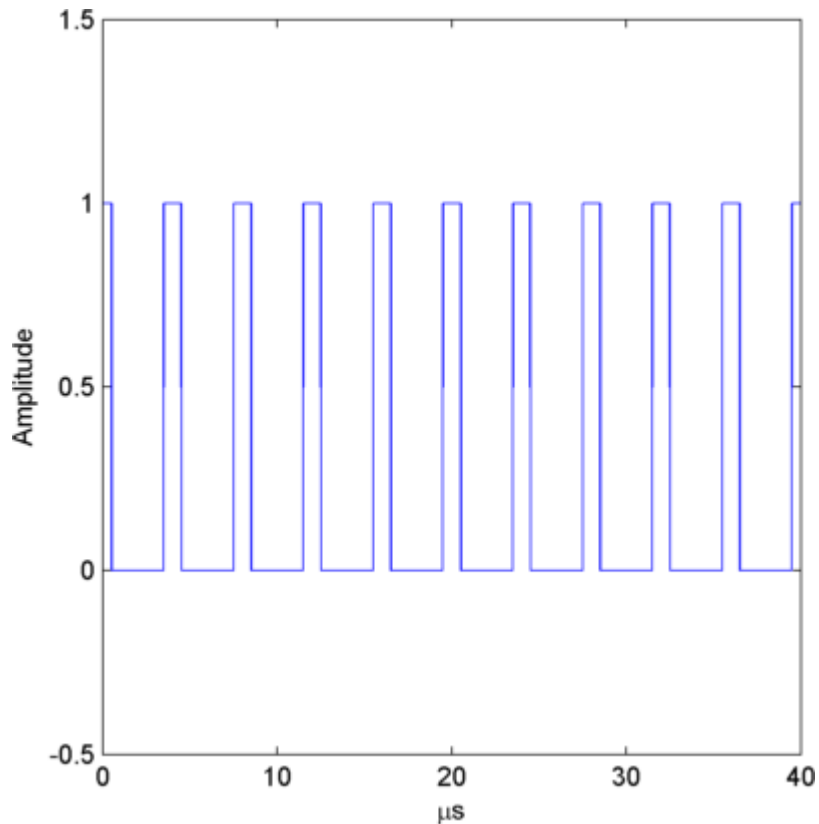

Determine the duty cycle using `dutycycle`. Input both the pulse waveform and the sampling frequency to output the duty cycle. `dutycycle` outputs a duty cycle value for each detected pulse.

```
D = dutycycle(x,Fs)
```

In this example, the duty cycle for each of the 10 detected pulses is identical and equal to 0.25. This is the expected duty cycle because the pulse is on for 1 microsecond and off for 3 microseconds in each 4 microsecond period. Therefore, the pulse is on for 1/4 of each period. Expressed as a percentage, this is equal to a duty cycle of 25%.

Calling `dutycycle` with no output arguments produces a plot with all the detected pulse widths marked.

```
dutycycle(x,Fs);
```

Using the same sampling rate and pulse period, vary the pulse on time (pulse width) from 1 to 3 microseconds in a loop and calculate the duty cycle. Plot the pulse waveforms and display the duty cycle value in the plot title for each step through the loop. You see the duty cycle increase from 0.25 (1/4) to 0.75 (3/4) as the pulse width increases.

```
pulsewidths = 1e-6:1e-6:3e-6;
for nn = 1:length(pulsewidths)
    x = pulstran(t,pulseperiods,@rectpuls,pulsewidths(nn));
    plot(t.*1e6,x); axis([0 40 -0.5 1.5]);
    xlabel('\mus'); ylabel('Amplitude');
    D = dutycycle(x,Fs);
    title(['Duty cycle is ' num2str(mean(D)) ]);
    pause(1);
end
```

## Estimate State for Digital Clock

This example shows you how to estimate the high and low *state* levels for digital clock data. In contrast to analog voltage signals, signals in digital circuits have only two states: HIGH and LOW. Information is conveyed by the pattern of high and low state levels.

Load `clockex.mat` into the MATLAB workspace. `clockex.mat` contains a 2.3 volt digital clock waveform sampled at 4 megahertz. Load the clock data into the variable, `x`, and the vector of sampling times in the variable, `t`. Plot the data.

```
load('clockex.mat','x','t')
stem(t,x,'markerfacecolor',[0 0 1]); xlabel('Seconds'); ylabel('Volts');
```

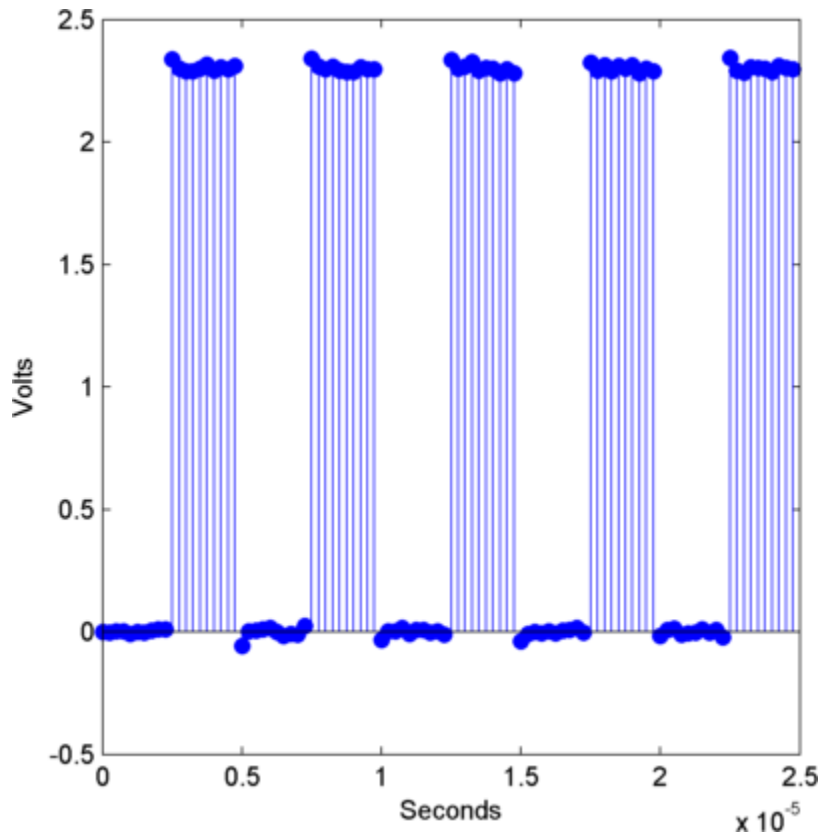

Determine the high and low state levels for the clock data using `statelevels`.

```
levels = statelevels(x)
```

The low-state level estimate is 0.0027 volts and the high-state level estimate is 2.3068 volts. This is the expected result for the 2.3 volt clock data, where the noise-free low-state level is 0 volts, and the noise-free high-state level is 2.3 volts.

Use the estimated state levels to convert the voltages into a sequence of 0s and 1s. The sequence of 0s and 1s is a binary waveform representation of the two states. To make the assignment, use the following decision rule. Assign any

voltage within a 3%-tolerance region of the low-state level the value 0, and any voltage within a 3%-tolerance region of the high-state level the value 1.

Determine the 3%-tolerance region around the low-state level.

```
lowtol = [levels(1)-3/100*(levels(2)-levels(1)) ...  
         levels(1)+3/100*(levels(2)-levels(1))];
```

Determine the 3%-tolerance region around the high-state level.

```
hightol = [levels(2)-3/100*(levels(2)-levels(1)) ...  
          levels(2)+3/100*(levels(2)-levels(1))];
```

Use logical indexing to determine the voltages within a 3%-tolerance region of the low-state level and the voltages within a 3%-tolerance region of the high-state level. Assign the value 0 to the voltages within the tolerance region of the low-state level and 1 to the voltages within the tolerance region of the high-state level. Plot the result.

```
y = zeros(size(x));  
y(x>= lowtol(1) & x<= lowtol(2)) = 0;  
y(x>= hightol(1) & x<= hightol(2)) = 1;  
subplot(211)  
stem(t,x,'markerfacecolor',[0 0 1]); ylabel('Volts');  
subplot(212)  
stem(t,y,'markerfacecolor',[0 0 1]); ylabel('{0,1}'); xlabel('Seconds');  
set(gca,'ytick',[0 1])
```

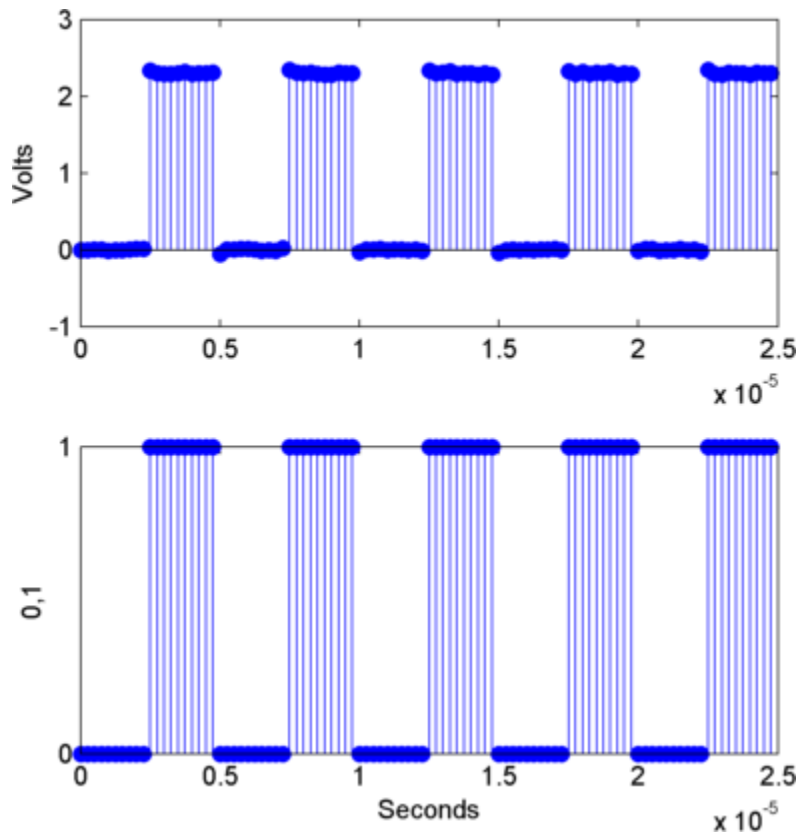

The decision rule has assigned all the voltages to the correct state.

## Calculate Settling Time with Signal Browser

This example demonstrates how you can use the SPTool Signal Browser to find the settling time of a clock signal in the Bilevel Measurements panel.

First, open SPTool by typing

```
sptool
```

at the MATLAB command line. SPTool opens.

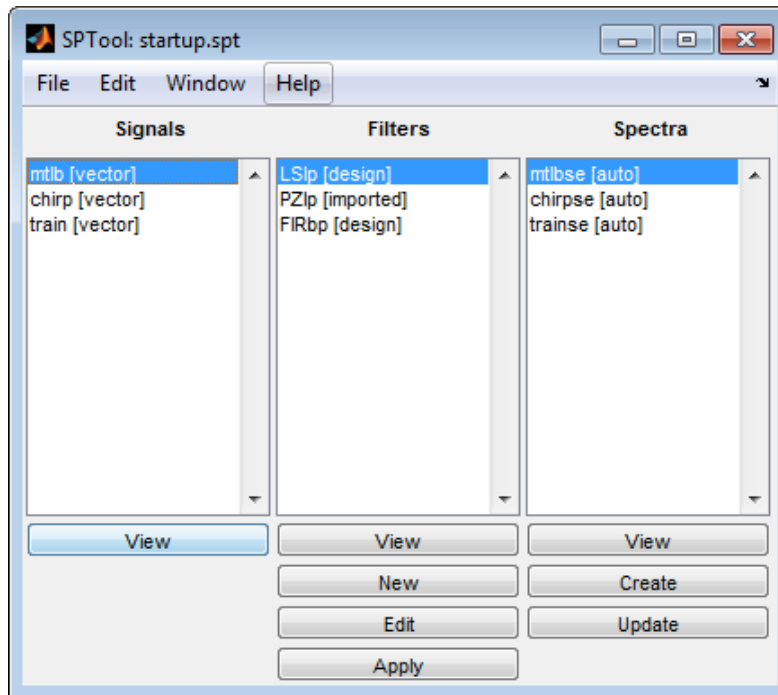

In this example, you import a clock signal from the MAT-file named `clockex.mat`. In the SPTool menu, select **File > Import**. Alternatively, you can press the **Ctrl+I** keyboard shortcut. The Import to SPTool dialog box opens.



**1** Under **Source**, click **From Disk**.



- 2 In the **MAT-file** box, type `clockex`, and press **Enter**. The variables `x` and `t` appear under **File Contents**.
- 3 Under **File Contents**, click `x`. Click the right arrow () button to the left of the **Data** box.
- 4 In the **Sampling Frequency** box, type `4000000`.
- 5 In the **Name** box, type `Clock`.
- 6 Click **OK**. The SPTool **Signals** list now contains a signal named `Clock [vector]`.
- 7 In SPTool, in the **Signals** list, select `Clock [vector]`, and click the **View** button. The Signal Browser appears and displays the clock signal.

Because you selected only one signal, the legend is not needed. Turn off the legend by clicking the Show All Legends () button. Then, use the Style dialog box to modify the appearance of the axes and the lines for the signal. In the Signal Browser menu, select **View > Style**.

Parameter	Display 1 Setting
Axes background color	Black
Ticks, labels, and grid colors	Dark Gray
Line color	Yellow

To show the **Bilevel Measurements** panel, in the Signal Browser menu, select **Tools > Measurements > Bilevel Measurements**. To collapse the **Transitions** pane, click the pane collapse button () next to that label. To expand the **Settings** pane and the **Overshoots / Undershoots** pane, click the pane expand button () next to each label. The Signal Browser appears as shown in the following figure.

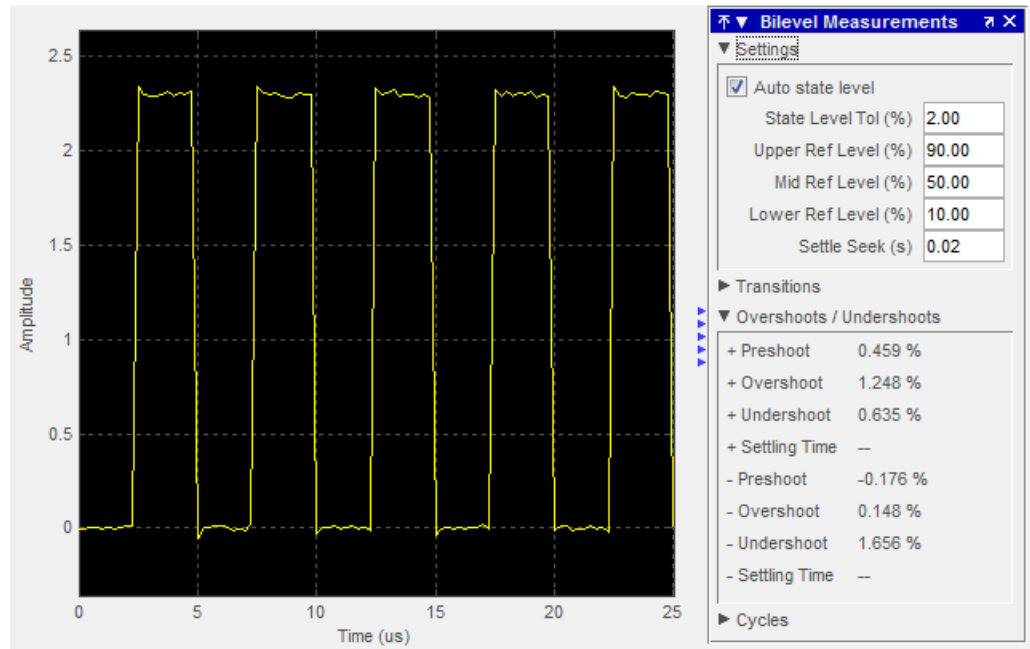

The value for the rising edge **Settling Time** parameter does not appear in the **Overshoots / Undershoots** pane because the **Settle Seek** parameter is too large. The **Settle Seek** value is longer than the entire simulation duration. Enter a value for settle seek of  $2e-6$ , and press **Enter**. Signal Browser now displays a rising edge settling time value of **118.392 ns**.

This settling time value displayed is actually the statistical average of the settling times for all five rising edges. To display the settling time for only one rising edge, you can zoom in on that transition. In the Signal Browser toolbar, click the Zoom X button (). Click the display near a value of 2 microseconds on the *time*-axis. Drag to the right, and release near a value of 4 microseconds on the *time*-axis. Signal Browser updates the rising edge **Settling Time** value to reflect the new time window, as shown in the following figure.

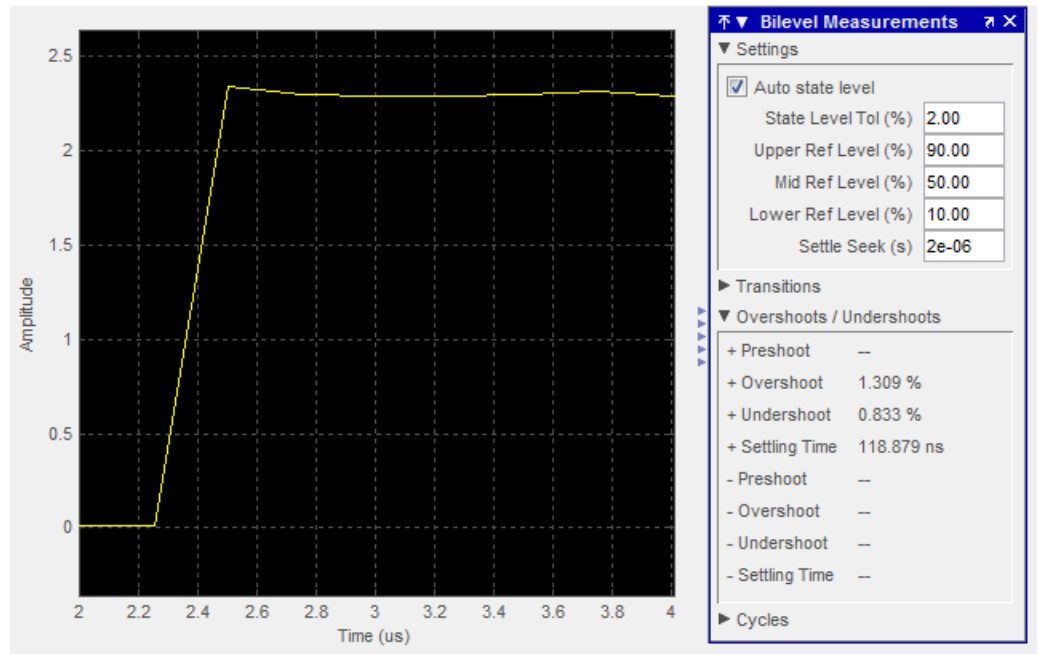

## Find Peak Amplitudes in Signal Browser

The following example demonstrates how you can use the Peak Finder panel to find heart rate, given an electrocardiogram (ECG) signal.

First, open SPTool by typing

```
sptool
```

at the MATLAB command line. SPTool opens.

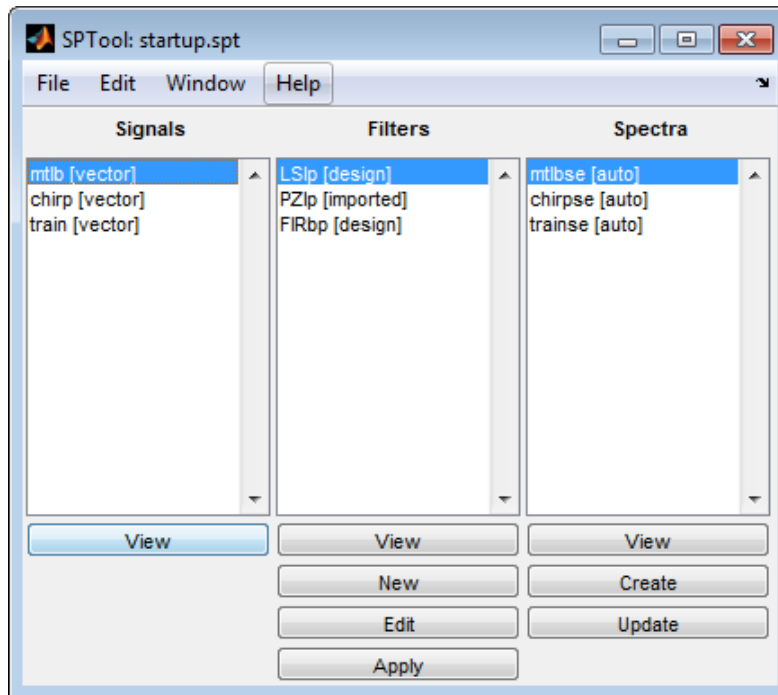



Using SPTool, you can import signals from variables in the MATLAB workspace. First, create an electrocardiogram (ECG) signal, sampled at 4 kHz, and apply the Savitzky-Golay filter. At the MATLAB command line, enter the following commands:

```
x1 = 3.5*ecg(2700).';
```

```
y1 = sgolayfilt(kron(ones(1,13),x1),0,21);  
n = (1:30000)';  
del = round(2700*rand(1));  
mhb = y1(n + del);  
ts = 0.00025;  
Fs = 1/ts;
```

For more information about the Savitzky-Golay filter, see the `sgolayfilt` function reference page or run the `sgolaydemo` example.

To import the signal from these variables, in the SPTool menu, select **File > Import**. Alternatively, you can press the **Ctrl+I** keyboard shortcut. The Import to SPTool dialog box appears.

- 1** Under **Workspace Contents**, click `mhb`. Click the right arrow () button to the left of the **Data** box.
- 2** Under **Workspace Contents**, click `Fs`. Click the right arrow () button to the left of the **Sampling Frequency** box.
- 3** In the **Name** box, type `ECG`.
- 4** Click **OK**. The SPTool **Signals** list now contains a signal named `ECG [vector]`.
- 5** In SPTool, in the **Signals** list, select `ECG [vector]`, and click the **View** button. The Signal Browser opens and displays the `ECG` signal.

Because you only selected one signal, the legend is not needed. Turn off the legend by clicking the Show All Legends () button. Then, use the Style dialog box to modify the appearance of the axes and the lines for the signal. In the Signal Browser menu, select **View > Style**.

Parameter	Display 1 Setting
Axes background color	Black
Ticks, labels, and grid colors	Dark Gray
Line color	Yellow

To show the **Peak Finder** panel, in the Signal Browser menu, select **Tools > Measurements > Peak Finder**. To expand the **Settings** pane, click the pane expand button (▶) next to that label. In the **Max Num of Peaks** box, type 10 and press the **Enter** key. Signal Browser now displays in the **Peaks** pane a list of 10 peak amplitude values, and the times at which they occur, as shown in the following figure.

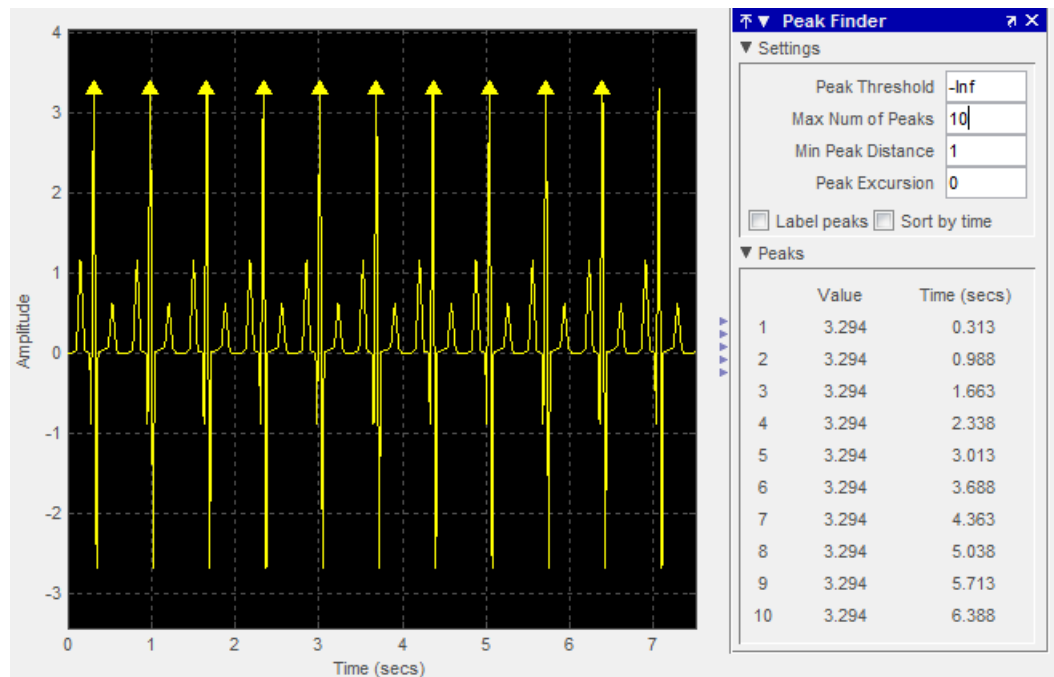

As you can see from the list of peak values, there is a constant time difference of 0.675 seconds between each heartbeat. Therefore, the heart rate detected by the ECG signal is given by the following equation.

$$\frac{60 \frac{\text{sec}}{\text{min}}}{0.675 \frac{\text{sec}}{\text{beat}}} = 88.89 \frac{\text{beats}}{\text{min}} (\text{bpm})$$





# Technical Conventions

---

This manual and all Signal Processing Toolbox functions use the following technical notations.

Term or Symbol	Description
Nyquist frequency	One-half the sampling frequency. Some toolbox functions normalize this value to 1.
$x(1)$	The first element of a data sequence or filter, corresponding to zero lag.
$\Omega$ or $w$	Analog frequency in radians per second.
$\omega$ or $w$	Digital frequency in radians per sample.
$f$	Digital frequency in hertz.
$[x, y)$	The interval from $x$ to $y$ , including $x$ but not including $y$ .
$\dots$	Ellipses in the argument list for a given syntax on a function reference page indicate all possible argument lists for that function appearing prior to the given syntax are valid.



## A

- aliasing
  - impulse invariance 2-47
  - preventing 7-22
  - reducing 7-40
- all-pole filters. *See* IIR filters
- all-zero filters. *See* FIR filters
- AM. *See* amplitude modulation
- analog filters 2-9 2-44
  - Bessel comparison 2-12
  - bilinear transformation 2-48
  - Butterworth comparison 2-9
  - Chebyshev Type I comparison 2-10
  - Chebyshev Type II comparison 2-10
  - design 2-7
  - discretization 2-46
  - frequency response example 2-13
  - impulse invariance 2-47
  - models 1-31
  - plotting 2-13
  - See also* IIR filters
- analog frequency A-1
- anti-symmetric filters 2-28
- AR models. *See* autoregressive (AR) models
- ARMA filters 1-4
  - coefficients 1-4
  - Prony's method 7-16
  - Steiglitz-McBride method 7-17
  - See also* IIR filters
- ARX models 7-16
- autocorrelation
  - estimation 6-4
  - multiple channel filters 6-4
  - variance 6-4
- autocovariance
  - multiple channels 6-4
- autoregressive (AR) models 1-3
  - coefficients 1-3
  - See also* IIR filters

- autoregressive moving-average (ARMA) filters.
  - See* ARMA filters

## B

- band edges
  - prewarping 2-50
- bandpass filters
  - Chebyshev Type I example 2-45
  - design 2-7
  - FIR 2-23
  - impulse invariance 2-47
- bandwidth 2-46
- barthannwin Bartlett Hann window function
  - comparison 7-2
- bartlett window function
  - comparison 7-2
- Bessel filters
  - characteristics 2-12
- bias 6-3
  - linear prediction 7-15
  - power spectral density 6-17
  - variance trade-off 6-4
  - Welch 6-24
- bilinear transformations
  - characteristics 2-48
  - prewarping example 2-50
- blackman window function
  - comparison 7-2
- blackmanharris window function
  - comparison 7-2
- bohmanwin window function
  - comparison 7-2
- boxcar windows. *See* rectangular windows
- brackets A-1
- Burg method
  - characteristics 6-37
  - example 6-38
  - spectral estimation 6-7
  - Welch's method comparison 6-39

- Butterworth filters
  - characteristics 2-9
  - comparison 2-9
  - generalized 2-15

## C

- C header files 5-32
- canonical forms 1-6
- carrier frequencies 7-30
- cascaes 1-28
- center frequency 2-46
- cepstrum 7-24
- chebwin Chebyshev window function
  - comparison 7-2
- Chebyshev Type I filters
  - characteristics 2-10
  - example 2-45
- Chebyshev Type II filters
  - characteristics 2-10
  - order estimation 2-8
- chirp z-transforms
  - characteristics 7-36
- CIC filters
  - exporting from FDATool to Simulink 5-29
- coefficients
  - accessing filter 8-29
  - filter 1-3
  - lattice 1-28
- coherence
  - definition 6-31
  - linearly dependent data 6-31
- colors
  - sptool GUI 8-44
- communications 7-30
  - applications 7-30
  - modeling 7-13
  - See also* modulation, demodulation, voltage controlled oscillation
- compaction

- discrete cosine transform 7-39
- complex envelope. *See* Hilbert transforms
- context-sensitive help 8-6
- continuous-time filters. *See* analog filters
- conversions
  - errors 5-24
  - functions (table) 1-32
- convolution
  - cross-correlation 6-3
  - filtering 1-2
  - matrix 1-30
- correlation 6-2
  - bias 6-3
  - linear prediction 7-15
  - See also* autocorrelation, cross-correlation
- cosine windows 7-6
- covariance 6-2
  - definition 6-8
  - methods 6-41
  - See also* autocovariance, cross-covariance, modified covariance method
- cross power spectral density
  - definition 6-29
- cross spectral density 6-29
  - definition 6-29
  - See also* power spectral density, spectral estimation
- cross-correlation
  - discussion 6-2
- cross-covariance
  - comparison to cross-correlation 6-2
  - multiple channels 6-4
- czt 7-36
  - See also* chirp z-transforms

## D

- data
  - tips 5-15
- DC component suppression 1-36

- deconvolution 7-35
- default session
  - sptool GUI 8-44
- delays
  - group 1-18
  - noninteger 2-30
  - phase 1-19
  - signals 2-29
- demodulation
  - example 7-31
- design methods 3-6
  - customize 3-8
- dft. *See* discrete Fourier transforms
- difference equations 1-24
- differentiators
  - definition 2-30
- digital audio tape standards 7-22
- digital filters 1-2
  - anti-causal 1-9
  - cascade 1-28
  - coefficients 1-3
  - comparison to IIR 2-17
  - convolution 1-3
  - convolution matrices 1-30
  - design 2-2
  - FIR design 2-17
  - fixed-point implementation 1-28
  - frequency response 1-14
  - group delay description 1-18
  - IIR design 2-4
  - implementation with `filter` 1-3
  - impulse response definition 1-12
  - initial conditions 1-6
  - lattice/ladder structures 1-28
  - models 1-23
  - order 1-3
  - phase delay definition 1-19
  - poles 1-24
  - second-order sections 1-28
  - specifications 2-8
  - state-space 1-25
  - time-domain representation 1-4
  - transfer functions representation 1-3
  - transients 1-11
  - transposed direct-form II structures 1-6
  - types 1-3
  - zero-phase implementation 1-9
  - zero-pole analysis 1-21
  - zeros 1-24
  - See also* FIR filters, IIR filters
- digital frequency A-1
- discrete cosine transforms
  - definition 7-38
  - energy compaction property 7-39
  - example 7-39
  - reconstruct signals 7-39
- discrete Fourier transforms 1-11
  - algorithms 1-35
  - definition 1-34
  - eigenvector equivalent 6-44
  - goertzel 1-36
  - IIR filter implementation 1-11
  - inverse two-dimensional 1-36
  - magnitude 1-35
  - phase 1-35
  - power spectrum estimation 6-9
  - signal length dependencies 1-35
  - spectral analysis 6-5
  - time-dependent 7-28
  - two-dimensional 1-36
  - See also* fast Fourier transforms
- discrete prolate spheroidal sequences. *See* `dpss` function
- discretization
  - bilinear transformations 2-48
  - filters 2-46
  - impulse invariance 2-47
- `dpss` function
  - example 6-28

**E**

- echo detection 7-24
- edge effects 1-11
- eigenanalysis 6-44
- eigenvector method 6-7
  - definition 6-43
  - spectral estimation 6-7
  - See also* multiple signal classification method
- elliptic filters
  - definition 2-11
- equiripple 2-24
  - Chebyshev Type I filters 2-10
  - Chebyshev Type II filters 2-10
  - Chebyshev windows 7-12
  - elliptic filters 2-11
- error minimization 2-24
  - weighted frequency bands 2-27
- estimation 6-7 6-29
  - cross spectral density 6-29
  - See also* parametric modeling
- export
  - filter 5-26

**F**

- fast Fourier transforms 1-34
  - example 1-35
  - frequency response 1-14
  - implementation 1-11
  - output 1-36
- fdatool
  - exporting to Simulink 5-29
- fdatool GUI
  - computing coefficients 5-12
  - design methods 5-8
  - exporting filters 5-26
  - filter architecture 5-23
  - filter design specification 5-8
  - filter implementation 5-23
  - filter order specification 5-9

- filter responses 5-13
- filters structure 5-23
- frequency response specification 5-10
- importing 5-39
- MATLAB code 5-34
- opening 5-6
- response type 5-7
- saving coefficients 5-26
- second analysis 5-13
- sessions 5-38

FFT. *See* fast Fourier transforms

- filter algorithm 3-6
  - choosing 3-6
- Filter block 5-29
- filter data 3-10
- filter design 5-2
  - customize algorithm 3-8
  - filter analysis 3-9
  - Filter Object 3-8
  - flow chart
    - flow diagram 3-2
  - process 3-2
  - specification 3-4
  - Specifications Object 3-4
  - sptool Filter Designer GUI 8-47
  - See also* fdatool GUI
- filter design parameters 3-4
- Filter Designer GUI. *See* fdatool GUI
- filter function
  - description 1-6
- filter response 3-4
- Filter Viewer
  - open 8-11
  - printing 8-24
- filters 1-5
  - analog 2-9
  - anti-causal 1-9
  - anti-symmetric 2-28
  - Butterworth (generalized) 2-15
  - C header file 5-32

- coefficients 1-3
- coefficients in `sptool` GUI 8-29
- convolution 1-2
- design 2-6
- discretization 2-46
- equiripple 2-24
- export 5-26
- filter and `filtfilt` functions
  - comparison 1-9
- filter function 1-4
- FIR design 2-24
- FIR single band 2-23
- frequency domain 1-10
- frequency transformations 2-44
- importing to `sptool` GUI 8-32
- initial conditions using filter function 1-6
- lattice/ladder 1-28
- linear phase 2-18
- linear prediction 7-14
- linear system models 1-24
- median filtering 7-29
- minimax 2-24
- order 1-3
- phase distortion removal 1-9
- phase modulation 7-27
- pole-zero editor 5-19
- sampling frequency 5-17
- saving 5-35
- second-order sections 1-28
- specifications 2-8
- `sptool` GUI Filter Designer 8-47
- types 1-3
- zero-phase implementation 1-9
- See also* `fdatool` GUI, FIR filters, IIR filters, digital filters, analog filters
- `filtfilt` function
  - filter function comparison 1-9
- FIR filters 2-17
  - arbitrary response 2-37
  - constrained least square 2-31
  - differentiators 2-30
  - equiripple 2-24
  - example 8-16
  - frequency domain 1-11
  - Hilbert transformers 2-28
  - IIR filter comparison 2-17
  - implementation 1-6
  - Kaiser windows 7-10
  - lattice/ladder 1-28
  - least square and equiripple comparison 2-25
  - least square multiband 2-34
  - least square weighted 2-35
  - linear phase 2-18
  - multiband 2-24
  - multiband example 2-23
  - reduced delay response 2-40
  - resample 1-8
  - `sptool` GUI Filter Designer 8-47
  - standard band 2-23
  - windowing method 2-20
- `fir1` function
  - example 2-22
- `firls` function
  - differentiators 2-30
  - `firpm` comparison 2-25
  - weight vectors 2-27
- `firpm` function
  - differentiators 2-30
  - example 2-25
  - `firls` comparison 2-25
  - Hilbert transformers 2-28
  - weight vectors 2-27
- `firpmord` function
  - example 2-18
- FM. *See* frequency modulation
- frequency
  - analog A-1
  - angular 2-2
  - center 2-46

- cutoff 2-44
- digital A-1
- estimation 6-43
- normalization 2-2
- Nyquist A-1
- vectors 2-27
- frequency domain
  - duality with time-domain 1-10
  - filters 1-10
  - FIR filtering 1-10
  - transformation functions 2-44
- frequency domain based modeling. *See*
  - parametric modeling
- frequency response 1-14
  - Bessel filters 2-12
  - Butterworth filters 2-9
  - Chebyshev Type I filters 2-10
  - Chebyshev Type II filters 2-10
  - elliptic filters 2-11
  - error minimization 2-24
  - evaluating 1-14
  - example 1-15
  - Kaiser window 7-9
  - linear phase 2-18
  - magnitude 1-17
  - monotonic 2-9
  - multiband 2-13
  - phase 1-17
  - plotting 1-15
  - sampling frequency 1-14
- freqz function
  - sampling frequencies 1-14
- From Disk radio button 8-36

**G**

- generalized Butterworth filters 2-15
- generalized cosine windows 7-6
- generalized filters 2-6
- Gibbs effect 2-21

- reduced by window 7-2
- group delay 1-18
  - comparison to phase delay 2-19
  - example 1-19
  - passband 2-12
- grpdelay function
  - example 1-19

**H**

- Hadamard transform 7-41
  - See also* Walsh transform
- hamming window function
  - comparison to boxcar 6-18
  - comparison to Hann 7-6
  - example 2-21
- hann window function
  - comparison to Hamming 7-6
- highpass filters
  - FIR example 2-23
- hilbert transform function
  - analytic signals 2-29
  - description 7-40
  - example 2-29
- homomorphic systems 7-24

**I**

- icceps function
  - example 7-27
- idct function
  - example 7-38
- ideal lowpass filters 2-20
  - See also* lowpass filters
- ifft function
  - example 1-36
- ifft2 function
  - example 1-36
- IIR filters 2-5
  - analog prototype 2-7



- Bessel 2-12
- Butterworth 2-9
- Chebyshev Type I 2-10
- Chebyshev Type II 2-10
- comparison 2-9
- comparison to FIR 2-4
- design 2-4
- elliptic 2-11
- Filter Designer GUI 8-47
- frequency domain implementation 1-10
- frequency response 2-14
- generalized Butterworth 2-15
- lattice/ladder 1-28
- maximally flat 2-15
- multiband 2-14
- order estimation 2-8
- plotting responses 2-13
- specifications 2-8
- Yule-Walker example 2-13
- zero-phase implementation 1-9
- See also* direct design
- image processing 1-36
- Import dialog box
  - sptool from disk 8-36
  - sptool from workspace 8-17
- impulse invariance
  - example 2-47
- impulse response 1-12
  - ideal 2-20
  - impulse invariance 2-47
- indexing 1-3
- initial conditions
  - example 1-6
  - using filtfilt function 1-10
- instantaneous attributes 7-41
- interval notation A-1
- inverse cepstrum, complex 7-27
- inverse discrete cosine transforms
  - accuracy of signal reconstruction 7-39
- inverse discrete Fourier transforms 1-34

- example 1-34
- two-dimensional 1-36
- invfreqs function
  - example 7-18
- invfreqz function
  - example 7-18

## K

- kaiser window function
  - discussion 7-8
  - example 6-20
  - FIR filters 7-10

## L

- ladder filters. *See* lattice/ladder filters
- Laplace transforms 1-31
- latc2tf function
  - example 1-30
- latcfilt function
  - example 1-10
- lattice/ladder filters 1-28
  - implementation 1-29
  - latcfilt function 1-30
- levinson function
  - example 7-15
  - parametric modeling 7-15
- line
  - drawing in FDATool 5-16
- line style 8-44
- linear models. *See* models
- linear phase filters 2-18
- linear prediction
  - modeling 7-14
- linear system transformations. *See* conversions
- lowpass filters
  - FIR 2-23
  - ideal 2-20
  - impulse invariance 2-47

- impulse response 2-20
- lp2bp function
  - example 2-45
- lpc. *See* prony function, linear prediction

## M

- magnitude
  - Fourier transforms 1-35
  - frequency response extraction 1-17
  - plots 8-56
  - transfer functions 6-29
- MAT-files
  - dps.mat 6-28
  - sptool GUI 8-36
- MATLAB code
  - generating in FDATool 5-34
- matrices
  - convolution 1-30
- matrix forms. *See* state-space forms
- maxflat function
  - discussion 2-15
- maximally flat filters. *See* maxflat function
- maximum entropy estimate 6-35
- medfilt1 function
  - example 7-29
- minimax method 2-24
  - FIR filters 2-24
  - See also* Parks-McClellan algorithm
- models 1-23
  - bilinear transformations 2-49
  - transformations 2-49
- modified covariance method 6-41
- modulate function
  - definition 7-30
  - example 7-31
  - time vector 7-31
- modulation 7-30
- moving-average (MA) filters 1-3
  - See also* FIR filters

- MTM. *See* multitaper method
- multiband filters
  - FIR 2-23
  - IIR 2-13
- multiple signal classification method (MUSIC)
  - discussion 6-7
  - example 6-43
- multiplicity of zeros and poles 8-55
- multirate filters 1-8
- multitaper method (MTM) 6-25
- MUSIC algorithm. *See* multiple signal classification method

## N

- nonrecursive filters. *See* FIR filters
- normalization 6-3
  - modified periodogram 6-18
  - periodogram bias 6-17
  - Welch's power spectral density 6-24
- Nyquist frequency A-1

## O

- order
  - estimation 2-8
- overlap-add method
  - FIR filter implementation 1-11

## P

- p-model. *See* parametric modeling
- Panner check box 8-44
- parametric modeling 7-13
  - applications 7-13
  - frequency domain based 7-18
  - linear predictive coding 7-14
  - Steiglitz-McBride method 7-17
  - summary 2-6
  - techniques 7-13
  - time-domain based 7-14

- parentheses A-1
  - partial fraction expansion 1-31
    - residue 1-26
  - passband
    - Chebyshev Type I 2-10
    - equiripple 2-11
    - group delay 2-12
  - pburg function
    - example 6-38
  - pcov function
    - example 6-41
  - periodogram function
    - discussion 6-9
  - phase
    - delay 1-19
    - distortion 1-9
    - Fourier transforms 1-35
    - frequency response 1-17
    - linear delay 2-19
    - transfer functions 6-29
    - unwrapping 1-17
  - plots
    - analog filters 2-13
    - coherence function 6-31
    - complex cepstrum 7-25
    - DFT 1-35
    - frequency response 1-15
    - group delay 1-19
    - magnitude 8-56
    - magnitude and phase 1-17
    - phase 1-17
    - phase delays 1-19
    - transfer functions 6-30
    - zero-pole 1-21
  - plug-ins 8-45
  - pmcov function
    - example 6-41
  - pole-zero editor 5-19
  - pole-zero filters. *See* IIR filters
  - poly function
    - example 1-24
  - polynomials
    - division 7-35
    - roots 1-24
  - polyphase filtering techniques 1-8
  - power spectral density 6-5
    - Burg estimation example 6-37
    - covariance estimation example 6-41
    - multitaper estimation example 6-25
    - MUSIC estimation example 6-43
    - periodogram bias 6-17
    - periodogram normalization 6-17
    - plots 8-13
    - sptool GUI 8-34
    - units 6-6
    - Welch's bias 6-24
    - Welch's estimation bias 6-24
    - Welch's estimation example 6-21
    - Welch's normalization 6-24
    - Yule-Walker estimation example 6-34
  - prediction filters 7-14
  - Preferences menu item 8-43
  - Print dialog box 8-26
  - print to figure 5-18
  - prolate-spheroidal windows 7-8
  - prony function
    - example 7-16
  - Prony's method. *See* prony function
  - pulse position modulation 7-31
  - pyulear function
    - Burg comparison 6-38
    - example 6-35
- R**
- radar applications 7-28
  - range notation A-1
  - rceps function
    - example 7-26
  - realize data 3-10

- rectangular windows 7-3
- rectwin function
  - example 7-3
- recursive filters. *See* IIR filters
- references
  - special topics 7-47
  - statistical signal processing 6-46
- reflection coefficients 1-29
  - definition 1-28
- rejection area 5-16
- resample function
  - example 7-21
- resampling. *See* decimation, interpolation
- residue forms. *See* partial fraction expansion
- roots
  - polynomials 1-24
- rulers
  - sptool GUI 8-44
- running average 7-16

## S

- sampling frequency 5-17
  - FIR filters 1-8
  - freqz function 1-16
  - irregularly spaced data 7-23
  - range 1-16
  - resampling discussion 7-21
  - spacing 1-16
    - using upfirdn function 1-8
- saved filters 5-35
- saving data
  - Spectrum Viewer 8-30
- second-order sections 1-27
  - conversion to in fdatool 5-25
  - matrices 1-27
  - sptool GUI 8-34
- Signal Browser 8-7
  - axis labels 8-44
  - markers preferences 8-44
  - overview 8-7
  - Panner preferences 8-44
  - printing 8-24
  - signals, measuring 8-41
  - zooming, preferences 8-44
- signals 2-29
  - analytic 7-40
  - applications 7-40
  - array 8-7
  - auto- and cross-correlation 6-4
  - carrier 7-30
  - DCT coefficients reconstruction 7-39
  - differentiators 2-30
  - measurements 8-41
  - properties 7-40
- Simulink
  - exporting from FDATool 5-29
- Slepian sequences
  - See* discrete prolate spheroidal sequences 6-28
- sonar applications 7-28
- spectral analysis 6-5
  - cross spectral density 6-29
  - power spectral density 6-5
  - PSD 6-5
  - Spectrum Viewer 8-13
  - See also* spectral estimation
- spectral density 6-5
  - measurements 8-41
  - plots 8-13
  - Spectrum Viewer 8-13
  - units 6-6
  - See also* cross spectral density; power spectral density
- spectral estimation 6-9
  - Burg method example 6-37
  - Welch's method bias 6-24
  - Welch's method discussion 6-21
  - Welch's method example 6-7
  - Yule-Walker AR method example 6-35

- spectrogram
  - definition 7-28
- spectrogram function
  - example 7-28
- spectrum
  - mask 5-16
- Spectrum Viewer 8-13
  - activating 8-13
  - axis parameters 8-44
  - markers, preferences 8-44
  - measurements 8-41
  - opening 8-13
  - overview 8-13
  - printing 8-26
  - rulers 8-41
  - spectra structures 8-30
  - spectral density plots 8-13
  - windows 8-14
  - zooming 8-44
- spectrum.mtm function
  - example 6-26
- speech processing
  - parametric modeling 7-13
  - resampling 7-22
- spline function 7-23
- sptool GUI
  - colors, customizing 8-44
  - context-sensitive help 8-6
  - customizing 8-43
  - data objects 8-39
  - data structures 8-3
  - editing 8-40
  - example 8-16
  - exporting data 8-27
  - filter coefficients 8-50
  - filter design 8-18
  - filter importing 8-32
  - filter parameters 8-29
  - filter saving 8-28
  - filter transfer functions 8-29
  - filtering 8-20
  - filters 8-32
  - help 8-6
  - Import dialog 8-17
  - importing filters and spectra 8-32
  - importing signals 8-16
  - items, selecting 8-39
  - line style 8-44
  - MAT-files 8-36
  - MATLAB workspace 8-3
  - multiselection of items 8-39
  - operation 8-3
  - preferences 8-43
  - printing 8-26
  - rulers 8-41
  - sample frequency 8-51
  - saving 8-27
  - second-order section forms 8-34
  - signal analysis 8-22
  - signal measurement 8-41
  - signal playing 8-23
  - sound 8-23
  - spectra analysis 8-24
  - spectra import 8-34
  - spectral densities import 8-32
  - spectral densities plot 8-34
  - Spectrum Viewer 8-24
  - state-space forms 8-33
  - transfer functions 8-33
  - tutorial 8-2
  - workspace 8-3
  - zero-pole-gain forms 8-33
- standards, digital audio tape 7-22
- startup transients 1-10
- state-space forms 1-25
  - continuous time 1-31
  - scalar 1-25
  - sptool GUI 8-33
- statistical operations 6-2

*See also* autocorrelation sequences;  
cross-correlation sequences; cross-covariance

Steiglitz-McBride method  
  example 7-17

stmcb function  
  example 7-17

stopband  
  Chebyshev Type II 2-10  
  elliptic 2-11

structures  
  conversion 5-24  
  conversion round off 1-33  
  lattice/ladder 1-28  
  transposed direct-form II 1-6

system identification 7-16

## T

tapers (PSD estimates) 6-25

taps 2-18

tf2latc function  
  example 1-29

tfestimate function  
  example 6-29

time series attributes 7-41

time-domain based modeling. *See* parametric modeling

transfer functions 1-3  
  coefficients 8-29  
  discrete time models 1-24  
  factoring 1-24  
  filter coefficients 8-50  
  partial fractions 1-26  
  sptool GUI 8-33  
  Welch's estimation 6-29  
  zero-pole-gain forms 1-24

transformations  
  bilinear 2-48  
  frequency 2-44  
  models 1-32

transforms 7-36  
  chirp  $z$ -transforms (CZT) discussion 7-36  
  discrete Fourier 1-34  
  Hadamard 7-41  
  Hilbert discussion 7-40  
  inverse discrete cosine discussion 7-38  
  Walsh 7-41

transients 1-11

transition band 2-25

transposed direct-form II structure 1-6

triang triangle window function  
  Bartlett comparison 7-4

two-dimensional operations 1-36

## U

units of power spectral density (PSD) 6-6

unwrap function  
  example 1-17

upfirdn function  
  example 1-8  
  resampling 7-23

## V

variables  
  load from disk 8-36

variance 6-4

vco  
  example 7-34

vectors  
  frequency 2-27  
  indexing 1-3

voltage controlled oscillators  
  example 7-34

## W

Walsh transform 7-41

Welch's method 6-21  
  AR Yule-Walker comparison 6-35

- bias and normalization 6-24
- Burg comparison 6-39
- MTM comparison 6-28
- nonparametric system identification 6-29
- power spectral density estimation 6-29
- windows
  - Bartlett comparison 7-4
  - Blackman comparison 7-6
  - boxcar 2-20
  - Chebyshev overview 7-12
  - cosine 7-6
  - filters 2-20
  - finite impulse response filters 2-20
  - `fir1` function 2-23
  - Hamming discussion 7-6
  - Hamming rectangular example 6-18
  - Hamming ringing example 2-21
  - Hann example 7-6
  - Kaiser discussion 7-8
  - Kaiser example 6-20
  - multiband FIR filters 2-23
  - prolate-spheroidal 7-8
  - rectangular example 2-20
  - shapes 7-3
  - single band FIR filters 2-23
  - spectral leakage 6-12
- Workspace Contents list 8-17

**Y**

- Yule-Walker AR method
  - description 6-34
  - example 6-38
  - Welch's method comparison 6-35
- `yulewalk` function
  - example 2-14

**Z**

- z-transforms
  - chirp  $z$  7-36
  - definition 1-24
  - discrete Fourier transforms 1-34
  - equation 1-3
- zero frequency component, centering 1-36
- zero-pole
  - multiplicity 8-55
  - plots 1-21
  - transfer functions 1-24
- zero-pole-gain 1-24
- zero-pole-gain forms 1-31
  - `sptool` GUI 8-33
- zoom
  - `sptool` GUI 8-44